



The 6Cs Design Guide



This is a revised edition. Please follow the links below for lists of changes:

- [Complete list of changes 2013](#)
- [Complete list of changes 2012](#)
- [Complete list of changes 2011](#)
- [Changes up to 2008 through to 2010](#)
- [Changes 2004 - 2007](#)

'The 6Cs Design Guide deals with highways and transportation infrastructure for new developments in areas for which Derby City Council, Derbyshire County Council, Leicester City Council, Leicestershire County Council and Nottinghamshire County Council are the highway authorities (Please see [Figure IN1](#)).

It replaces the previous authorities individual documents. It is copyrighted and may not be used by other authorities for the purposes of development control. Rutland County Council District Council has its own, separate, adopted guidance documents. For developments in Rutland, you must contact that authority and refer to its documents and not to the 6Cs Design Guide'.

Please note: the companion documents, 'Specifications for highway works for new developments' and 'Standard conditions applying to highway works for new developments', are presently only available in Portable Document Format (PDF).

Contents

- [The 6Cs design guide \(6CsDG\) Foreword](#)
- [Part 1: Introduction:](#) Provides important information about this document and about us, the Highway Authority, and our policies and objectives (including our Highways

Development Control and Access to Road Network policies). Please read in full first if you have not used this document before.

- [Part 2: Preparing development proposals](#): Guidance on preparing and considering proposals. Explains when we normally require transport assessments, travel plans and other supporting information.
- [Part 3: Design guidance](#): Sets out our normal requirements, and is intended to help you design layouts that provide for the safe and free movement of all road users. Also covers parking for cars, service vehicles, cycles and motorbikes.
- [Part 4: Materials and construction](#): Sets out our normal requirements and how we will deal with alternative proposals. It also includes details on our commuted sums policy, including how we calculate them, what we normally charge them for and schedules of rates.
- [Part 5: Adopting new roads and the advance payments code](#): Guidance to help you get your roads adopted under Section 38 of the Highways Act. It also sets out our [advance payments code](#) procedure, which covers both roads that are to be adopted and those which are to remain private. Our fees and other payments are also set out.
- [Part 6: Working on existing highways - Section 278 procedures](#): Guidance to help the efficient construction of works affecting the existing public highway. Our fees and other payments are also set out.
- Part 7: Appendices
 - [Appendix A](#): Useful contact details, including our details and those for the planning authorities.
 - [Appendix C](#): Assessing the transport impacts of development proposals (includes some information on travel plans too). Explains how you should normally prepare an assessment, including guidance on preparing a scoping report and criteria for assessing traffic impacts.
 - [Appendix D](#): Additional information on safety audits, including when they should normally be carried out.
 - [Appendix E](#): Additional information on private area requirements. Explains why we normally require certain design features.
 - [Appendix F](#): Preservation of trees. Detailed guidance to determine which trees should be retained and how best to protect them during and after construction works.
 - [Appendix G](#): Landscaping on new developments, including advice on appropriate species to plant.
 - [Appendix H](#): Air quality management zones. Details of their location.
 - [Appendix I](#): Our other procedures. Details on other matters that may need to be taken into account in preparing development proposals, for example traffic regulation orders.
 - [Appendix J](#): Advance payments code (APC) - gives background information on the APC and how it is applied in Leicestershire.
 - [Appendix K](#): Tell us what you think - please complete the form included in this appendix if you have any comments on Htd. Any suggested changes will be considered through our review process, which is also included.
 - [Appendix L](#): Definition of streets
 - [Appendix M](#): The Department for Communities and Local Government (DCLG) research paper on residential car parking.
 - [Appendix N](#): 6CsDG Business plan.
 - [Appendix O](#): Pre application checklist.

- [Part 8: Glossary](#)
- [Part 9: Bibliography](#)

Companion documents to 'The 6Cs Design Guide'

- [Specifications for highway works for new developments - PDF](#)
- [Standard conditions applying to highway works for new developments - PDF](#)
- [Standard drawings](#)

The 6Cs Design Guide

Foreword



The region is currently facing many challenges, including the economic downturn, population growth, health and obesity issues, climate change and changes to government policies e.g. the planning system. We must deal with these challenges whilst ensuring that their impact on our transport system, communities, individuals and the environment is minimised.

A regional design guide helps to respond to these issues – it provides clear and common guidance to developers across the region, whilst allowing flexibility to meet local requirements. It assists in the delivery of housing growth, encourages sustainable development and minimises the impact of development on the highway. It also plays a vital role in the highway development control process.

What is highway development control?

The aim of highway development control is to ensure that new development is delivered in ways that promote sustainable travel and safeguard the efficient and safe functioning of the transport system.

The Local Planning Authority (LPA) is responsible for determining most planning applications for housing and employment sites. They manage and administer the planning process and make decisions on the planning application.

There are four stages in the planning process (pre-application, application, enforcement and appeal). At a very early stage (i.e. before submitting a formal application) applicants are *advised* to discuss their proposed application with the Local Planning Authority (LPA), in addition to discussing any highway and transportation issues with the Local Highway Authority. [Part 1 \(IN2\)](#) of the guide encourages early engagement, which can help to resolve issues before they become more difficult to deal with.

At certain stages in the planning process the Local Planning Authority will formally seek the views of other authorities and bodies on the development proposal (these are known as statutory consultees). Their views help the Local Planning Authority to make an informed decision about the development.

The 6Cs Design Guide

One of these statutory consultees is the Local Highway Authority (LHA). The LHA assesses the proposals against highway policies and standards, then gives their views on the impact of the development on the highway to the Local Planning Authority. [Part 1 \(IN4\)](#) of this guide provides clear advice on highway development control.

The Local Planning Authority considers and weighs up all of the responses before coming to a final decision on the development. To check who the Local Planning Authority (LPA) and Local Highway Authority (LHA) are for the 6Cs authorities see [Appendix A](#): Useful contact details.

What is the 6Cs design guide?

For many years there's been an ambition to develop a regional design guide, which would deal with highways and transportation infrastructure for new developments across the region. It was felt that a regional design guide would bring numerous benefits, including consistency and efficiency.

Three city councils and three county councils (known collectively as the 6Cs) have now come together to achieve their shared goal of developing and maintaining a regional design guide. The 6C authorities consist of Derby City Council, Derbyshire County Council, Leicester City Council, Leicestershire County Council, Nottingham City Council and Nottinghamshire County Council. All six authorities have now adopted the design guide as policy.

The guide is web-based, enabling the 6Cs authorities to provide up-to-date information to users.

This regional guide is based on a document originally developed by Leicestershire County Council called 'Highways, transportation and development' (Htd). In recognition of this joint approach Htd has been renamed the 6Cs design guide (6CsDG).

Opportunities provided by the 6Cs design guide

The guide presents a number of significant opportunities, including:

- Making the best use of resources and providing cost and efficiency savings without affecting service provision e.g. by minimising duplication and sharing costs.
- Assisting developers, by providing clear and common guidance.
- Assisting in the delivery of housing growth and securing developer funding.
- Developing joint working practices
- Sharing expertise and best practice.
- Providing a consistent approach, whilst allowing flexibility to meet local requirements.
- Providing a strong 'joint-voice', strengthening our ability to influence the formation of policy at a local, regional and national level.

Benefits and achievements of the 6Cs design guide

Use of the guide has already produced numerous benefits and achievements, including:

- *Reducing costs.* The guide has enabled us to deliver efficiency savings without affecting service delivery (based on the initial costs for developing and producing Htd it would now cost at least £500,000 for all the 6C authorities to set up separate guides).

The 6Cs Design Guide

- *Sharing costs.* Ongoing maintenance and development costs for the web-based document are now shared amongst all 6Cs authorities.
- *Reducing work.* Work already undertaken by individual 6Cs authorities has been utilised for developing the guide, reducing the need to commission additional work.
- *Sharing information.* Skills, knowledge and best practice from across the 6Cs authorities has been utilised to help develop the guide e.g. technical specialists from individual 6Cs authorities have been utilised when updating the guide.
- *Influencing national policy.* Expertise from the 6Cs authorities has been utilised to help develop national guidance e.g. during the development of the first DfT *Manual for Streets* and the development of ADEPTs (formerly the County Surveyors Society) 2009 *Commuted Sums for Maintaining Infrastructure Assets* guidance.
- *Promoting high quality development.* The guide has enabled the 6Cs authorities to promote high quality development whilst resisting proposals which could have resulted in negative impacts. At public enquiries Planning Inspectors continue to attach weight to the policies set out in the guide.

How the 6Cs design guide is managed

Management board

A management board has been formed to direct the design guides ongoing development and management. The 6Cs management board makes decisions about the guide e.g. whether updates, changes, further research or links to other documents are required.

The management board consists of officers from each of the 6Cs authorities who have adopted, or are in the process of adopting, the guide. It is chaired by an independent Chair. Contact information for the board is provided below.

Officers on the board take responsibility for making decisions or, where appropriate, referring issues back to their respective authorities.

Chair: Steve Clarke, Edwards & Edwards	steve.clarke@eaeconsultancy.co.uk
Derby City Council, Rob Waite	customerservices@derby.gov.uk
Derbyshire County Council, Kevin Barton	etc.developmentcontrol@derbyshire.gov.uk
Leicester City Council, Simon White	simon.white@leicester.gov.uk
Leicestershire County Council, Joanne Eynon	hdc@leics.gov.uk
Nottingham City Council, Lisa Guest	lisa.guest@nottinghamcity.gov.uk
Nottinghamshire County Council, Clive Wood	hdc.south@nottsc.gov.uk hdc.north@nottsc.gov.uk
Cheshire East Council, Simon Skates	simon.skates@cheshireeast.gov.uk

Process for updating the guide

All decisions affecting the guide, including amendments and updates, are voted on. Each 6Cs authority has one vote on the board and decisions are based on a majority vote.

The 6Cs Design Guide

Leicestershire County Council currently hosts and manages the 6CsDG website on behalf of the 6C authorities. All changes are logged on the website at [Complete list of changes 2011](#).

Fees

Authorities wishing to adopt the guide pay an initial joining fee plus an annual fee. These fees cover the costs of managing the website, updates, further development of the guide, specific projects relating to the guide and, where appropriate, commissioning additional resources to facilitate these processes.

Leicestershire County Council currently manages these fees on behalf of the board.

Using / adopting the guide

The guide is a policy document for the 6Cs authorities. It is intended for use by developers within the 6Cs area.

The 6CsDG is copyrighted and may not be used by other authorities for the purposes of development control. For developments in other areas developers must contact that authority and refer to its documents and not to the 6CsDG.

If other authorities would like to use part, or all, of this guide for the purposes of development control, or would like to discuss formal adoption of the guide, please contact the Chair of the management board.

How the guide will continue to be developed

The management board will:

- Ensure that the guide remains fit for purpose.
- Ensure that the guide is kept up-to-date and in-line with current policy and guidance.
- Review the content, format and presentation of the guide, where appropriate.
- Continue development of the guide.
- Ensure that the approach to development is coordinated and efficient.
- Inform other authorities and organisations about the guide.

How you can help

You can help to keep the guide up-to-date and fit for purpose by:

- advising us of any typos / errors
- suggesting improvements and areas for future development
- suggesting amendments to the website which would make it easier to use
- sharing best practice
- advising us of anything that could impact on the guide.

If you'd like to raise any issues please complete the 'Your views' form in [Appendix K](#)

Pdf version of the [6CsDG Foreword](#)

The 6Cs Design Guide

Part 1: Introduction

- [Section IN1: Document status](#)
- [Section IN2: Our responsibilities](#)
- [Section IN3: About this document](#)
- [Section IN4: Our highways development control policy](#)
- [Section IN5: Our access to the road network policy](#)
- [Section IN6: Sustainability Standards for Residential Developments](#)
- [Section IN7: About the Highways Agency](#)

Section IN1: Document status

1.1 This document was adopted as Leicestershire County Council policy by the December 2007 meeting of the full County Council. It was adopted as Leicester City Council policy with effect from 1st January 2008. Derbyshire County Council has adopted this document as interim guidance with effect from 31st January 2008. Nottinghamshire County Council adopted the guide on the 1st April 2009. Derby City Council adopted the guide in Autumn 2010.

Section IN2: Our responsibilities

1.2 We, the County Councils and City Council, are the highway authorities for the areas shown in Figure IN1. The unitary authorities of Rutland, Derby City and Nottingham City fulfil this role in their respective areas.

Note: This is the first version of 6CsDG to be jointly used by Leicestershire, Leicester City, Derbyshire, Nottinghamshire Councils. All references to 'us', 'we', 'our' and so on means Leicestershire County, Leicester City, Derby City, Derbyshire Council and Nottinghamshire County unless otherwise indicated. However, you will still need to contact Leicestershire County Council officers to discuss highway issues in the area for which it is responsible and likewise Leicester City, Derby City, Derbyshire County and Nottinghamshire officers if you have any questions about highway matters relating to developments in their respective areas.

The 6Cs Design Guide

Figure IN1

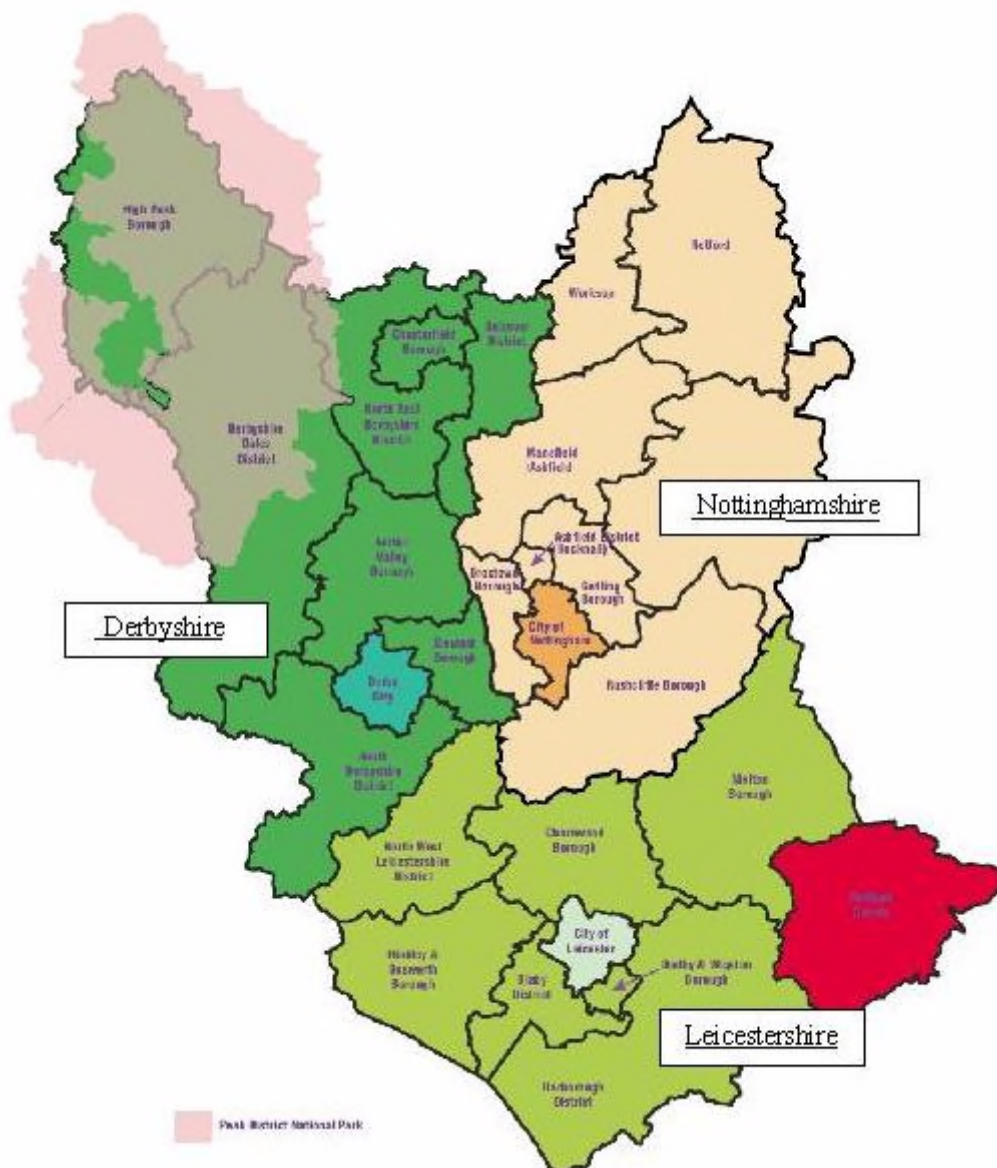

1.3 Please see [Part 7, appendix A](#) for planning authority contact details.

Leicestershire County Council

1.4 Leicestershire County Council is responsible for a range of highways and transport issues including:

all publicly-maintained highways in Leicestershire except for the M1, M6, M42, M69 motorways, and the A1, A5, A42, A50 west of M1 Junction 24 and A52 which are the responsibility of the Highways Agency (see [Section IN5](#)). (Note: Please see our ['Highways Status Search'](#) page for details of which existing roads are adopted);

The 6Cs Design Guide

- providing socially-necessary local bus services, publishing bus and bus information strategies and promoting high-quality rural and urban services that encourage greater use of public transport
- preparing the Leicestershire [Local Transport Plan](#)

Our Environment and Transport Department deals with those roads we are responsible for. Within that department, the Transport Policy and Strategy Group is responsible for considering how development proposals will affect the highways and transportation infrastructure. It deals with all highways and transportation matters, including:

- discussions with developers before they submit planning applications;
- making recommendations on applications (highway observations) to planning authorities;
- construction and [adopting](#) works for new development;
- [commuted sums](#); and
- travel plans.

The Department works closely with other departments within the County Council and we often work with the City Council on development proposals which will have a major impact on both County and City roads. You should contact the Transport Policy and Strategy group if you want to discuss highways and transportation aspects of a development proposal. You can find contact details in [Part 7, appendix A](#).

Leicester City Council

1.5 Leicester City Council is responsible for a range of highways and transport issues, including

- all publicly-maintained highways in the City of Leicester;
- preparing the [Leicester Local Transport Plan](#)
- The City Council's Regeneration, Highways and Transportation Division deals with those roads we are responsible for. Within this Division, the Transport Strategy Section is responsible for considering how development proposals will affect the City's highways and transportation infrastructure. It deals with all highways and transportation matters, including:
 - discussions with developers before they submit planning applications;
 - making recommendations on applications (highway observations) to planning authorities;
 - adopting roads in new development;
 - travel plans; and
 - [commuted sums](#)

The Section works closely with other departments within the City Council and we often work with the County Council on development proposals which will have a major impact on both City and County roads. You should contact the Transport Strategy Section if you want to discuss highways and transportation aspects of a development proposal in the City. You can find contact details in [Part 7, appendix A](#).

Derbyshire County Council

The 6Cs Design Guide

Please refer to www.derbyshire.gov.uk/transport for details of our roles and responsibilities.

Nottinghamshire County Council

Nottinghamshire County Council is responsible for a range of highways and transport issues including:

- all publicity-maintained highways in the county except for the M1 motorway, and the A1, A46, A453, and A52 which are the responsibility of the Highways Agency (see Section IN5).
- providing socially-necessary local bus services, publishing bus and bus information strategies and promoting high-quality rural and urban services that encourage greater use of public transport; and
- preparing the Local Transport Plan

Our Communities Department deals with those roads we are responsible for. Within that department, issues relating to either transport or planning and how development proposals will affect the highways and transportation infrastructure are dealt with between Highways and Planning & Sustainability Divisions. The former of these largely provides the delivery, whilst the latter provides the strategy and direction. One specific group "Local Transport Plans and Programmes" within Planning & Sustainability deals with all strategic highways and transportation matters, including:

Development Control

- discussions with developers before they submit planning applications;
- making recommendations on applications (highway observations) to planning authorities;
- adopting works for new development; and
- commuted sums

Transport and Environmental Programmes

- project management of significant and major schemes;
- delivery of environmental improvement schemes; and
- partnership working

Local Transport Plans

- transport strategy review;
- production of LTPs and delivery reports;
- development of local transport schemes; and
- travel plans.

The Divisions works closely with other divisions and departments within then County County and we often work with the City Council on development proposals which will have a major impact on both County and City roads. You should contact the Development Control team if you want to discuss highways and transportation aspects of a development proposal. You can find contact details in [Appendix A](#).

The 6Cs Design Guide



Section IN3: About this document

- [Background](#)
- [Our general approach](#)
- [Applying the guidance](#)
- [Developing the document](#)

Background

1.6 'Highways, transportation and development' (Htd) replaces the original publication Highway Requirements for Development, which applied in Leicestershire and Leicester City, Derbyshire County Council's publication Roads in Housing; and Nottinghamshire County Council's publication The Highway Design Guide 1999. This is an interim version, published to ensure that Htd reflects latest national guidance pending a more comprehensive review. It:

- reflects the Government's most recent planning policy and guidance, particularly [PPS3](#), and its companion guide '[Better places to live by design](#)', and the [Manual for Streets](#) (MfS)* , as well as [PPG13](#).
- reflects initiatives that continue to emerge as a result of the publication of research reports '[Paving the Way](#)' and '[Better Streets, Better Places](#)' (a research project that we took part in, see paragraph 1.7).
- reflects the [Guidance on Transport Assessments](#) published by the Department for Communities and Local Government; and
- is supported by local policies and strategies, including the [Local Transport Plan](#).

*Following publication of the MfS, we are conducting a two stage review of Htd. This version reflects the outcomes of stage one of our review. Further changes are likely to be made in response to the MfS in stage two of the review, although this has yet to be timetabled.

1.7 Htd was originally prepared by Leicestershire County Council after consulting widely with others. This included:

The 6Cs Design Guide

- carrying out initial 'fact-finding' consultations with a wide range of public and private bodies to seek views on 'Highways Requirements for Development' document;
- carrying out a survey of around 2900 Leicestershire households in developments laid out in line with the standards contained in the 'Highway Requirements for Development' document;
- actively taking part in the Office of the Deputy Prime Minister's research projects '[PPG3](#) and Highway Adoption Procedures' (which resulted in publication of '[Better Streets, Better Places](#)') and on residential parking; and in the Government's national project on [commuted sums](#).
- consultations with other highway authorities in the region, both directly and through the East Midlands Development Control Forum and Midlands Service improvement Group;
- organising regional meetings on [commuted sums](#) for future maintenance and on shared-surface roads and Home Zones; and
- holding a six-week consultation covering around 150 public and private bodies, including all Leicestershire planning authorities and many development companies.

1.8 Please see Part 7, appendix B for further details of all the above.

Our general approach

1.9 'Highway Requirements for Development' (LCC and Leicester City) Roads in Housing (DCC) and the Highway Design Guide (NCC) offered developers a clear, structured approach to highway design. But there is now a move towards:

- developments with more individuality and less of a 'one size fits all' approach;
- developments that better reflect and respect local character, for example in terms of layout and architecture;
- developments that better provide for local needs, for example in terms of the shopping or play facilities that they provide;
- higher-quality developments that enhance their surroundings and provide a safe, accessible and attractive environment in which to live, work and play.

1.10 Guidance that contains too many unnecessary rules and directions can inhibit innovation for residential layouts and frustrate the principles of PPS3 housing. It is important that new developments reflect local character and distinctiveness. So, this document will provide you with greater flexibility. In line with our general policies and objectives, it sets out guidance on a range of design elements, materials and landscaping that you can select when you are putting together your development proposals. It also offers flexibility so new or unusual design elements or materials not covered by the guidance can be considered.

1.11 However, this approach places greater onus on you to demonstrate that your proposals will operate safely and satisfactorily and meet our policies and objectives because you will not be sticking to a rigid set of guidelines.

1.12 We recognise that you may need to carry out more detailed investigations at the pre-planning application stage. But the guidance and procedures set out in this document are intended to help you to prepare your development proposals. And, if you can agree proposals both with us and the planning authority at the pre-application stage, this should

The 6Cs Design Guide

save time taken during the planning application stage, the works' technical approval stage and the construction stage.

1.13 Figure IN2, below, shows how the various parts of this document relate to the overall development process, from initially considering the site through to completing works. You should follow it so your development proposals progress efficiently.

Figure IN2 Overall development procedure

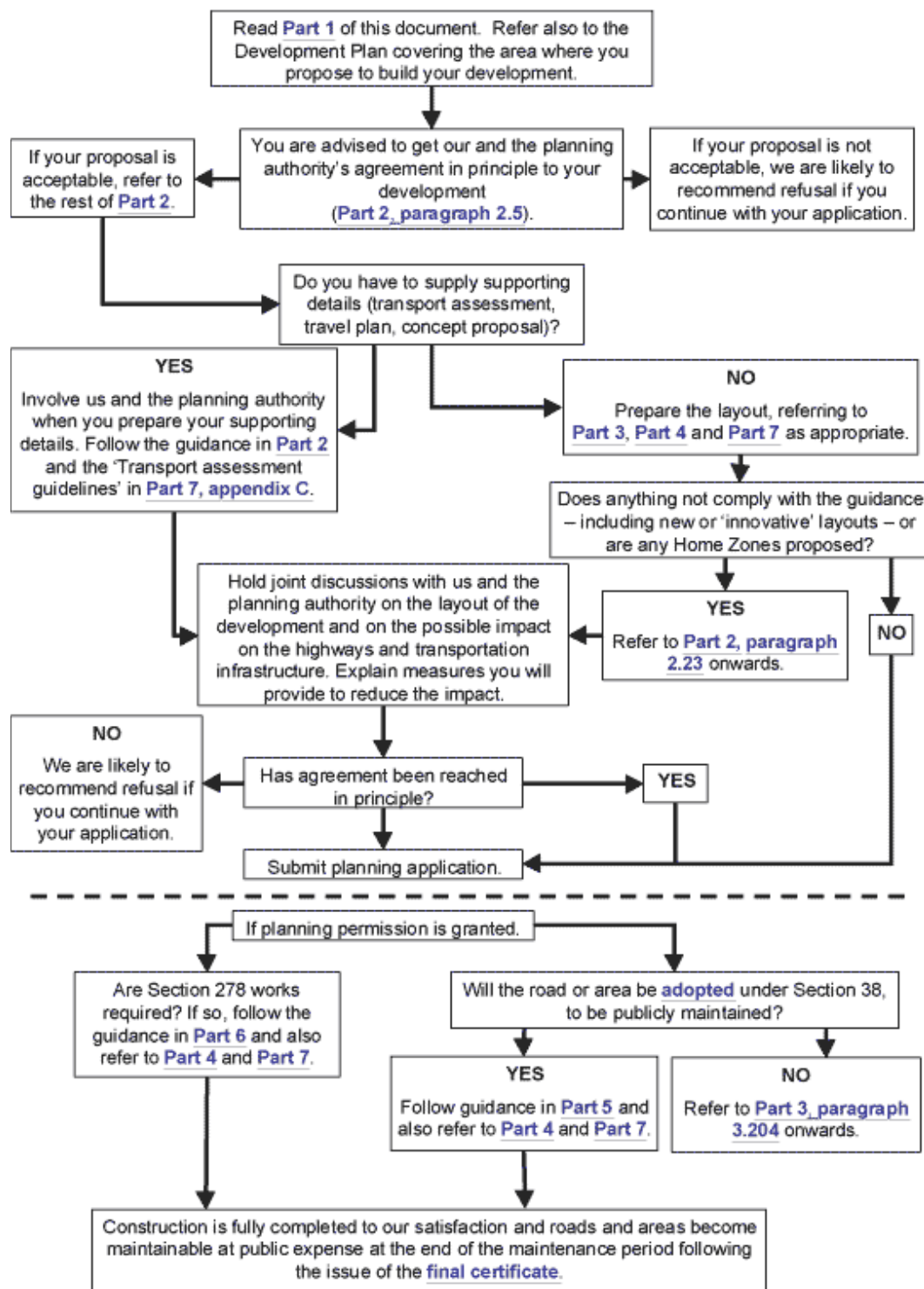

The 6Cs Design Guide

Note: Please contact County Council officers to discuss highway issues in the area for which it is responsible and Leicester City Council officers if you have any questions about highway matters relating to developments in the City. Similarly, please contact Derbyshire and Nottinghamshire officers regarding processes and procedures in their areas. We are able to provide you with details of how to obtain information relating to personal injury accidents for which we may charge a fee.

Applying the guidance

1.14 The guidance in this document applies to:

- roads (streets) in residential areas or; areas of mixed residential / local facilities as defined in [appendix L](#) and roads serving employment and commercial developments
- the overall development concept in terms of site access and highways and transportation impacts;
- areas to be [adopted](#) as publicly-maintained highways;
- the safety, ease of access to, and future maintenance responsibilities of areas not for adoption; and
- impacts of new developments on existing highways and transportation infrastructure.

1.15 We recognise that due to conditions at a site it may sometimes be difficult to comply with the guidance, particularly on urban, [brownfield sites](#). We also recognise that the Government and planning authorities are encouraging new, innovative residential layouts that reflect local character while providing for more houses.

1.16 So, if you present an acceptable case with supporting evidence that explains why you are proposing a layout that is not explicitly covered by these guidelines, we will consider it if:

- the proposals meet the overall [policies and objectives](#) set out in this document (refer to [Section IN4](#) onwards);
- also meet any other policies and objectives of the relevant highway authority;
- you approach both us and the planning authority for early joint discussions, to make sure that we can consider matters before you prepare any layout proposals; and
- you supply a concept proposal and full supporting details in line with [Part 2](#) of this document, and in particular [paragraphs 2.17](#) onwards.

1.17 You must start thinking about and preparing the required details as soon as possible, and certainly before you submit a planning application. Otherwise, even if the development is granted planning permission, there is no guarantee that we will agree to [adopt](#) any roads or areas.

1.18 When you prepare the required details, you should work closely both with us and the planning authority. You are likely to find that planning authorities will not favour developments that lack quality layout and design.

The 6Cs Design Guide

Developing the document

1.19 Long-term experience of reduced off-street parking, Home Zones and 'innovative' (unusual) residential developments is limited. There is still much to learn about:

- public opinion of these concepts;
- how safely the layouts will operate; and
- how easily they can be maintained.

What evidence there is suggests there have been some successes, but problems have been identified too, for example, in achieving low vehicle speeds in Home Zones and residents' concerns about on-street parking.

1.20 There are also still issues relating to national guidance on the design of residential streets, for example in terms of shared surfaces and providing for those with disabilities. Guidance can also be contradictory, for example, on how many dwellings can be served by a Home Zone.

1.21 To try and address some of these issues, we will continue to work with other highway authorities, planning authorities and developers to share, learn and develop good practice. We will also try to take part in any national research that is carried out.

1.22 If you have examples of what you consider to be good practice that you are willing to share, please send us details either by e-mail to HTD@leics.gov.uk or by post to Leicestershire County Council, Transportation Planning Group at the address given in the contact details in [Part 7, appendix A](#).

**Leicestershire County Council, working in partnership with the other authorities, is currently responsible for the on-going maintenance of the document, including coordination of examples and user comments. If you have any comments about how we can improve Htd, please let us know by filling in the form at [Appendix K](#). We will consider your comments as part of our next review. You can find details of our review process at [Appendix K](#).*

1.23 We will regularly review this document to make sure that it:

- contains no errors or omissions;
- reflects good practice, operational experiences, national research and policy initiatives, and
- reflects any other relevant changes in circumstances.

If you have any comments about how we can improve Htd, please let us know by filling in the form at [Appendix K](#). We will consider your comments as part of our next review. You can find details of our review process at [Appendix K](#).

**Leicestershire County Council are currently responsible for the on-going maintenance of the document, including coordination of examples and user comments.*

The 6Cs Design Guide



Section IN4: Our highways development control policy

1.24 We will work with developers and planning authorities to make sure new development is only permitted:

- in areas where there is a choice of safe and accessible methods of transport for all road users (including pedestrians and cyclists);
- on roads suitable for the type of development; and
- if the environment is not harmed, including through increased congestion.

1.25 Any highway or transport infrastructure required to support the development must integrate with the existing infrastructure and be built in a way that enhances the quality of a development and does not place a burden on our resources.

1.26 We aim to meet the following specific policy objectives.

- **Road and personal safety:** To achieve developments that:
 - are safe for all users;
 - promote road safety; and
 - reduce personal safety risks (whether real or imagined).
- **Accessibility:** To achieve developments accessible to all vehicles and people, including those with sensory and mobility impairments.
- **Sustainability:** To promote sustainable, high-quality alternatives to the private car and to encourage using sustainable materials wherever possible.
- **The impact on highways and transportation infrastructure:** To make sure the:
 - highways and transportation infrastructure is not adversely affected by developments, including safety and congestion; and
 - impact on people and the environment is minimised.
- **Design quality and future maintenance:** To achieve highway and transportation infrastructure that:
 - contributes to high-quality developments that can be properly and efficiently maintained; and
 - encourages development layouts to be [adopted](#), wherever possible, to safeguard [frontagers](#) interests.

Whole-life costs should be considered when materials and methods of construction are considered.

- **Occupants' and users' satisfaction:** To achieve developments that are appreciated by occupants and users and that meet their likely needs. This will

The 6Cs Design Guide

reduce the possibility of future complaints and problems, particularly in residential areas.

We will assess your development proposals against these objectives. Where we consider that your proposals have material implications, we will normally seek to resist your development proposals (for example, by recommending refusal of any planning application).



Section IN5: Our access to the road network policy

- [Principles](#)
- [Access to A- and B-class roads](#)
- [Access to other classified roads and unclassified roads](#)

Principles

1.27 To maintain safety and the free flow of traffic, policy in the past has discouraged new accesses onto A- and B-class roads and avoided increasing the use of existing accesses. For the future, and in line with an integrated transport policy, we will adopt a flexible policy on new connections to the road network. We will severely restrict access to the most important high-standard routes. Elsewhere, particularly in urban locations, in principle we will apply a more flexible approach. Please see [paragraph 1.29](#) onwards for full details.

1.28 Where access is acceptable to us in principle, we will normally expect its layout to comply with the [design guidance set out in Part 3](#). We will recommend refusal of any planning application that raises concerns about road safety. Approval for the access (and any associated development) will also depend on the planning authority where planning permission is required.

Access to A- and B-class roads

1.29 We will normally apply restrictions on new accesses for vehicles and the increased use of existing accesses on:

- roads with a speed limit above 40 mph (that is 50mph, 60mph or 70mph) or where measured vehicle speeds are in excess of 40mph;
- roads with a speed limit of 40mph or less which are essentially rural in nature;
- routes where the access would affect bus-corridor or bus-priority measures being put in place;
- roads that are at or near capacity (cannot carry more traffic); and
- roads where there is an existing problem with road safety.

The 6Cs Design Guide

1.30 Elsewhere, we will not normally restrict new accesses for vehicles, as long as they meet the conditions of [paragraph 1.28](#). Also, where a number of developments are proposed along a section of road, the risk of accidents occurring will be reduced if they are accessed from a service road with a single point of access on the main road.

1.31 If access to a development can be gained off a minor or side road, you should normally consider this option as preferable (with improvements to the junction of the minor side road with the main road as necessary).

Access to other classified roads and unclassified roads

1.32 New accesses for vehicles and the increased use of existing accesses will normally be restricted on:

- routes where there are proposals for bus-priority measures;
- roads where there is an existing problem with road safety;
- roads where there are proposals to establish quiet lanes; and
- other routes that are not suitable to carry the additional traffic and type of traffic from the development.

1.33 Elsewhere, new accesses for vehicles will not normally be restricted, if they meet the conditions of [paragraph 1.28](#). Also, if access to a development can be gained off a minor or side road, you should normally consider this option as preferable.

1.34 In rural areas, new accesses for vehicles and the increased use of existing accesses will not normally be resisted in principle to:

- land allocated for development in the local plan;
- agricultural land (that is remaining in agricultural use); and
- a new, better access to replace an existing one.

1.35 This is subject to the conditions in [paragraph 1.28](#).

IN6: Sustainability Standards for Residential Developments

Principles

1.36 Local Transport Plans (LTPs) set out transport policy for the relevant Highway Authority. Based on extensive evidence LTPs are aligned to national transport and planning policies, which are set out in the National Planning Policy Framework, Circulars and Guidance Notes.

1.37 To help deliver their LTP the Highway Authority will seek to ensure that new development is delivered in suitable locations and where the possibility of home-working is considered. These locations will be accessible by walking, cycling and public transport and will also have good access to key services, thereby reducing reliance on the private car. This is particularly necessary in order to:

- tackle the significant challenges posed by an increasing population
- meet the statutory CO₂ reduction requirements of the Climate Change Act

The 6Cs Design Guide

- tackle the health and social issues posed by a society that is becoming increasingly obese.

1.38 The overall aim of introducing these standards is to reduce the need to travel, particularly by car, and to promote more sustainable patterns of development.

1.39 The relevant Highway Authority will expect applicants, as part of their planning application, to demonstrate that their proposals are consistent with the approach set out in their LTP. As Highway Authorities may adopt different approaches, particularly in urban and rural areas, the guidelines below have been provided to give general guidance only.

You are advised to contact the relevant Highway Authority regarding their specific local sustainability standards ([see Appendix A](#)). Your attention is also drawn to the guidance in Part 3 (Section DG6: Public Transport).

General standards / guidelines

1.40 The following guidelines for sustainable development have been derived from national guidance and are based on the following assumptions:

- Average walk speed of 1.4m/s or 400m every 5 minutes¹
- Cycling speeds 12 mph/or 1.6km every 5 minutes²

1.41 Applicants should be aware of the following guidelines when submitting planning applications for new development within the Principal Urban Area³ (PUA) and Sub Regional Centres (SRC)⁴:

- Major employment areas should be within 2km (25min) walk or 5 km (15min) cycle ride. For applications involving new employment uses the same standards will apply in respect of major residential areas⁵
- Public transport to a main public transport interchange should be within 800m (10min) walk⁵

1.42 In more rural areas i.e. those outside the PUA and SRC the following will apply:

- Minimum of hourly bus service to SRC within 800m (10min) walk
- PUA / SRC within 5km
- 800m (10min) walk to village centre offering access to key services for example education facilities, local convenience shop/Post Office, public house, community facilities, health services, employment areas

If the location of your proposed development fails to meet these guidelines you should contact the relevant Highway Authority ([see Appendix A](#)). This will enable you to discuss your application in more detail before submitting a formal planning application.

Notes

1. 'Providing Journeys on Foot', Institute of Highways and Transportation.
2. Cycling England Design Guide.
3. PUA: Identified in the Regional Spatial Strategy for the East Midlands (RSS8). Although, through the Localism Act, Regional Spatial Strategies are being

The 6Cs Design Guide

abolished the principles of locating development in the PUAs and SRCs is likely to remain the same i.e. significant levels of new development should be concentrated in the PUA.

4.SRC: Identified in the Regional Spatial Strategy for the East Midlands (RSS8).

Although, through the Localism Act, Regional Spatial Strategies are being abolished the principles of locating development in the PUAs and SRCs is likely to remain the same i.e. appropriate development of a lesser scale should be located in the SRC.

5.The distances / times quoted above should be viewed as maximums. In assessing them for your particular development proposal, you should take into account such other factors as may be appropriate, for example the availability of pedestrian footways, street lighting, cycle lanes and gradients / terrain.

Section IN7: About the Highways Agency

1.43 The Highways Agency, which is an agency of the [Department for Transport](#) is responsible for the motorway and trunk road network in England. Its stated aim is "safe Roads, Reliable Journeys, Informed Travellers".

1.44 The Highways Agency has its own approach to considering the impacts of development proposals on roads it is responsible for. It also has its own requirements where it is necessary to alter or improve one of its roads to accommodate a development.

1.45 If your development proposals require changes to a road the Highways Agency is responsible for, you will need to complete a legal agreement with the Agency before you can carry out the works. (This is in addition to any agreement that you might need to enter in to with us.)

1.39 Please see [Appendix A](#) for contact details for the Highways Agency.

The 6Cs Design Guide

Part 2: Preparing development proposals



- [Section PDP1: Introduction](#)
- [Section PDP2: Our requirements in general](#)
- [Section PDP3: The initial preparation stages](#)
- [Section PDP4: The concept proposal and supporting information](#)
- [Section PDP5: Agreement in principle](#)

Section PDP1: Introduction

2.1 You can apply the guidance in this document to a wide range of developments, for example, from a single house to a housing estate or from an industrial unit to a business park. The amount of detailed work required for each development proposal will vary depending on its scale and impact on the surrounding highways and transportation infrastructure.

2.2 It is important, particularly for larger developments, that you do not consider highways and transportation matters separately from other aspects of a development's design. A coordinated approach to design is vital to:

- help encourage walking, cycling and public transport;
- regulate vehicle speeds (which may be influenced by how drivers regard their surroundings);
- make sure buildings, streets and spaces are designed to reduce risks to personal safety, particularly to pedestrians, cyclists and public-transport users;
- make sure that the design of buildings and where entrances are placed does not encourage people to park in inappropriate on-street locations;
- provide parking areas that are safe, secure and enjoy good natural observation but that do not dominate the appearance of a development;
- deliver high-quality developments that reflect local character and distinctiveness (planning authorities are unlikely to favour developments that lack quality layout and design); and
- take account of external factors, such as pedestrian and cycle routes, public-transport routes and bus-stop locations, or any proposed road improvements that may influence a development's layout and its access to the road network.

2.3 It is important that you approach both us and the planning authority for joint discussions at the earliest opportunity. This approach is strongly recommended in the [Manual for Streets](#). You should also follow the guidance set out in this part of the document so your proposals can be prepared, considered and progressed efficiently. This guidance also tells you what you will normally be required to submit to support your proposals. If you seek our advice prior to submitting a planning application we recommend you use our [pre application advice form \(Appendix O\)](#) to ensure we have the information to assess your proposals efficiently

The 6Cs Design Guide

2.4 We recognise that you may have to carry out more detailed investigations and work at the pre-planning application stage. But where you involve both us and the planning authority early in your planning, agreements can be reached at the pre-application stage. This should reduce the time taken during the planning application, works' technical approval and construction stages.



Section PDP2: Our requirements in general

2.5 We strongly advise you to approach both [us](#) (particularly where a development involves creating a new junction or is likely to result in a change in traffic patterns at an existing junction) and the [planning authority](#) for initial discussions about whether we can accept your proposals in principle. This should help to avoid work on a proposal that cannot be accepted in principle either on highway or planning grounds and planning permission is likely to be refused.

2.6 If your proposal is agreed in principle, you should refer to the relevant parts of this document, including [part 3](#), [part 4](#), and [part 7](#) as you develop it. In some cases, we may need additional supporting details. Table PDP1 indicates which types of development we normally need this for and also gives an indication of the minimum additional details we will usually ask you to provide.

Table PDP1 Normal minimum additional details required to support development proposals^(a)

Land use ^(b)	Use and description of development	No assessment	Transport statement ^(c)	Transport assessment and travel plan ^{(c)(d)(e)}	Concept proposal and supporting information ^{(f)(g)}
GFA = gross floor area					
Food retail (A1)	Retail sale of food goods to the public, including <ul style="list-style-type: none"> • food superstores; • supermarkets; and • convenience food stores. 	GFA up to 250 m ²	GFA between 250 and 800 m ²	GFA over 800 m ²	Up to 800 m ² - not normally required Over 800 m ² - to be agreed with us ^(h)
Non-food retail (A1)	Retail sale of non-food goods to the public and <ul style="list-style-type: none"> • includes 	GFA up to 800 m ²	GFA between 800 and 1500 m ²	GFA over 1500 m ²	Up to 1500 m ² - not normally required

The 6Cs Design Guide

	<p>sandwich bars – sandwiches or other cold food purchased and consumed off the premises; and</p> <ul style="list-style-type: none"> internet cafés. 				Over 1500 m ² - to be agreed with us ^(h)
A2 Financial and professional services	<p>Financial services, including:</p> <ul style="list-style-type: none"> banks; building societies; and bureaux de change <p>Professional services (other than health or medical services) including:</p> <ul style="list-style-type: none"> estate agents; and employment agencies <p>Other services, including:</p> <p>betting shops, principally where services are provided to visiting members of the public.</p>	GFA up to 1000 m ²	GFA between 1000 and 2500 m ²	GFA over 2500 m ²	<p>Up to 2500 m² - not normally required</p> <p>Over 2500 m² - to be agreed with us ^(h)</p>
A3 Restaurants and cafés	Restaurants and cafés selling food to be eaten on the premises. Does not include internet cafés (now A1).	GFA up to 300 m ²	GFA between 300 - 2500 m ²	GFA over 2500 m ²	<p>Up to 2500 m² - not normally required</p> <p>Over 2500 m² - to be agreed with us</p>
A4 Drinking establishments	<p>Includes:</p> <ul style="list-style-type: none"> public houses; wine-bars; or other drinking 	GFA up to 300 m ² Width 9.60	GFA between 300 - 600 m ²	GFA over 600 m ²	<p>Up to 600 m² - not normally required</p> <p>Over 600 m² - to be agreed</p>

The 6Cs Design Guide

	establishments.				with us
A5 Hot food takeaway	For selling hot food for eating on or off the premises.	GFA up to 250 m ²	GFA between 250 - 500 m ²	GFA over 500 m ²	Up to 500 m ² - not normally required Over 500 m ² - to be agreed with us
B1 Business(a)	Offices not included in Class A2 (financial and professional services) (b) Research and development, including: <ul style="list-style-type: none"> • laboratories; and • studios. (c) Light industry.	GFA up to 1500 m ²	GFA between 1500 - 2500 m ²	GFA over 2,500 m ²	Up to 2500 m ² – not normally required Over 2500 m ² – to be agreed with us ^(h)
B2 General industrial	General industry not included in B1). The former ‘special industrial’ use classes (B3 to B7), are now all included in B2.	GFA up to 2500 m ²	GFA between 2500 - 4000 m ²	GFA over 4000 m ²	Up to 2500 m ² - not normally required Over 2500 m ² - to be agreed with us ^(h)
B8 Storage or distribution	Storage or distribution centres, including: <ul style="list-style-type: none"> • wholesale warehouses; • distribution centres; • and repositories. 	GFA up to 3000 m ²	GFA between 3000 - 5000 m ²	GFA over 5000 m ²	Up to 5000 m ² - not normally required Over 5000 m ² - to be agreed with us ^(h)
C1 Hotels	Includes: <ul style="list-style-type: none"> • hotels; • boarding houses; and • guest houses, as long as ‘no significant element of care is provided’.	Up to 75 bedrooms	Between 75 - 100 bedrooms	Over 100 bedrooms	Up to 100 bedrooms - not normally required Over 100 bedrooms - to be agreed with us
C2	Residential	Up to 30	Between	Over 50	Up to 50 beds

The 6Cs Design Guide

Residential institutions - hospitals, nursing homes	accommodation and accommodation providing care to people who need it.	beds	30 - 50 beds	beds	- not normally required Over 50 bed - to be agreed with us
C2 Residential institutions – residential education	Includes: <ul style="list-style-type: none"> • boarding schools; and • training centres. 	Up to 50 students	Between 50 - 150 students	Over 150 students	Up to 50 students - not normally required Over 50 students - to be agreed with us
C2 Residential institutions – institutional hostels	Includes: <ul style="list-style-type: none"> • homeless shelters; • accommodation for people with learning difficulties; and • accommodation for people on probation. 	Up to 250 residents	Between 250 - 400 residents	Over 400 residents	To be agreed with us
C3 Dwelling houses	Includes dwellings for individuals, or families, or not more than six people living together as a single household. Not more than six people living together includes: <ul style="list-style-type: none"> • students or young people sharing a dwelling; • and small group homes for disabled or handicapped people living together in the community. 	Up to 50 dwellings	Between 50 - 80 dwellings	Over 80 dwellings	Normally required for any development exceeding 25 dwellings ⁽¹⁾

The 6Cs Design Guide

<p>D1 Non-residential Institutions</p>	<p>Includes:</p> <p>Medical and health services:</p> <ul style="list-style-type: none"> • clinics and health centres; • crèches; • day nurseries; and • day centres and consulting rooms (not attached to the consultant's or doctor's house) <p>Educational and culture:</p> <ul style="list-style-type: none"> • museums; • public libraries; • art galleries; • exhibition halls; and • non-residential education and training centres <p>Places of worship, religious instruction and church halls.</p>	<p>GFA up to 500 m² ⁽ⁱ⁾</p>	<p>GFA between 500 - 1000 m²</p>	<p>GFA over 1000 m²</p>	<p>To be agreed with us ^{(k)(l)}</p>
<p>D2 Assembly and leisure</p>	<p>Includes:</p> <ul style="list-style-type: none"> • cinemas; • dance and concert halls; • sports halls; • swimming baths; • skating rinks; • gymnasiums; • bingo halls; • casinos; and • other indoor and outdoor sports and leisure uses not involving motorised vehicles or 	<p>GFA up to 500 m²</p>	<p>GFA between 500 - 1500 m²</p>	<p>GFA over 1500 m²</p>	<p>To be agreed with us</p>

The 6Cs Design Guide

	firearms.				
Others	<p>Includes, for example:</p> <ul style="list-style-type: none"> • stadium; • retail warehouse clubs; • amusement arcades; • laundrettes; • petrol filling stations; • taxi businesses; • car and vehicle hire; • businesses selling and displaying motor vehicles; • nightclubs; • theatres; • hostels; • builders' yards; • garden centres; • post offices; • travel and ticket agencies; • hairdressers; • funeral directors; • hire shops; and • dry cleaners. 	To be agreed with us	To be agreed with us	To be agreed with us	To be agreed with us

(a) Based on the national [Guidance on Transport Assessments](#)

(b): In certain circumstance we will need more than the minimum information. For example:

- where there are areas of existing traffic congestion;
- where there are areas of existing on-street parking problems;
- any development that is likely to increase accidents or conflicts among drivers and non-drivers, particularly vulnerable road users such as children, people with disabilities and elderly people;
- where there are areas of poor accessibility to public transport or where the local transport infrastructure is inadequate, for example, the roads are substandard the pedestrian and cyclist facilities are poor;
- any development that generates HGVs which impact on 'sensitive' areas, such as residential areas or an area subject to a weight restriction;
- any development generating significant abnormal loads per year;
- any development located within or adjacent to [Leicestershire and Leicester Air Quality management areas.](#); Please see Derbyshire's and Nottinghamshire's respective websites for information on their Air Quality management areas.

The 6Cs Design Guide

- any development in other 'sensitive' areas, such as where development traffic may affect a school or where there are significant numbers of vulnerable people.
- any development that does not conform with the adopted development plan; and
- any development which proposes 100 or more parking spaces.

(c) Please refer to [paragraph 2.8](#) and to the transport assessment guidelines in [Part 7, appendix C](#) for more details

(d) You will need to prepare a scoping report before a major transport assessment. See the guidelines in [Part 7, appendix C](#).

(e) We are currently preparing detailed guidance on preparing travel plans, but there is some general interim guidance in the transport assessment guidelines in [Part 7, appendix C](#).

(f) Please see [paragraph 2.17](#) onwards for details on concept proposals and supporting information.

(g) You should also refer to [Part 3 for safety audit requirements](#).

(h) We may need a concept proposal for retail, general employment, office and warehousing developments that will be owned or occupied by more than one person or company.

(i) For residential developments over 10 dwellings, you will normally be expected to provide at least 'welcome packs' for residents, providing details of:

- local public transport services and bus travel vouchers;
- provision for cyclists and pedestrians; and
- any nearby services and facilities.

Developments of more than 80 dwellings will normally require a formal travel plan, which includes the information listed above as well as proposals for monitoring, targets and so on. Please see [Part 3, Section DG16 Parking for cycles](#) for details of cycle parking to serve residential developments. (Note: Leicester City, Nottinghamshire and Derbyshire have their own cycle parking standards. Leicester City parking standards, Nottinghamshire County parking standards and [Derbyshire County Council](#).)

(j) In the case of schools and [further and higher education establishments](#), we may need a major transport assessment if pupil or student numbers would be increased by 10% or more.

(k) In the case of schools and [further and higher education establishments](#), we will consider facilities such as a new sports hall or a community facility on a site-by-site basis.

(l) Where a new school is proposed on a site, you should include it in the [concept proposal](#) for the development. We may need a concept proposal for a new stand-alone school depending on its location, proposed size and facilities and traffic conditions in the area.

2.7 For other types of development not included above, or if you need advice about additional supporting information we might require, please [contact us](#).

The 6Cs Design Guide

2.8 For most developments a transport statement (TS) should normally be a relatively short, document, indicating, amongst other things, the steps taken to reduce car travel and promote sustainable modes. A transport assessment (TA) is far more comprehensive. It will normally cover a much wider area and focus on:

- reducing the need to travel, especially by car;
- promoting access to the development by all sustainable modes of travel; and
- dealing with residual car trips and how their impacts can be mitigated (reduced).

2.9 If we require a transport assessment, you should refer to the guidelines on preparing transport assessments in [Part 7, appendix C](#) of this document. You should also discuss and agree the general approach with us before you start.



Section PDP3: The initial preparation stages

- [Assessing surrounding conditions and facilities](#)
- [Establishing key design factors](#)

2.10 The guidance in this section gives advice on how you should prepare your initial development proposals. Once you have done this, you can then prepare your proposals in more detail, confident that the basic principles have been properly established. (Guidance on preparing more detailed proposals is given in [Section PDP4](#)).

2.11 You can follow the guidance in this section as good practice for preparing all development proposals, but it will apply mainly where we require you to submit additional details in support of your proposals

Assessing surrounding conditions and facilities

2.12 Before preparing the development proposal, it is important to establish certain basic information that could influence the design. This includes assessing conditions and facilities surrounding the site. Examples of matters you should consider include:

- the existing standard of the surrounding road network;
- the extent of publicly-maintained highway around the site;
- if there are any proposals to improve the highway that will affect the site;
- the existing traffic situation and any congestion, accident or parking problems;
- if the surrounding road network is subject to either an existing or proposed HGV restriction as part of any lorry control plan;
- if the site is well located in terms of existing or planned pedestrian and cycle routes and how far the walking and cycling distances are from such routes;
- any public footpaths or any other public rights of way such as bridleways, which may be affected by the development;
- any other existing rights to or across the site such as a private access, which may need to be included in the development;

The 6Cs Design Guide

- how well the site is served by an accessible and frequent public-transport service offering a choice of destinations, the location of and routes to any bus stops and any facilities such as shelters;
- if the site is located on a route where there are planned bus-corridor improvements;
- if the site is located in an [air quality management area](#); and
- for new residential developments in particular:
 - how near shops, community or leisure centres, employment areas and so on are located; (the [Manual for Streets](#) sets out that ‘walkable’ neighbourhoods typically have a range of every-day facilities within 10 minutes walking time – up to 800m);
 - the standard of the routes between the development and these facilities, particularly for walking and cycling and how far the walking and cycling distances are from the facilities;
 - the schools children are likely to attend;
 - the standard of routes to the schools, particularly for walking and cycling;
 - any ‘safe routes to school’ proposals; and
 - are the schools able to accommodate more children, for example, what is the existing traffic and parking situation and is there enough classroom capacity. (Contact the relevant [education authority](#) for further details)

Establishing key design factors

2.13 Having collected the necessary basic information, it is then important to establish key design factors. These are likely to help shape the development’s general layout and affect its impact on highways and transportation infrastructure. Such factors include the following.

- Where will the access to the site be located and what type of access is required, for example, priority (give way) junction, roundabout or traffic signals?
- What are the likely main destinations for vehicles, pedestrians and cyclists travelling from or to the site, where are they likely to have come from and what routes are available to them?
- For new residential developments, how safe, direct high-quality routes can best be provided to:
 - nearby shops, community or leisure centres, employment areas and so on, particularly for pedestrians, cyclists and people travelling by bus if any facilities like these proposed on the site; and
 - nearby schools, particularly for walking and cycling. Is a new school proposed on the site?
- Will a new bus service be needed to run through the site, or will existing services running past it need improving?
- How much off-street parking will be needed for a development of this type and in this location?
- For residential developments in particular:
 - what type of parking is proposed, for example, if each property will have its own parking area or if car-parking spaces are to be grouped together to serve several adjacent properties, or if separate, remote parking courts are proposed; and
- Does the layout of the buildings and the roads reflect local character and create a sense of place?

The 6Cs Design Guide

- For employment developments what [use class](#) is proposed. (We will recommend planning conditions to ensure that any assumptions made at this stage are correct when the development is eventually built.)
- Ground contamination and how it will be dealt with.

2.14 You should discuss these initial stages of work jointly with us and the planning authority before proceeding further.

2.15 We will work with the other parties involved to identify and seek agreement on issues, constraints and requirements relating to the site, including those related to highways and transportation, planning and any issues that you might raise.

2.16 It is at this stage that it will be decided whether a transport assessment is required and, if so, which type and with what requirements.

Section PDP4: The concept proposal and supporting information

2.17 Following joint discussions with us and the planning authority, you should then prepare, if needed, a site concept proposal along with any required transport assessment and draft travel plan.

2.18 The purpose of a concept proposal is to bring together all highways and transportation, planning and any other relevant matters to demonstrate how you propose to deliver a safe, accessible and maintainable high-quality development.

2.19 In general, the concept proposal should normally consist of one or more plans along with any supporting information. It should fit together clearly, consistently and logically with any transport assessment and draft travel plan. Any assumptions you make in one document must be reflected in the others. For example, it will not be acceptable for a transport assessment simply to state that occupiers will make a large number of cycle trips without:

- the concept proposal demonstrating how good, safe, cycle access and facilities will be provided in practice; and
- the draft travel plan setting out supporting measures and incentives to encourage cycling (possibly including a target for percentage of cycling trips).

2.20 When you prepare the concept proposal and supporting information, you should refer to the relevant design guidance set out in this document. You should also include 'designing out crime' issues and, where appropriate, meet jointly with us, the Leicestershire Constabulary's Force Architectural Liaison Officer from the relevant police force and the planning authority.

2.21 The specific content of the concept proposal will depend on:

- whether your development proposals are explicitly covered by this design guidance; and
- whether you are intending to submit an outline or detailed planning application for your development.

2.22 For proposals that are explicitly covered, the concept proposal should contain sufficient detail to identify:

The 6Cs Design Guide

(Note: **(O)** = normally required for an **outline application** and **(D)** = normally required for a **detailed application**)

- the general location and layout of the buildings **(O)**;
- for residential developments in particular, any proposed on-site community facilities such as a school, shops, leisure facilities and a children's playground **(O and D)**;
- site accesses and routes through the site, and the role that they are intended to serve. For example, you should show to what extent they are required for main movements of pedestrians, cyclists, buses, cars, heavy goods vehicles or any other vehicles. You should clearly identify and justify any need for segregated, pedestrian, cycle or bus links. Where any shared surface routes are proposed, it is important that you design them for blind or partially-sighted people and that they include an alternative means for visually impaired people to navigate by. As the [Manual for Streets](#) emphasises, we will expect you to consult with relevant representative groups and access officers when preparing your proposals. **(O and D)**;
- basic junction forms **(O and D)**;
- how any existing public or private rights of way will be accommodated **(O and D)**;
- parking arrangements, including clear details of both on-street and off-street provision throughout the development, with housing plot numbers marked on the parking spaces where the spaces are separate from their associated dwelling **(D)**;
- any bus routes and the location and preliminary details of any public transport facilities such as bus stops, lay-bys and, for larger developments, transport interchanges, information and waiting facilities. Pedestrian routes to public transport facilities should also be clearly identified **(O and D)**;
- clear indication of how and where the proposed extents of [adoptable highway](#) will be defined **(D)**;
- details of all materials to be used within areas intended for adoption **(D)**;
- any landscaping proposals, including public open spaces, details of any proposed street furniture, planting and trees, hard landscaping and so on, with any proposals in areas intended for adoption clearly defined **(D)**;
- proposals of materials to be used in other public areas not for adoption, along with clear proposals for long-term maintenance responsibilities **(D)**;
- general drainage arrangements, and particularly any proposals for 'sustainable drainage' systems or separate highway drainage systems **(O and D)**;
- details of how and where utility equipment (for example, gas, water, cable TV) would be accommodated along with confirmation from the relevant [utility companies](#) that the proposals are acceptable to them, including adoption of drainage **(D)**;
- pedestrian, cycle, public transport and other routes for vehicles linking the site to any surrounding developments, and a preliminary indication of any works that might be required to achieve or improve these routes **(D)**;
- the location of any school on the site, the safety of pedestrian and cycle links to it and what measures are proposed to limit the impacts of parents taking their children to and from the school by car **(O and D)**; and
- any other planning requirements **(O and D)**.

2.23 For development proposals that are not explicitly covered by this design guidance - including any new or innovative layouts or for any proposals that include [Home Zones](#), the concept proposal should include the items listed in paragraph 2.22, plus:

The 6Cs Design Guide

Note: **(O)** = normally required for an **outline application** and **(D)** = normally required for a **detailed application**

- examples, if available, of where similar design concepts, features and so on have been successfully used and [adopted](#) by a highway authority **(O and D)**;
- a design statement for the layout, including justifications of assumed speeds and visibility splays. Visibility splays should normally relate to likely vehicle speeds for the particular section of road **(D)**;
- a stage 1 safety audit (and stages 2, 3 and 4 if the development progresses) **(D)**;
- tracking assessments of appropriate vehicle swept paths (likely to include at least a fire engine, refuse wagon and removal van) that identify and take account of likely on-street parking **(D)**;
- more comprehensive details of proposed street furniture, including details of signing and preliminary street-lighting locations **(D)**;
- a disability audit **(D)**;
- details of how bin storage and collection will be dealt with, along with confirmation from the authority responsible for waste collection that it accepts the layout and proposals **(D)**; and
- confirmation from all of the emergency services that the proposals are acceptable to them **(D)**.

2.24 This additional information will help us to consider the development proposals and should help to minimise any problems and delays at later stages.

Section PDP5: Agreement in principle

2.25 After you have prepared the concept proposal and any necessary supporting information, you should hold further joint discussions with us and the planning authorities before submitting a planning application. This is to reach agreement in principle on:



MASTERPLAN
Hobart Fields, Bristol

Reproduced with kind permission of Jelson Ltd
and Derek Lovejoy Partnership

- the site layout, including access;
- areas likely to be [adopted](#) as publicly maintained and those areas to be private;
- any off-site works;
- any financial contributions from you; and
- any travel plan.

2.26 We will take a positive approach to these discussions and work with all parties involved with the proposed development to overcome any problems. However, we will resist development proposals that conflict with our [policies and objectives](#) set out in this document.

The 6Cs Design Guide

2.27 However, assuming that we reach agreement in principle, you should then be in a position to submit a planning application along with all necessary supporting details.

The 6Cs Design Guide

Part 3 Design guidance

- [Section DG1: Introduction](#)
- [Section DG2: Road layouts](#)
- [Section DG3: Home Zones](#)
- [Section DG4: Mixed-use developments](#)
- [Section DG5: Speed control](#)
- [Section DG6: Public transport](#)
- [Section DG7: Pedestrians and cyclists](#)
- [Section DG8: Horse riders](#)
- [Section DG9: Lining, signing and traffic regulation orders](#)
- [Section DG10: Street lighting](#)
- [Section DG11: Utility equipment \(for example, gas, water, cable TV\)](#)
- [Section DG12: Drainage](#)
- [Section DG13: Landscaping](#)
- [Section DG14: Vehicle parking and making provision for service vehicles](#)
- [Section DG15: Parking for motor cycles](#)
- [Section DG16: Parking for cycles](#)
- [Section DG17: Considering parking provision together with transport assessments and travel plans](#)
- [Section DG18: Residential developments served by private drives and areas](#)
- [Section DG19: Employment and commercial developments served by private drives and areas](#)
- [Section DG20: Marking the highway boundary](#)



Section DG1: Introduction

3.1 The guidance contained in this part is intended to help you design development layouts that provide for the safe and free movement of all road users, including cars, lorries, pedestrians, cyclists and public transport. You should select and assemble appropriate design elements to:

- provide road layouts which meet the needs of all users and restrain vehicle dominance;

The 6Cs Design Guide

- create an environment that is safe for all road users and in which people are encouraged to walk, cycle and use public transport and feel safe doing so; and
- help create quality developments in which to live, work and play.

We believe that such an approach, coupled with the flexibility that our guidance allows, already reflects many key themes of the [Manual for Streets 2 \(MfS2\)](#). Also, we have revised certain aspects of 6CsDG to reflect specific MfS2 guidance, particularly with regard to visibility splays. We recognise, however, that further work is required to bring 6CsDG even more closely in to line with the MfS2, in particular with regard to our road design descriptions and guidance. Meanwhile, this will not stop us seeking residential development layouts that recognise that roads have a wider role to play in creating a sense of place and community as opposed to simply having a functional transport role.

3.2 Where this cannot be achieved by development layouts that are explicitly covered by this guidance, we are prepared to be flexible. Subject to [Part 1 paragraph 1.16](#) onwards we will consider layouts that are not covered by the guidance.

3.3 Where development proposals do not align with either the principles or guidance set out in this document it is likely that we will seek to resist those proposals in the interest of the users of the highway network and its primary role in providing safe and effective transport for all. However, if the proposals are significantly out of line with the principles and guidance the Council may recommend a refusal.

Section DG2: Road layouts



- [General geometry and safety audit requirements](#)
- [Emergency accesses](#)
- [The design of residential road layout widths based on tracking](#)
- [Vertical curves](#)
- [Visibility splays](#)
- [Junction design within a development](#)
- [Junction spacing within a development](#)
- [Private-access restrictions](#)
- [Widening on bends](#)
- [Turning heads](#)
- [Materials and construction](#)
- [Adopting new roads](#)

3.4 This section sets out our design guidance for [adoptable roads](#). You can find guidance on Home Zones, public transport, providing for pedestrians and cyclists, and providing for horse riders in sections [DG3](#), [DG6](#), [DG7](#) and [DG8](#), respectively.

(Note: Please see our ['Highways Status Search'](#) page for details of which existing roads are adopted)

The 6Cs Design Guide

3.5 We will continue to encourage developers to create layouts that are to an adoptable standard and that will be offered for adoption. We will not normally adopt developments of five or less dwellings.

3.6 For employment and commercial developments, we will normally expect road layouts serving developments of more than one building and with more than one occupier to meet our adoptable design guidance and be offered for adoption. However, you are encouraged to contact the relevant highway authority with to discuss their adoption requirements for specific proposals. (See [Section DG19](#) for employment and commercial developments served by private drives and areas.)

3.7 You can find advice on how to get your roads adopted under Section 38 of the Highways Act in [Part 5](#) of this document.

General geometry and safety audit requirements

Note: Please see [appendix D](#) for additional information on safety audits.

3.8 External roads and other off-site highway works: These are roads that provide a new link in the road network and serve a more general purpose than simply giving access to a development. Unless they fall outside the definition of a road (street) as set out in [appendix L](#), you should normally design these in line with the appropriate parts of the Manual for Streets 1 and 2 and our [Specification](#) and [standard drawings](#). They should contain measures to control vehicle speeds and to limit the impact on the environment. We will require safety audits in all cases. We may be prepared to consider permitting direct frontage access from properties to such roads providing that they are subject to a 40mph speed limit and 85th percentile speeds are 40mph or less.

3.9 Site access to external roads: Unless the external road falls outside the definition of a road (street) as set out in [appendix L](#), you should normally design these in line with the appropriate parts of the Manual for Streets 1 and 2, and our [Specification](#) and [standard drawings](#). We will not normally accept mini-roundabouts unless they form part of a more comprehensive traffic-calming scheme that is either required to minimise the development's impacts or that has previously been identified. A mini-roundabout will not be acceptable where it is proposed simply because the necessary visibility for a [priority junction](#) cannot be achieved. We may be prepared to consider permitting direct frontage access from properties to the external road providing that they are subject to a 40mph speed limit and 85th percentile speeds are 40mph or less.

3.10 Site-specific requirements will depend on a number of factors including:

- location;
- safety considerations;
- traffic, pedestrian and cycle flows; and
- public transport requirements.

You should establish and agree our requirements with us in the early stages of preparing your development proposals. We will require safety audits in all cases.

3.11 Internal development roads: These are roads that serve only the development. You should normally design them in line with the sections below, which cover residential developments around 1000 dwellings and employment and commercial developments, and

The 6Cs Design Guide

our [Specification](#) and [standard drawings](#). We will consider the design of development roads for sites of over around 1000 dwellings, or which are otherwise not covered by the following guidance, on a site-by-site basis.

3.12 We will not normally require safety audits of internal development roads unless:

- the layout contains features which are not explicitly covered by this document; or
- the proposal is for or contains a Home Zone.

Figure DG1 Examples of shared surfaces



3.13 Table DG1 gives general geometry for internal residential roads. In general terms, a residential access road is a conventional cross-section road with separate provision for vehicles and pedestrians. On a residential access way users share a common surface.

The 6Cs Design Guide

Table DG1: General geometry of residential roads (internal)

	Major Residential access road	Residential access road	Residential access way
Type of use	Mainly vehicles (bus access likely)	Mainly vehicles	Mainly pedestrians and cyclists. Not normally acceptable for use on a bus route
Normal dwelling limits	1000 Normally no more than 400 from a single point of access ^(a)	400 Normally no more than 150 from a single point of access ^(a)	50 Normally no more than 25 from a single point of access ^(a)
Access to schools ^(b)	Yes	Yes, but not as a cul-de-sac	No
85th %ile design speed	20mph	20 mph	15mph
Shared surface	No	No	Yes ^(c)
Widths for two-way traffic: Note: Where a road is to be narrowed, to help control vehicle speeds, for example, the minimum <i>carriageway</i> width (kerb to kerb) = 3.7m. Minimum <i>lane</i> width at a restriction, such as pedestrian refuge in the middle of the road = 3.2m.	Carriageway width; ^{(d) (f)} 6.75m	Carriageway width: ^{(d) (f)} 4.8m up to 50 dwellings 5.5m 50 to 400 dwellings Except on a bus route where the carriageway should be a minimum of 6m wide (subject to tracking assessment) or on a road serving a school where the carriageway should be 6.75m wide in all cases.	Overall corridor width; ^{(e) (f)} 7.5m
Centre-line radius	Defined by tracking ^(g)	Defined by tracking ^(g)	Defined by tracking ^(g)
Crossfall	1:40	1:40	1:40
Longitudinal gradient	Flexible surfacing minimum: 1:100 Block surfacing minimum: 1:80 In all	Flexible surfacing minimum: 1:100 Block surfacing minimum: 1:80 In all cases maximum:	Flexible surfacing minimum: 1:100 Block surfacing minimum: 1:80 In all cases

The 6Cs Design Guide

	cases: 1:20 ^(h) In all cases at junctions: not to exceed 1:30 for first 10m of the side road	1:20 ^(h) In all cases, at junctions: not to exceed 1:30 for first 10m of the side road	maximum: 1:20 ^(h) In all cases, at junctions: not to exceed 1:30 for first 10m of the road
Vertical curves. See paragraph 3.25	See paragraph 3.25	See paragraph 3.25	See paragraph 3.25
Visibility distance at junctions, bends and vertical crests	25m	25m ⁽ⁱ⁾	17m ⁽ⁱ⁾
Verges		Grassed verges minimum 1m wide, minimum area 10sqm. Hard paving otherwise	Grassed verges minimum 1m wide, minimum area 10sqm. Hard paving otherwise
Steps		Not normally acceptable in areas to be adopted as public highway unless a suitable alternative ramp is provided for those unable to climb steps.	Not normally acceptable in areas to be adopted as public highway unless a suitable alternative ramp is provided for those unable to climb steps.

(a) We will consider developments in excess of the single-access limits on a site-by-site basis. See also [paragraph 3.15](#).

(b) Care must be taken in the design of roads serving schools. Parking in the vicinity of schools as children are dropped-off or collected, is a serious safety hazard and can cause traffic congestion.

For new residential developments, any need for a new school on the site must be established early on (see [Part 2 para 2.10](#) onward). The school should be located to maximise opportunities:

- for children to walk and cycle to school;
- to provide safe routes to school; and
- to minimise the risk of on-street parking problems.

All of this will need to be considered as part of the transport assessment for the development and a school travel plan will be required.

The 6Cs Design Guide

Where a proposed development requires the expansion of an existing school, (that is the construction of one or more new classrooms) the traffic impacts of the expansion must be considered early on and as part of any transport assessment required for the development. Measures will normally be required to provide 'safe routes to school' and minimise the risk of causing or making worse on-street parking problems.

(c) The [Manual for Streets](#) suggests that shared surfaces work well in short lengths or where they form cul-de-sacs, where traffic is less than 100 vehicles per hour, and where parking is controlled. Care must be taken in the design of shared-surface layouts to ensure that the development's whole design, including building type and layout, use of street furniture and so on, conveys to users the nature of the area. Motor vehicles should not dominate and the layout should not simply appear to be a road without footways. Vertical traffic calming measures are not acceptable on shared surfaces.

It is also important that any shared surface is designed for blind or partially sighted people and that they include an alternative means for visually impaired people to navigate by. As the [Manual for Streets](#) documents emphasises, we will expect you to consult with relevant representative groups and access officers in designing your proposals.

The type of surfacing materials will normally be a secondary feature in defining the nature of the area. It will not normally be acceptable simply to use a different material to convey the nature of an area to users. We will consider the surfacing material you propose for any shared-surface area with regard to the development's overall design, including proposed housing layouts.

(d) The carriageway width does not include any footways, verges and so on. We may be prepared to accept a narrower, single *carriageway* width of 3.7m between kerbs over short lengths as a speed-control feature. The minimum *lane* width of 3.2m applies only where there are limited restrictions, for example where a pedestrian refuge is provided in the middle of the road.

(e) The corridor width is the minimum space required to accommodate all likely road users and utility equipment (for example, gas, water, cable TV). It does not include any additional space for outward-opening windows, drainage downpipes and so on where dwellings front direct onto the highway. You should define vehicle paths within the corridor by a tracking assessment. See [paragraph 3.21](#).

(f) Where a proposed building fronts directly on to the highway, that is, it has no front garden, it should be set back at least 0.5m behind the proposed highway boundary to allow for opening of windows, drainage downpipes, overhanging eaves and so on .

(g) See [paragraph 3.21](#).

(h) Taking into account the needs of people with impaired mobility, we may be prepared to consider a relaxation to on sites with particularly difficult topography. However, relaxations should not form the starting point of longitudinal design. The financial cost of cut/fill is not a material consideration when assessing the ability to achieve gradients to aid walking/cycling.

(i) See also paragraphs [3.26](#) and [3.27](#).

3.14 Table DG2 gives the general geometry for internal employment and commercial roads. In general terms, both major industrial access roads and the minor industrial roads are

The 6Cs Design Guide

conventional cross-section roads with separated provision for vehicles and pedestrians, but their designs vary depending on likely levels of heavy-goods vehicles (HGVs).

Table DG2: General geometry of employment and commercial roads ^(a)

	Type of internal development road	Type of internal development road
	Major industrial access road	Minor industrial access road
Planning use class	B2 to B8 ^(c)	B1 ^{(b) (c)}
Development limit	Normally no more than 8 hectares for a single point of access ^(d)	Normally no more than 8 hectares for a single point of access ^(d)
85th %ile design speed	30mph	25mph
Shared surface	No	No
Widths for two-way traffic	Carriageway width: 7.3m	Carriageway width: 6m for offices 6.75m for other B1 uses
Centre-line radius	55m minimum	Defined by tracking ^(e)
Crossfall	1:40	1:40
Longitudinal gradient	Minimum: 1:100 Maximum: 1:20 ^(f) At junctions: not to exceed 1:30 for first 10m of the side road	Minimum: 1:100 Maximum: 1:20 ^(f) At junctions: not to exceed 1:30 for first 10m of the side road
Vertical curves	See paragraph 3.25	See paragraph 3.25
Visibility distance at junctions, bends and vertical crests	70m ^(g)	45m ^(g)
Verges	Grassed verges minimum 1m wide, minimum area 10sqm. Hard paving otherwise.	Grassed verges minimum 1m wide, minimum area 10sqm. Hard paving otherwise.
Steps	Not normally acceptable in areas to be adopted as public highway unless a suitable alternative ramp is provided for those unable to climb steps.	Not normally acceptable in areas to be adopted as public highway unless a suitable alternative ramp is provided for those unable to climb steps.

(a) Other [use classes](#), for example shopping and leisure, will be considered on a site-by-site basis and depending on the likely numbers of HGVs.

(b) We will recommend planning conditions to restrict change of use from B1 to B2 - B8 developments unless the roads provided are to major industrial road standard – including construction specification – or the development layout provides for their future improvement at a developer's expense.

(c) Where a B1 development is large enough to generate significant numbers of HGVs, we may require a major industrial road. However, where a B2 - B8 development is small

The 6Cs Design Guide

enough to generate only a small number of HGVs, for example business starter units, we may be prepared to accept a minor industrial access road instead.

(d) We will consider developments in excess of the single access limits on a site-by-site basis. See also [paragraph 3.15](#).

(e) See [paragraph 3.21](#).

(f) Taking into account the needs of people with impaired mobility, we may be prepared to consider a relaxation to 1:12 on sites with particularly difficult topography.

(g) See also paragraphs [3.26](#) and [3.27](#).



Well- connected street and Emergency accesses

3.15 New residential streets should be designed to form part of a well-connected street network. Well-connected street networks have significant advantages:

- A shorter route can be used to cover a given area;
- reversing may be avoided altogether;
- they also minimise land-take by avoiding the need for wasteful turning areas at the ends of cul-de-sacs;
- encourage more people to walk and cycle to local destinations, improving their health while reducing motor traffic, energy use and pollution;
- more people on the streets leads to improved personal security and road safety- research shows that the presence of pedestrians on streets causes drivers to travel more slowly;
- for utility companies - service provision and alternative service routes;
- for highway and utility maintenance operations as traffic can be routed around a point closure if it is necessary to excavate the carriageway for maintenance.

3.16 As such developments will usually need at least two access points to the highway network. The number of external connections that a development provides depends on the nature of its surroundings. These access points should be to [adoptable](#) standards and available for general public use.



The 6Cs Design Guide

3.17 However, cul-de-sacs may provide the best solution for developing awkward sites where the site is linear in nature, has difficult topography, boundary or other constraints and where through routes are not practical.

3.18 We will not normally accept emergency accesses because of:

- enforcement problems arising from their misuse;
- difficulties encountered by the emergency services;
- maintenance issues and vandalism of access-control equipment; and
- general crime and anti-social behaviour problems

3.19 However, where there are valid reasons why this cannot be achieved, and where the development proposal is otherwise acceptable to us, we may be prepared to consider an emergency access as long as:

- highway safety is not compromised and the access is not likely be a source of crime or anti-social behaviour problems;
- there are appropriate means of controlling its use;
- you have fully consulted the emergency services and the proposals are acceptable to them (your consultations with the police should include both traffic management and the Police Architectural Liaison Officer);
- the access is designed to accommodate safely all vehicles likely to use it; and
- long-term maintenance responsibilities are clearly defined and secured.

3.20 Where suitable access arrangements cannot be achieved, we may refuse to adopt the development roads.

The design of residential road layout widths based on tracking

3.21 Tracking is providing the required width for vehicle movement within the overall width of the road. It can also be used to establish appropriate bend radii. Instead of taking the highway engineering requirements as the starting point for layout design, you can consider the arrangement of the buildings and the boundaries of the development first. You can lay out buildings to suit a particular form, with kerb lines helping to define and emphasise spaces. The width between kerbs can vary. (You can find further information on how to use tracking in the [‘Manual for Streets’](#) documents, published by the Department for Transport [\(an example\)](#). Where tracking of large vehicles results in the use of the whole width of the carriageway to make manoeuvres on narrow roads it is important to ensure that forward visibility to bends is provided in accordance with Part 3 Table DG4 to enable this to be achieved safely. There should be no recourse to reducing the width of roads such that it is necessary for the drivers of the private motor car to make use of the whole width of the carriageway to make similar manoeuvres”

3.22 You will then need to check the layout, including widths and bend radii, to make sure that the various types of vehicles you expect to visit and use the road layout can manoeuvre. This is normally likely to include a refuse lorry, fire tender and pantechnicon (for example, a removal lorry) and a bus if the development will be served by public transport. You should do this using a computer software package to generate swept paths for particular types of vehicles and to superimpose them onto layout drawings.

The 6Cs Design Guide

3.23 The tracking assessments will need to take account of any planned or likely on-street parking (see Section DG14, in particular [paragraph 3.188](#) onwards).

3.24 You should check the proposed layout and get our agreement before submitting a planning application. The layout will also need to satisfy other relevant design guidance for the road type to achieve the design speed and to create a safe environment for all road users, including pedestrians and cyclists.

Vertical curves

3.25 Where changes in gradient occur, vertical curves will be required at sags and crests. Except where indicated in the notes to Table DG3, curve lengths should normally be either:

- the sum $K \times A$, where K is given in Table DG3 and A is the algebraic difference of the gradients expressed as a percentage; or
- the 'minimum length for appearance' given in Table DG3;

whichever is higher.

Example calculation of length of vertical curve

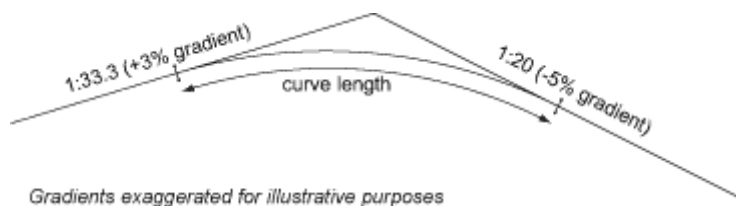

For 20mph design speed $k = 3$ (from Table DG3)

Algebraic difference of gradients expressed as a percentage = $+3.0 - (-5.0)$
= 8.0

Curve length = 3×8
= 24

(minimum length for appearance = 20m (from table DG3))

The 6Cs Design Guide

Table DG3: Vertical curves for all internal roads ^{(a) (b)}

85th %ile design speed (mph)	Minimum length of vertical curve ^(c)	Minimum length of vertical curve ^(c)
	K	Minimum length for appearance (metres) ^(d)
30 ^(e)	6.5	30
25 ^(e)	4	25
20	3	20
15	2	20

(a) You should hold early discussions with us for large, flat sites to ensure that the vertical alignment is acceptable. In some cases, it may be necessary to provide combined kerb and drainage units to ensure both an acceptable alignment and drainage of the highway.

(b) For crests, it may be necessary to increase the length of vertical curve derived in order to achieve the visibility distance as set out in table DG4.

(c) We may accept shorter curve lengths where there are exceptional difficulties in achieving the length normally required

(d) To avoid stretches of road where water gathers, do not apply the minimum length where A is less than five on any sag curve that results in a low point on the road.

(e) Speeds on new residential development roads should normally be restricted to 20mph or less.

Visibility splays

3.26 Table DG4 sets out visibility splays normally required for junctions, bends and at vertical crests. The starting point when calculating visibility splays should be the Manual for Streets, unless the external road falls outside the definition of a street as set out in Appendix L. Otherwise you should use the calculation in the Design Manual for Road and Bridges. For proposed internal development roads, you should normally base visibility splay on an assessment of likely 85th% ile vehicle speeds. For existing roads, you should base it on measured vehicle speeds. We will normally require you to carry out radar surveys to measure existing speeds and establish the 85th% ile.

3.27 While taking into account the design speeds in Tables DG1 and DG2, we will assess visibility requirements based on likely vehicle speeds within a proposed development. Where we are satisfied that speeds are, in practice, likely to be lower than the design speeds, we will normally be prepared to consider correspondingly shorter splays. The

The 6Cs Design Guide

reverse is also true - if speeds are likely to be higher, the splays will need to be correspondingly greater in length.

Table DG4: Visibility splays

Assessed likely vehicle 85th %ile vehicle speed (mph)	Measured 85th %ile vehicle speed (mph)	Visibility distance at junctions, bends and vertical crests (m) ^(a)	
		Light vehicles	HGV and buses ^(e)
15	11 to 15	17 ^(c)	19 ^(c)
20	16 to 20	25 ^(c)	27 ^(c)
Speeds on new residential development roads should normally be controlled to 20mph or less ^(b)	21 to 25	33 ^(c)	36 ^(c)
Speeds on new residential development roads should normally be controlled to 20mph or less ^(b)	26 to 30	43 ^(c)	47 ^(c)
Speeds on new residential development roads should normally be controlled to 20mph or less ^(b)	31 to 35	54 ^(c)	59 ^(c)
Speeds on new residential development roads should normally be controlled to 20mph or less ^(b)	36 to 40	65 ^(d)	73 ^(c)
Speeds on new residential development roads should normally be controlled to 20mph or less ^(b)	41 to 44	120 ^(d)	120 ^(d)
Speeds on new residential development roads should normally be controlled to 20mph or less ^(b)	45 to 53	160 ^(d)	160 ^(d)
Speeds on new residential development roads should normally be controlled to 20mph or less ^(b)	54 to 62	215 ^(d)	215 ^(d)
Speeds on new residential development roads should normally be controlled to 20mph or less ^(b)	63 to 75	295 ^(d)	295 ^(d)

(a) See Figure DG2 below for guidance on constructing splays.

The 6Cs Design Guide

- (b) Where speed is assessed to be over 20mph, splay provision will normally be based on the appropriate 'measured 85th %ile vehicle speed' distance.
- (c) Based on the [Manual for Streets](#), documents 'adjusted for bonnet length' distances.
- (d) Based on [Design Manual for Roads and Bridges](#).
- (e) Use figures for HGV and buses if these vehicles make up more than 5% of actual or predicted total traffic flow.
- (f) We will accept calculated values for actual agreed 85th percentile speeds

[up to top](#) | [back to contents page](#)

Figure DG2 Construction of visibility splays

(For all horizontal visibility splays, where a footway, cycle way or similar is provided, the rear of the footway and so on should coincide with (match) the rear edge of the visibility splay.)

A more accurate assessment of a visibility splay is made by measuring to the nearside edge of the vehicle track. The measurement is taken from the point where this line intersects the centerline of the minor arm unless there is a splitter island in the minor arm.

Figure DG2a Junctions

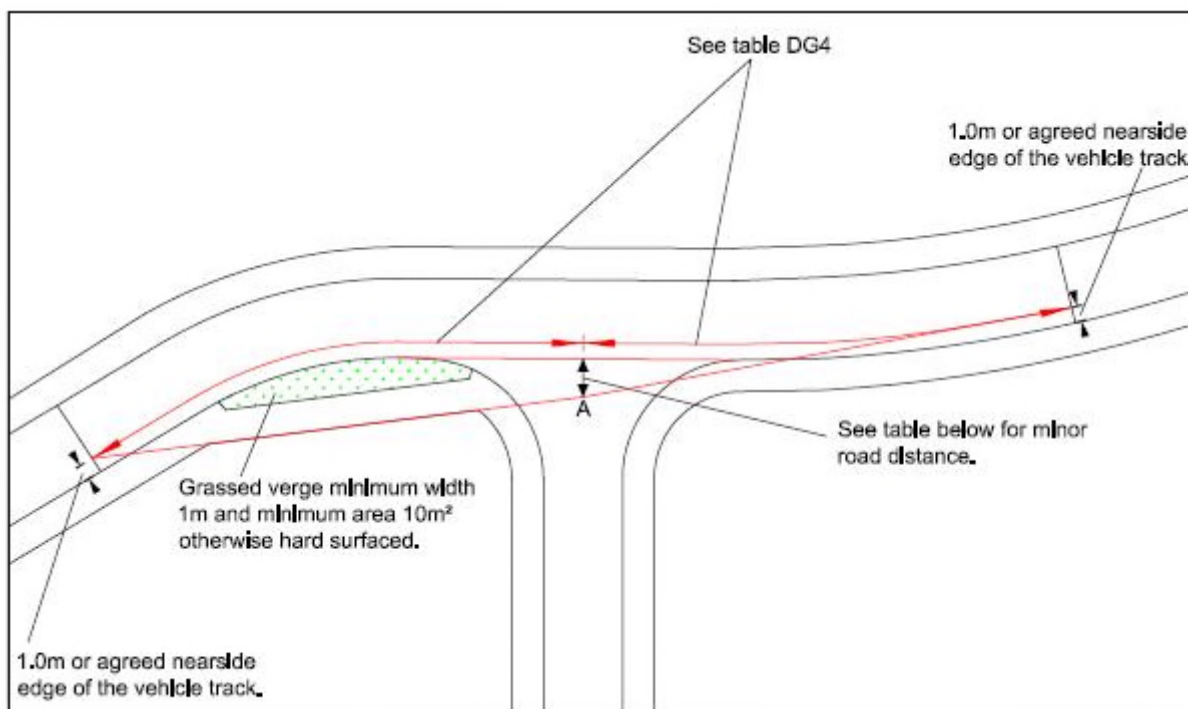

The 6Cs Design Guide

Main road ————— Side road	Road (street) as defined at Appendix L	Residential access road	Residential access way	Major industrial access road	Minor industrial access road
Residential access road	2.4m	2.4m	2.4m		
Residential access way	2.4m	2.4m	2.4m		
Major industrial road	4.5m			4.5m	4.5m
Minor industrial road	4.5m - 2.4m*			4.5m - 2.4m*	4.5m - 2.4m*

* Set back will depend on scale and nature of proposed development

Figure DG2b Bends

Note: For all road types **within** a development, visibility (at junctions, bends or crests) in the vertical plane should normally be measured from a drivers eye-height of no less than 1.05m above the road surface to a point no less than 0.6m above the road surface. This is as set out in the [Manual for Streets](#) documents. On roads **outside** of the development, for example at the site access, the visibility should normally be measured from an eye-height of not less than 1.05m to a point not less than 0.26m, in line with the [Design Manual for Roads and Bridges](#). However, if they fall within the definition of a road (street) as defined at [appendix L](#), visibility can normally be measured as if the road lies **within** a development

The 6Cs Design Guide

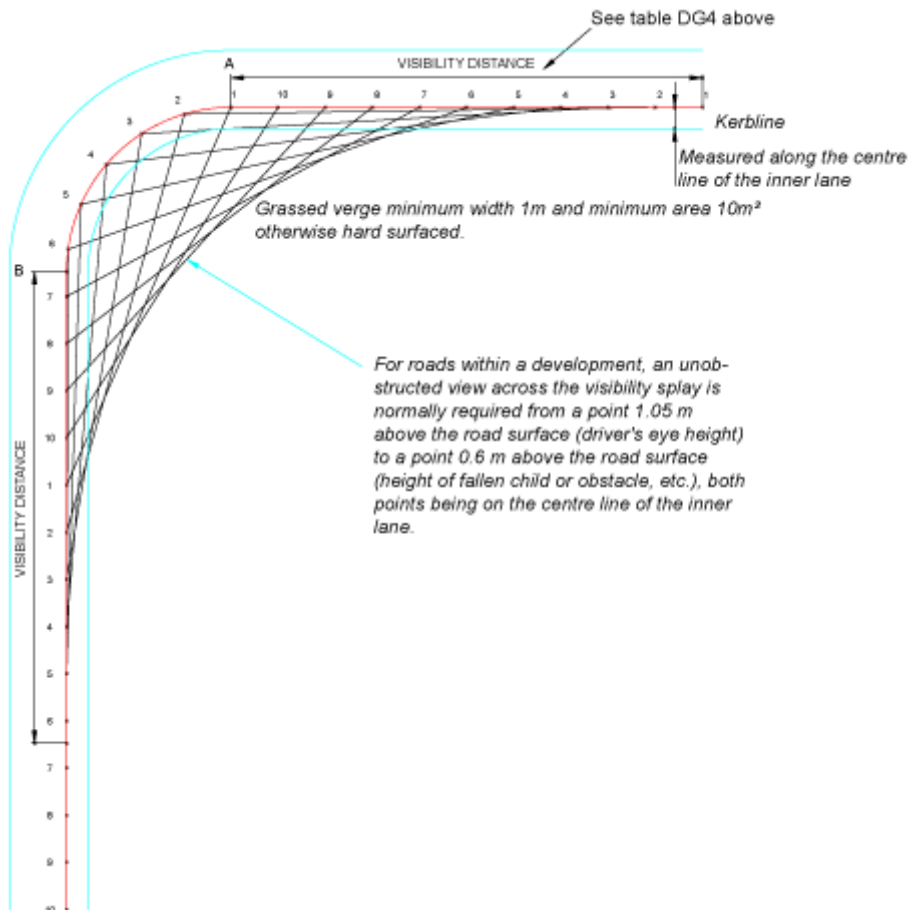
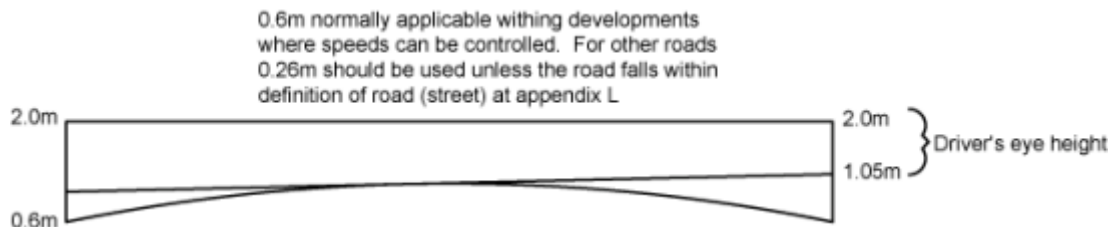

Figure DG2c Crests in road (brow of hill)



Junction design within a development

3.28 Basic junction forms should be determined at the [concept layout \(masterplanning\) stage](#) with the more detailed proposals developed as the development proposal evolves.

Table DG5 and the accompanying illustrations highlight broad junction types and the corner radii that should normally be provided within developments.

The 6Cs Design Guide

Table DG5: Broad junction types and corner radii within developments ^(a) ^(b)

Nodal form	T	Y	Cross / Staggered	Multi armed	Square	Circus	Crescent
Regular							
Irregular							

The above diagram is based upon Figure 7.9 of the Manual for Streets documents. The Manual for Streets is copyright of the Department for Transport and Department of Communities and Local Government.

Development type ^(d)	Road type ^(e)	Corner radii (m) ^(f) ^(g) ^(h)
Residential	Entry to a Residential access way or road or junction between access ways and roads	6m ^(b)
Industrial and commercial		
Use class B1 offices	Entry to Minor industrial access road or junction between access roads	6m
Other B1 uses	Entry to Minor industrial access road or junction between access roads	10m
Use classes B2 to B8	Entry to Major industrial access road or between access roads	

The 6Cs Design Guide

- (a) See [paragraph 3.9](#) for site access junctions.
- (b) A lower radii may be acceptable if suitable tracking is carried out
- (c) See [Section DG9](#) for details on lining and signing.
- (d) Development types not listed will be considered on a site-by-site basis.
- (e) For further details, please [paragraph 3.11](#) onwards.
- (f) Radii based on road widths set out in [Table DG1](#) and [Table DG2](#), assuming that roads meet at an angle of 90 degrees. For other circumstances (including any proposals for tighter radii), you will be required to provide computer tracking assessments ([see paragraph 3.21](#)) of your proposed layout.
- (g) Other factors will also be taken into account in considering your junction proposals. This includes the likelihood of on-street parking problems in the vicinity of the junction and whether or not the roads are likely to form part of a bus route.
- (h) Where a corner radius is less than 7.5m, footway strengthening will be needed. Please see [Part 4 paragraph 4.97](#).

Junction spacing within a development

3.29 You should normally avoid priority-controlled ('Give way') crossroads. When a crossroads cannot be avoided, you should normally provide an appropriate form of control such as a roundabout. Mini-roundabouts will not normally be acceptable to provide access to a development unless they form part of a more comprehensive traffic-calming scheme that is either required to reduce the development's impacts or that has previously been identified.)

3.30 You should space road junctions on the same side of a road so that a vehicle waiting to enter the main road at one does not interfere with visibility for a vehicle waiting at another.

The 6Cs Design Guide

Figure DG3 Junction spacing

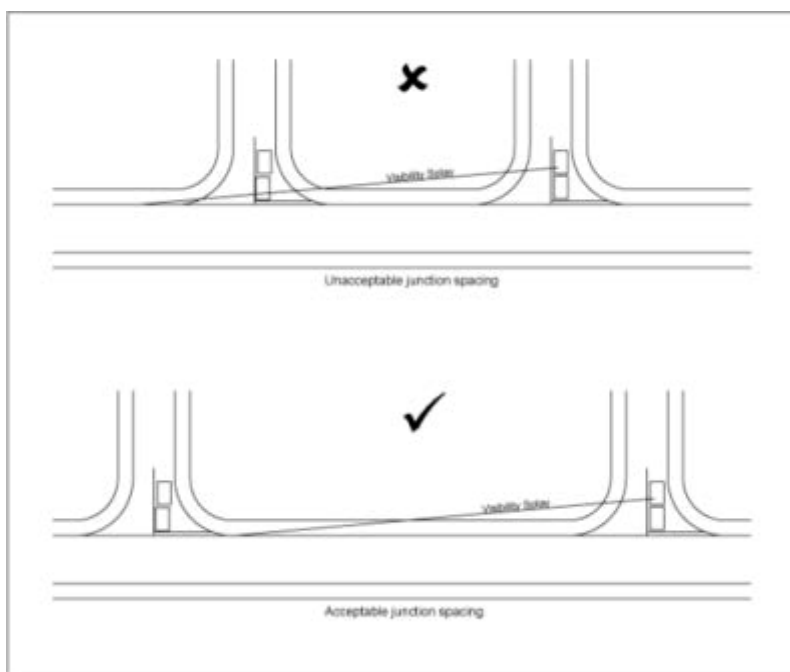

Private-access restrictions

3.31 There should normally be no accesses for vehicles:

- on to the corners (radii) of the junction;
- at bus stops or lay-bys;
- close to a pedestrian or cycle refuge;
- close to a traffic-calming feature (accesses should not be sited on the ramp of a road hump or speed table due to the risk of a vehicle grounding as it manoeuvres into or out of the access); and
- close to street furniture.

3.32 Elsewhere, we will normally accept accesses as long as they meet safety considerations and comply with the guidance on the design of private accesses and areas set out in [Section DG18](#) and [Section DG19](#).

Widening on bends

3.33 On residential roads serving more than 25 dwellings, carriageways should normally be widened at bends that curve through more than 10 degrees.

Table DG6: Residential roads – widening on bends

Centre-line radius (m)	20	30	40	50	60	80
Minimum widening	0.60	0.40	0.35	0.25	0.20	0.15

The 6Cs Design Guide

3.34 Bends should normally be widened in industrial and commercial developments.

Table DG7: Industrial and commercial roads – widening on bends

Centre line radius (m)	55 to 74	75 to 89	90 to 150
Minimum widening	1.2	0.7	0.6

3.35 For any proposals not conforming to the figures in the above table, you will need to produce computerised vehicle-path assessments to show that the proposed layout can accommodate appropriate vehicles without danger to other road users, including pedestrians and cyclists.

Turning heads

3.36 A turning head should normally be provided at the end of all cul-de-sacs or wherever vehicles would otherwise have to reverse over long distances – normally anything over 25m, in line with [BS5906, 1980](#). You should also provide turning heads where turning vehicles might damage adjacent verges or footways. Figure DG4 shows minimum turning dimensions and areas. It may be necessary to provide tracking details for turning heads to ensure that a specified Waste/Recycling vehicle can negotiate a turning area satisfactorily.

For further information, including on vehicle specification, please contact the relevant Authority.

3.37 You should give careful consideration to the design of the development surrounding the turning head to make sure that its use is not reduced by on-street parking. Where on-street parking is likely to cause problems, we will normally expect you to provide measures to control it (see Section DG14, in particular [paragraphs 3.192](#) onwards).

3.38 We will consider larger areas, such as residential squares, which provide the minimum turning dimensions as long as their use as a turning head would not be affected by on-street parking. You would also be required to provide clear details of who is responsible for maintenance. Where it is intended that we [adopt](#) any extra areas over the normal minimum, we may require you to pay [commuted sums](#) for future maintenance (see [Part 4 Section MC18](#)).

The 6Cs Design Guide

Figure DG4 Turning heads

Figure DG4a Example of a turning head within a 'square'



This is an example of a highway square which forms the end of a road and a turning area. The area must be proven through tracking to allow turning. The edge of any turning area need not be demarcated on site.

The 6Cs Design Guide

Figure DG4b Turning heads for use on residential access roads and minor industrial access roads serving offices

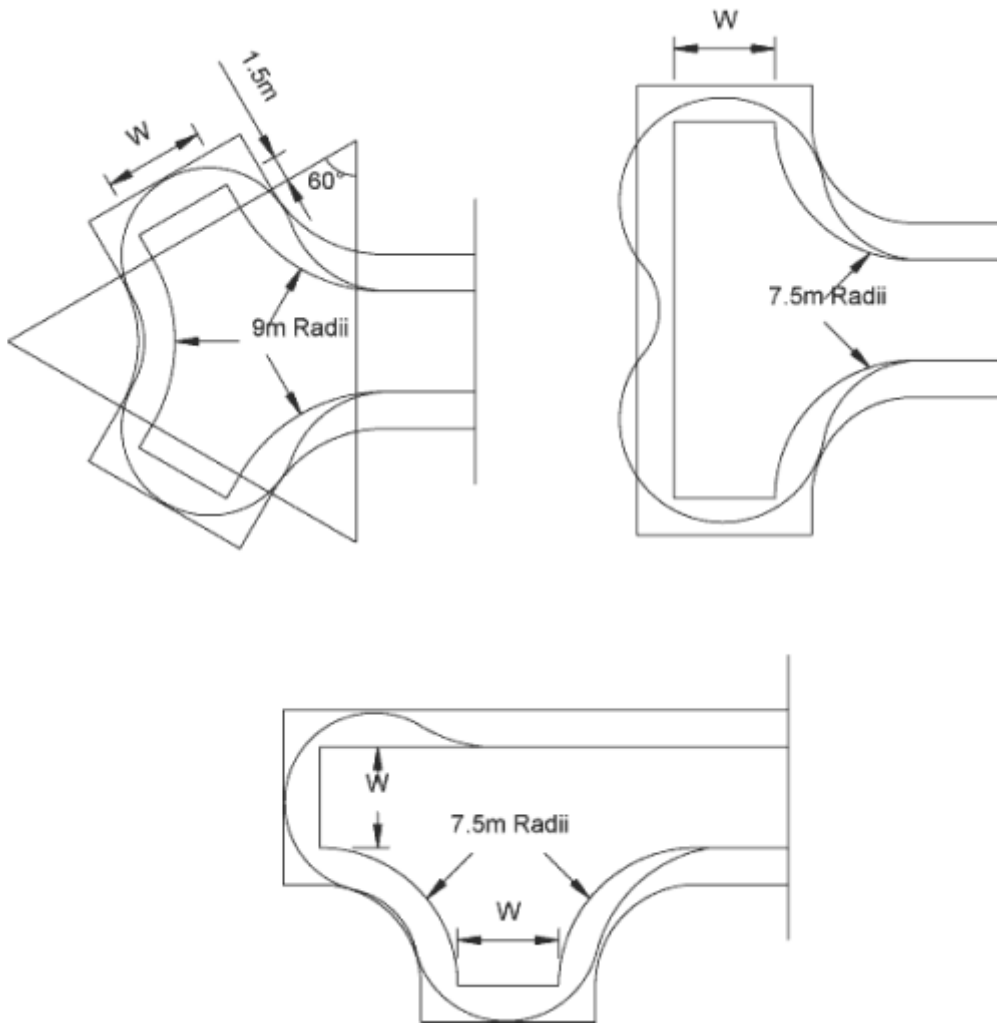

$W = 4.8\text{m}$ up to 50 dwellings

$W = 5.5\text{m}$ from 50 - 400 dwellings

$W = 6\text{m}$ for B1 [use class](#) office developments

The 6Cs Design Guide

Figure DG4c Turning heads for use on industrial/commercial estate roads

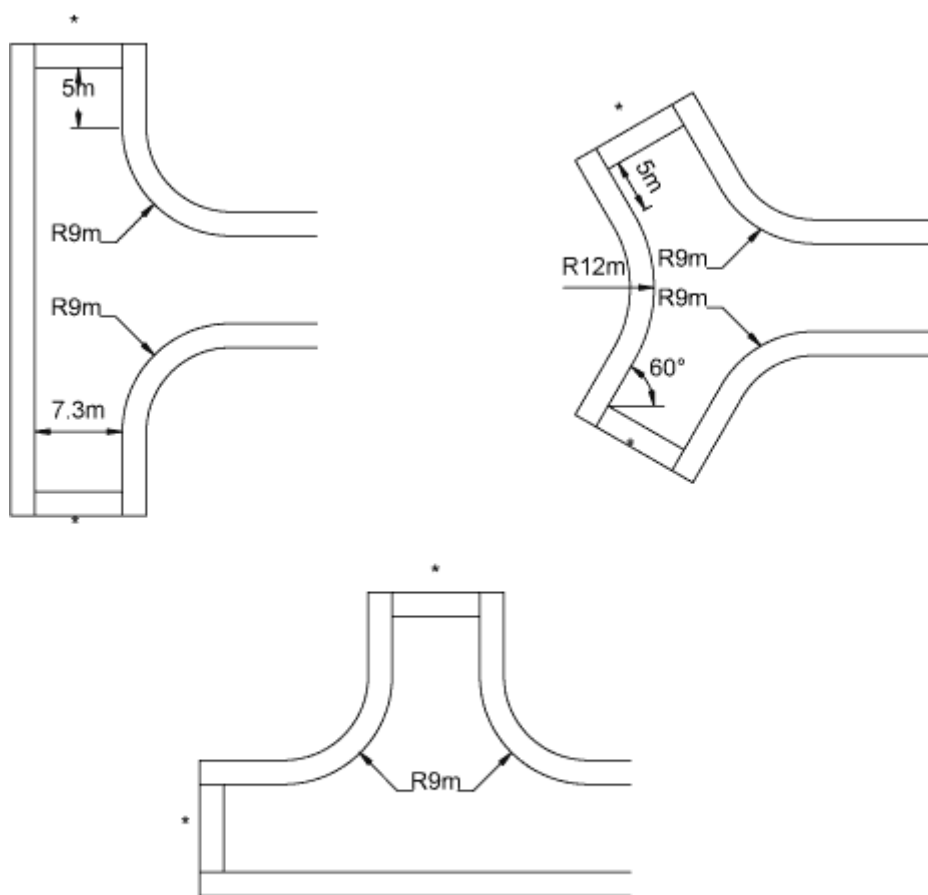

* Depending upon the type of vehicles likely to use the road, a footway may be required around the end of the turning head.

Materials and construction

3.39 Please refer to [Part 4](#). The standard construction requirements and materials set-out in this Part are based on national standards and advice used in general for constructing and maintaining highways throughout Leicestershire, Derbyshire and Nottinghamshire. They should normally be applied to **all** highway works and have been chosen to make sure the highways function safely and to make sure that they can be maintained in the most cost-effective way. To achieve these ends, we have considered the principles of quality, durability, maintainability and sustainability.

However, it is recognised that each Authority has regional variants in its palette of construction materials that should be used in such places as City Centres/ Conservation areas. Reference should always be made to the relevant Authorities website for local advice on construction materials. For example, in Nottingham City please refer to the Nottingham City Centre Streetscape Design Manual.

Adopting new roads

3.40 We will normally adopt a new road where:

The 6Cs Design Guide

- it serves more than five dwellings or serves a multiple building and multiple-occupation industrial or commercial development;
- all highway works have been designed and completed to our satisfaction;
- an agreement under S104 of the Water Industry Act has been signed with the [relevant water company](#) for the road's drainage to be adopted, or alternatively we are satisfied to adopt the drainage; and
- the development served by the road is acceptable in all other highways and transportation respects, for example in terms of parking provision.

3.41 Please see [Part 5](#) for details of adopting roads under a Section 38 agreement of the Highways Act. In this Part, [Section DG18](#) gives guidance on the layout of private roads and areas in residential developments and [Section DG19](#) gives guidance on the layout of industrial and commercial developments.

3.42 In some cases, [commuted sums](#) may be payable. For example this will normally be for:

- additional areas exceeding usual highway design standards and which are not required for the safe functioning of the highway;
- materials outside our usual Specification;
- non-usual or additional street furniture;
- landscaping within the proposed highway, including trees; and
- sustainable drainage systems (SUDS), for example, flow-attenuation devices, swales and storage areas for highway drainage.

Note:

Where you are proposing SUDS, you must hold discussions with all relevant parties at an early stage (and certainly before any planning application) to agree ownership and responsibility for the facility.

This is not an exhaustive list, and there are other occasions described throughout this document where we require the payment of commuted sums, for example vertical traffic calming.

3.43 Please refer to [Part 4](#) for further details of where commuted sums will normally be payable and for details of how they are calculated.

The 6Cs Design Guide



Section DG3: Home Zones

- [Principles](#)
- [The legal framework](#)
- [General design considerations](#)
- [Adopting new Home Zones](#)

Principles

3.44 '[Home Zone](#)' is the term used for a street where people and vehicles share the whole of the road space safely and equally.

3.45 Home Zones are based on a change in the way that people regard the street. Motorists should feel that they have left the normal highway and have entered an area where they can expect to find people who are using the whole of the street. Simply, Home Zones should make motorists feel they are guests in a pedestrian environment, and they should drive accordingly.

3.46 Home Zones may consist of shared surfaces, indirect traffic routes, areas of planting and features such as seating to encourage people to use the street. Entry gateways and signing will be needed to mark the limits of the area.

3.47 Home Zones are a relatively new idea in the UK, and some of the legal regulations to introduce them have only recently been put in place.

The legal framework

3.48 Section 268 of the [Transport Act 2000](#) provides the legal basis for establishing Home Zones in England and Wales. It permits local traffic authorities (us, in this case) in England and Wales to designate any street or streets as a Home Zone. However, this in itself does not change the legal use of the highway. This can only be done by local authorities making use orders and speed orders for designated Home Zones.

3.49 The Secretary of State has recently made the necessary regulations under the Transport Act setting out the procedures for designating Home Zones and making use orders and speed orders. A use order will allow activities other than moving vehicles (such as children's play), to take place legally on streets. A speed order will allow the traffic authority to define an appropriate design speed for the Home Zone.

3.50 We will consider proposals for Home Zones on a site by site basis.

General design considerations

3.51 If you want to progress proposals that include Home Zone concepts, you should discuss your ideas with us and the planning authority at the earliest opportunity and before

The 6Cs Design Guide

you submit a planning application. You should also take account of the following general design considerations.

3.52 Location

- No areas Derbyshire, Leicestershire and Nottinghamshire are specifically excluded in principle. However, Home Zones are likely to be most appropriate in more urban areas that are well served by public transport and where car ownership may be lower than in more rural areas.
- Indications are that Home Zones may be less appropriate in housing-association and social-housing developments.

We will consider Home Zones in principle off any class of road, subject to our access policy in [Part 1](#) of this document. Where accessed off a classified (A, B or other classification) road or off a busy unclassified road, the junction must be formed in line with the Design Manual for Roads and Bridges and there must be a [length of access road](#) between the site access and the beginning of the Home Zones. The length of the access road will depend on the speed and flow of traffic on the main road, the size of the Home Zone and local topography. Each site will be considered on its merits. Home Zones on other classifications of road may normally be served by a dropped-kerb arrangement.

- It will not normally be appropriate for Home Zones to form part of a bus route.

3.53 The scale of development

- We will normally only consider Home Zones for small-scale pockets or cells of development where traffic flows are likely to be low. This applies either to a small free-standing development or any part of a large development.
- Home Zones are particularly appropriate for cul-de-sacs and small loop roads where there is little 'extraneous' traffic (traffic from outside the development). You should avoid layouts that could result in 'rat-running'.
- Normally there should be no more than 25 dwellings in each cell for a cul-de-sac and 50 dwellings where there is any form of route for vehicles through it. These limits are not intended to rule out larger developments consisting of a number of Home Zones. Cells can be arranged to form larger Home Zone developments linked by routes that allow people and vehicles to move round the development.

The 6Cs Design Guide

Figure DG5 Home Zones arranged to form a larger development

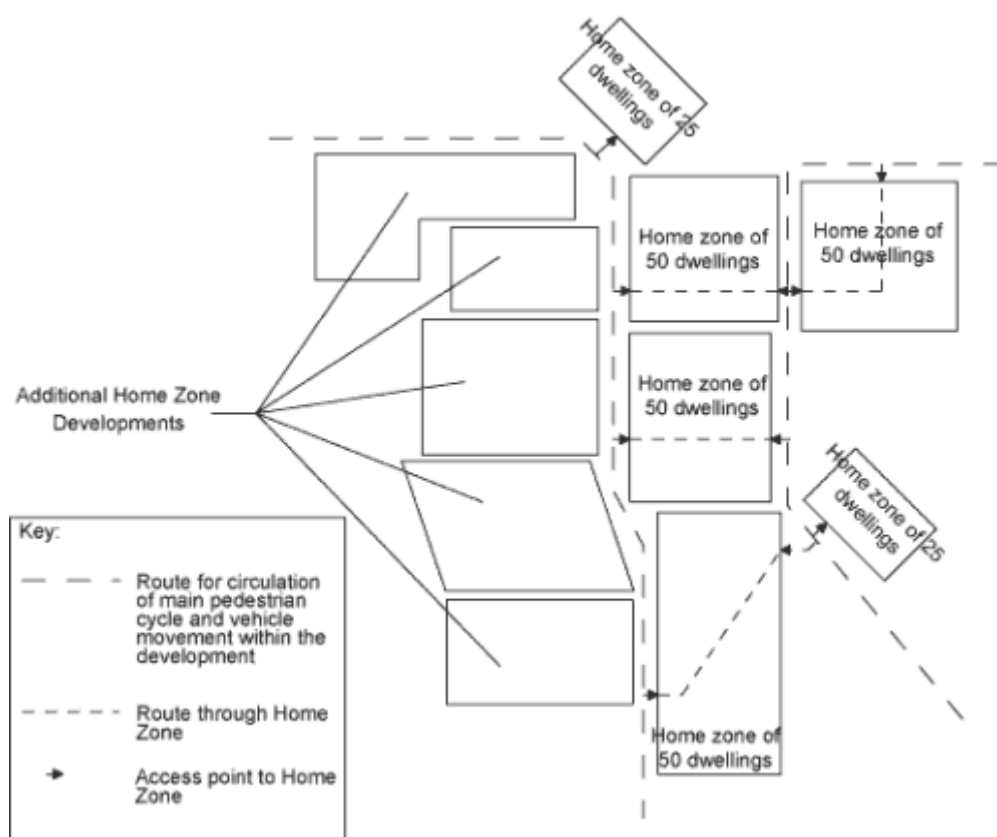

3.54 Layout

- The normal 85th %ile design speed will be assumed as 15mph, with a corresponding minimum visibility splay of 17m. We will be prepared to consider lesser visibility splay if we are satisfied that the proposed layout will achieve lower overall traffic speeds.
- You must pay particular attention to:
 - methods of controlling entry speeds to the Home Zone;
 - the width for each area in the development to allow vehicles, pedestrians and cyclists to use it safely;
 - making sure vehicles keep to the intended design speed, preferably through the design and layout of buildings and areas in between or, where necessary, by using speed-control features (with vertical features such as road humps as a last resort);
 - making the design safe for blind or partially-sighted people and those with impaired mobility;
 - accessibility for servicing vehicles, for example refuse-collection vehicles and meeting the requirements of [British Standard BS5906, 2005](#), which sets the maximum distances for carrying refuse at 25m;
 - accessibility for emergency vehicles, including meeting with any requirements of [BS5906, 2005](#) and the [Building Regulations Approved Document B, Fire Safety 2006](#);

The 6Cs Design Guide

- reducing the risk of accidents between vehicles and other highway users by making sure that there is appropriate inter-visibility (road users are clearly visible to one another);
- clearly defining the extents of the public highway;
- providing utility equipment (for example, gas, water, cable TV) and making sure access for maintenance disrupts the highway as little as possible; and
- providing clearance for opening windows, drainage downpipes and overhanging eaves where buildings front directly on to the highway.

3.55 So we can properly and efficiently consider any development proposals that either are, or include, a Home Zone, you must submit a concept proposal and supporting information in line with [Part 2](#) of this document.

3.56 We will continue to review our guidance on Home Zones in the light of any new national guidance and practical experience gained.

Adopting new Home Zones

3.57 We will normally adopt a new [Home Zone](#), subject to the requirements in [paragraph 3.40](#) onwards.

Section DG4: Mixed-use developments

3.58 Wherever possible, in the interests of road safety and to reduce environmental impacts, commercial and employment developments that generate larger goods vehicles should be kept separate from residential areas. You should design layouts so this type of commercial and employment traffic does not need to use residential roads. Similarly, Home Zones cannot be used to access these developments.

3.59 To support sustainable development, we may accept mixed-use developments that include small developments that generate very few goods vehicles, such as offices or a shop, particularly in or close to town centres.

3.60 Where a mixture of residential and commercial traffic is likely to use a road, the design elements, including materials and construction, should be based on the largest vehicles likely to use any particular section of the road.

3.61 We will normally [adopt](#) road layouts in mixed developments subject to the requirements in [paragraph 3.40](#) onwards.

The 6Cs Design Guide



Section DG5: Speed control

- [Internal roads](#)
- [The existing external road network](#)
- [Materials and construction](#)

Internal roads

3.62 For developments outside the cities, vehicle speeds within new developments should normally be controlled through the design and layout of the roads and the locations of buildings and not normally by using traffic-calming features (particularly vertical features such as road humps). Within the city areas, all new developments should be designed so that a 20mph zone can be introduced and vertical traffic calming may be used to achieve this. You should avoid:

- long straights;
- shallow bends
- roads wider than the requirements for the safe and satisfactory passage of all road users; or
- development layouts that provide greater visibility than recommended in this guidance.

You should break up stretches of straight road by either junctions or 90-degree bends as shown in [Figure DG6](#).

3.63 Where there are valid reasons why vehicle speeds cannot be controlled through site layout, and traffic calming measures are required, in the county areas you should consider horizontal measures first and you should use vertical measures only as a last resort. There is greater flexibility to use vertical measures in the cities. We will normally require commuted sum payments to cover future maintenance (see [Part 4 Section MC18](#)). Some examples of measures are shown in [Figure DG6](#). Any traffic calming should normally be in accordance with advice contained in Department for Transport Traffic Advisory Leaflets as [listed in Part 9](#).

3.64 Take particular care over choosing any type of traffic-calming measure on a proposed bus route (see Section DG6, in particular [paragraphs 3.98](#) onwards).

3.65 You must take particular care on key routes that are used or are likely to be used by the emergency services. While certain types of traffic calming (particularly vertical measures such as road humps) can have potential road safety benefits, they can also adversely affect the response times of emergency vehicles. Where traffic calming is proposed on a key route, you will need to consult the emergency services at a very early

The 6Cs Design Guide

stage (and certainly before you submit any planning application) and you will need to work closely with them in the design of any measures.

Table DG8: Maximum lengths of straight for vehicle speed control ^(a)

Maximum length of straight ^(a)	
85th %ile design speed (mph)	Maximum distance ^(b) (metres)
30	150
25	100
20	60
15	40

(a) This is the maximum distance between junctions, 90-degree bends or a speed control feature

(b) Distance between curves is measured between the tangent points.

3.66 Where any form of vertical calming feature is proposed, you should not site it within 25m of the edge of a structure, for example, a bridge or culvert. You should also site such features clear of private accesses and driveways to avoid problems of vehicles 'grounding' as they turn into or out of the accesses or drives.

3.67 We will be prepared to consider other methods of vehicle speed control in the light of practical experience of their effectiveness and any further research. However, because of problems with noise and vibration, we will not normally accept 'rumble strips'.

Figure DG6 Some examples of speed control features

The 6Cs Design Guide

Figure DG6a Speed control bend (please also see [Part 4, paragraph 4.91](#))

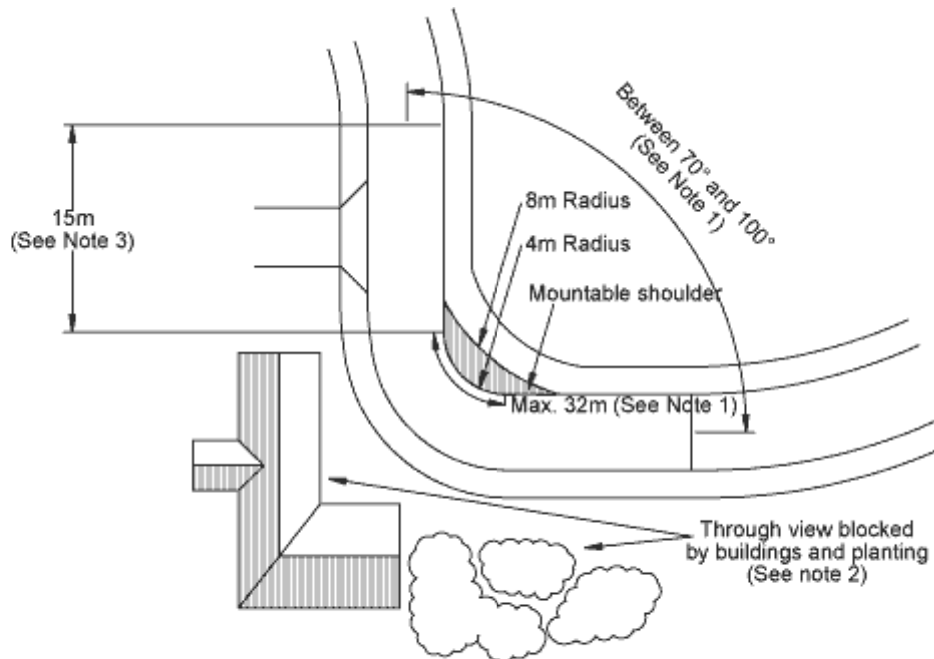

Notes:

1. Change in direction to be between 70° and 100° over a maximum distance of 32m measured along the inside kerb.
2. The through view beyond the bend on to the approach should be blocked by buildings, walls or dense planting etc.
3. A 15m separating straight is required after the speed control bend if the road curves in a reverse direction
4. There should be no vehicular accesses over the length of the forward visibility curve

Figure DG6b Chicane

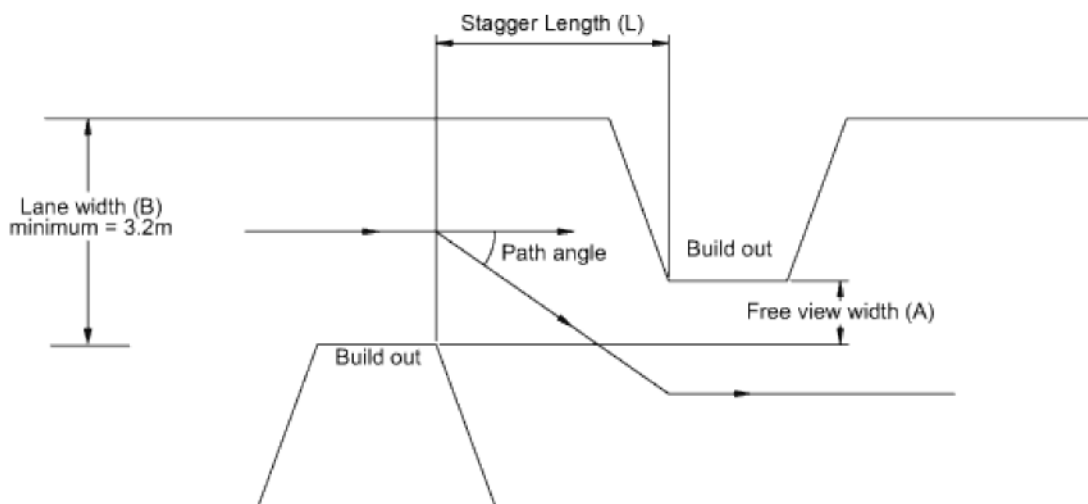

- Free View Width (A) - The width of the central gap between build outs on opposite sides
- Lane Width (B) - The average width between the build out and the opposite kerb
- Stagger Length (L) - The length between the start of the stagger on the offside and the end of the stagger on the nearside
- Path Angle - The angle through which the traffic lane is displaced. This should be minimum of 20° for design speeds of 15mph and a minimum of 15° for design speeds of 25mph

The 6Cs Design Guide

Stagger length and car speeds and Minimum dimensions of stagger length for larger vehicles

Lane width 'B' (metres)	Free view width 'A' (metre)	Stagger length 'L' to achieve the required vehicle speed in chicane 15 mph	Stagger length 'L' to achieve the required vehicle speed in chicane 25 mph		Stagger length 'L' (m) needed for a free view width of 0.0m	Stagger length 'L' (m) needed for a free view width of 0.0m	Stagger length 'L' (m) needed for a free view width of 0.0m
3.2	+1.0	6m	14m	Lane width	3.2m	3.5m	4.0m
	0.0	9m	18m				
	-1.0	12m	18m				
		9m 11m	11m 15m 19m	Artic lorry	20	15	11
3.5	+1.0		9m	Rigid lorry	12	9	7
	0.0		12m				
	-1.0		15m				
				Single decker bus	13	11	9

Figure DG6c Example of chicane including cycle 'bypass'

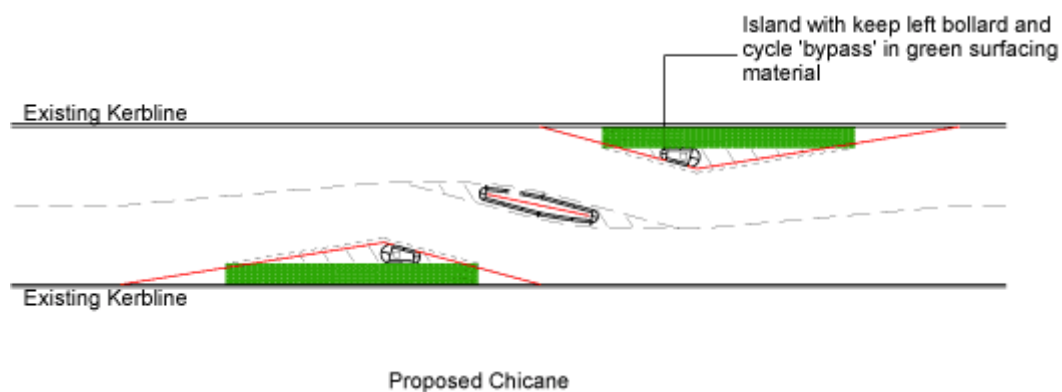

Note: Length of cycle lane to be agreed

The 6Cs Design Guide

Figure DG6d Junction table (please also see [Part 4, paragraph 4.86](#))

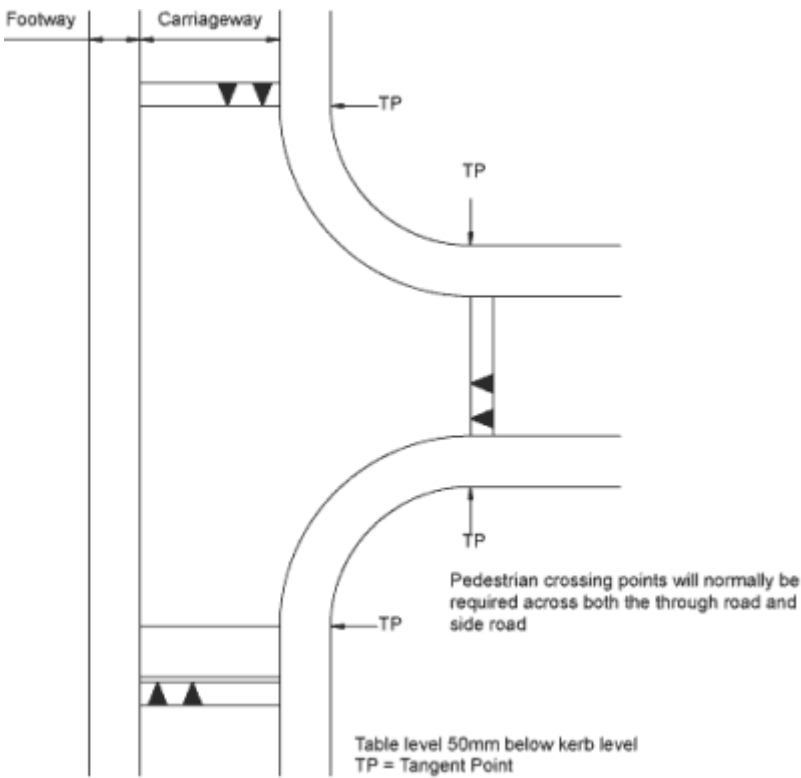
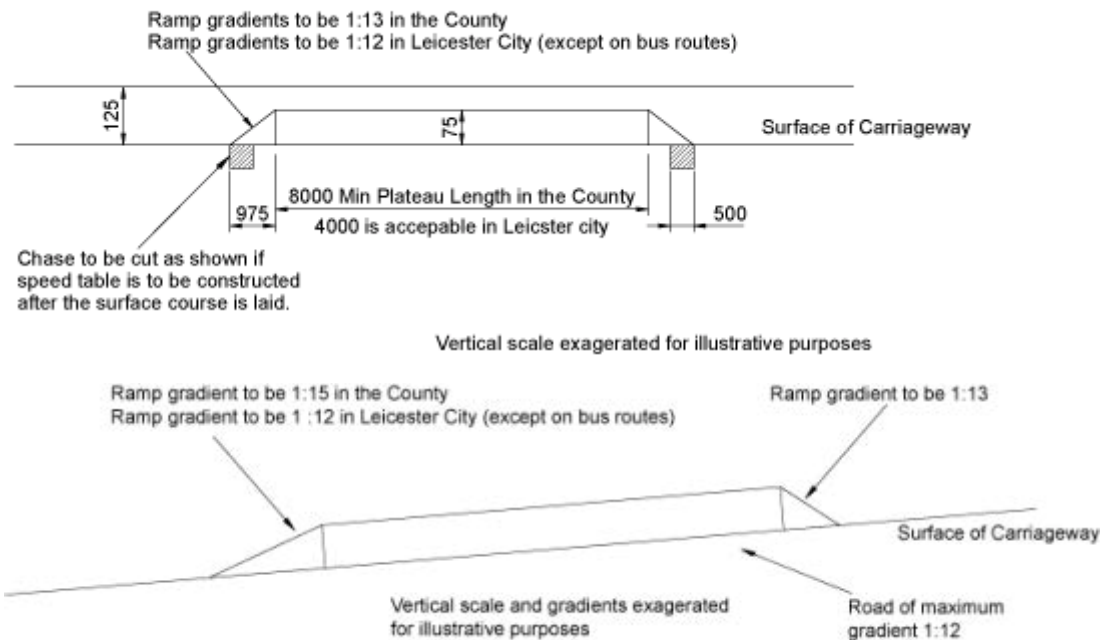

Figure DG6e Cross section of speed tables with alterations for steep roads shown in lower diagram (please also see [Part 4, paragraph 4.86](#))

All construction joints to be saw cut and painted with bitumen in accordance with BS594 part 2



The 6Cs Design Guide

Figure DG6f Example of vehicle speed control by development layout

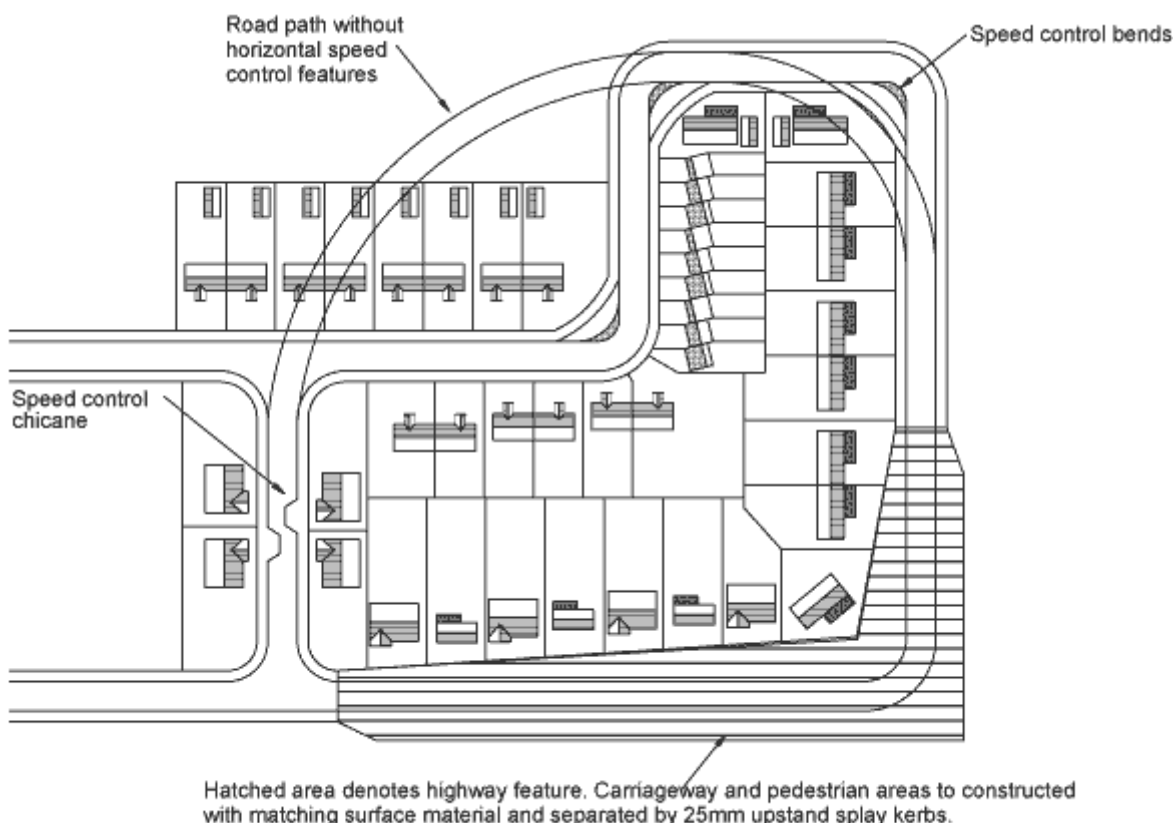

Note: Please see our [standard drawings](#) for junction tables, speed cushions and road humps.

The existing external road network

3.68 Where a development requires speed-control measures on the existing external highway network, for example, to help minimise its impacts or to achieve safe site access, there will have to be an additional public consultation separate from the planning process including advertising of features and where appropriate a different speed limit. These separate consultations are required even where the development has received planning permission. Because of problems with noise and vibration, we will not normally accept 'rumble strips'.

3.69 These consultations can often be an extensive and lengthy process, particularly where statutory procedures are involved. You will normally be required to fund all costs associated with these consultations.

3.70 We will normally seek to secure the speed-control measures and the funding of any associated costs through an appropriate legal agreement.

3.71 You should get early advice on the likely timescale and procedures involved for your specific proposals. Take this information into account when you draw up the programme for your proposed development and in any negotiations that you may have with the landowner of the development site.

The 6Cs Design Guide

In Leicester City, on residential distributor roads vertical features can only be introduced after discussions with the appropriate Cabinet Lead. Speed cushions are normally preferred for residential distributor roads. However, if road humps are the only solution these should be a maximum of 65mm in height (possibly 75mm subject to agreement) and over 7m in length (only on bus routes). All traffic calming installed on the existing road network as part of a s278 agreement should include a speed reduction feature prior to any vertical feature where the 85th percentile approach speed is greater than 30mph.

Materials and construction

3.72 Please refer to [Part 4](#).



Section DG6: Public transport

- [Introduction](#)
- [Bus services](#)
- [Pedestrian access to bus routes](#)
- [Bus stop location and design](#)
- [Designing bus routes](#)
- [Bus-only links](#)
- [Public-transport interchanges](#)

Introduction

3.73 In the interests of sustainability, new development should be located in areas well served by alternative means of transport to the private car, including buses, taxis and cycle routes.

3.74 Particularly if your development requires any form of transport assessment (see [Part 2 Table PDP1](#)), you should seek early advice from us and bus operators on:

- existing bus services in the area, and any proposals to upgrade services or facilities, for example, introducing the real-time bus information system 'star trak';

(A system which provides waiting passengers with details of when the next bus is due and the route number. This is known as 'real-time information', and the system currently used in Leicester, Leicestershire, Nottinghamshire and Derbyshire is 'star trak'.)

- how best to serve the proposed development, for example, how appropriate would it be to:
 - operate a bus service through the development (bearing in mind the walking distance guidance in [paragraph 3.81](#) below); or

The 6Cs Design Guide

- enhance existing services adjacent to the development and provide improved footway links to the bus stops;
- where a service is to operate through the development, how best to plan a route and where best to locate bus stops and any lay-bys to encourage maximum use of the service; and
- what other measures might be required to improve public transport provision, for example, more frequent services or improvements to existing bus stops.

3.75 You should discuss these issues and agree the general approach as soon as possible as the outcomes are likely to have a bearing on:

- the development's layout;
- the transport assessment;
- any travel plan;
- any likely highway mitigation works; and
- parking provision.

3.76 Additionally, where a development requires a concept proposal (see [Part 2 paragraph 2.17](#)), you should clearly identify and detail any agreed public transport facilities and routes.

Bus services

3.77 Where you are proposing public transport as a sustainable alternative to using cars, the service must realistically be capable of delivering a shift away from the car. To achieve any significant shift, it is likely that the service will have to be more frequent than once an hour during the day, Monday to Saturday, with an evening and Sunday service for larger developments.

3.78 We will consider developments on a site-by-site basis. We will assess any estimates for likely levels of public transport use included in any transport assessments or draft travel plans, against existing or proposed bus routes, vehicle capacities and timetables. We will need to be satisfied that a public transport service can be provided that is realistically capable of achieving the proposed level of use by the development's occupants.

3.79 We will also consider any phasing in of services, particularly for larger developments, on a site-by-site basis. Issues that will need to be discussed and agreed include:

- the initial service provision to a development site, for example, taxibuses and demand-responsive transport (services that operate in response to specific requests from residents) to serve the first occupiers of new residential developments;
- at what stage the growing numbers of houses, employees and shoppers will trigger an increase in the capacity and frequency of services;
- the need for priming initial services by using subsidised or free bus passes, residents' travel packs and so on; and
- if and when a new service might become self-funding.

3.80 Through the planning process we will normally recommend to planning authorities that developers fund public transport services through a Section 106 agreement which, among

The 6Cs Design Guide

other things, specifies the level of support which must be provided to the service and over what time period. While we will seek to work with you to reach a suitable agreement, we will resist (for example by recommending refusal of any planning application) development proposals that do not meet the policies and objectives set out in this document, (see [Part 1, paragraph 1.24](#) onwards)

Pedestrian access to bus routes

3.81 Generally walking distances to bus stops in urban areas should be a maximum of 400m and desirably no more than 250m. In rural areas the walking distance should not be more than 800m.

3.82 You should design pedestrian routes to bus stops to be as direct, convenient and safe as possible to encourage use of public transport. You should design the routes in line with principles set out in [paragraph 3.111](#). They should:

- enjoy good natural observation from neighbouring buildings;
- be well lit; and
- be carefully designed so any planting minimises opportunities for crime.

You should place bus stops in employment or commercial areas near building entrances and avoid locations where passing traffic speeds are high. In rural areas there should always be at least a footway from any proposed development to the nearest bus stop.

3.83 Where there is a footway on the opposite side of the road, a pedestrian crossing point should normally be provided next to a bus stop, and designed in line with the appropriate [standard drawing](#). The crossing point should be located as close as is possible to the stop, bearing in mind safety considerations.

Bus stop location and design

3.84 You should think carefully about the proposed layout of the development in the immediate vicinity of a bus stop to:

- make sure bus drivers and passengers waiting at the stop have ample time to see each other;
- make sure vehicles overtaking a stationary bus have satisfactory forward visibility;
- prevent parked vehicles blocking bus stops;
- avoid safety conflicts with road junctions, pedestrian or cycle crossings and so on
- avoid interference with accesses to properties;
- make sure there is satisfactory drainage where raised kerbing is installed (see [paragraph 3.88](#));
- minimise risks to personal safety and opportunities for crime, in line with principles similar to those set out in [paragraph 3.111](#); and
- protect bus stops from obstruction.

3.85 You should not site bus stops within 30m of vertical traffic-calming features (including domed mini roundabouts). This is to minimise the risk of passengers waiting to get off the bus being thrown about the inside of the bus, and to allow boarding passengers time to sit down.

The 6Cs Design Guide

3.86 To erect a new bus stop or relocate an existing bus stop on an existing public highway you need to get agreement from:

- us;
- the police;
- the local parish council (if appropriate) / local ward councillor;
- bus operators; and
- in Leicester City, frontages directly affected must be notified in writing and allowed a reasonable time to respond (usually two weeks).

3.87 The minimum footway width at a bus stop should normally be 3m. Where a shelter is to be provided (see [paragraph 3.89](#)), there should be at least 0.5m clearance between any part of the shelter and the edge of the carriageway. There should be a clear footway of at least 1.3m (1.8m in the city) between the shelter and the rear edge of the footway (both for cantilever-style shelters where the roof extends beyond the support and enclosed shelters). Where you cannot achieve this, but there are no alternative locations to site the shelter, then we will consider site-specific shelter designs.

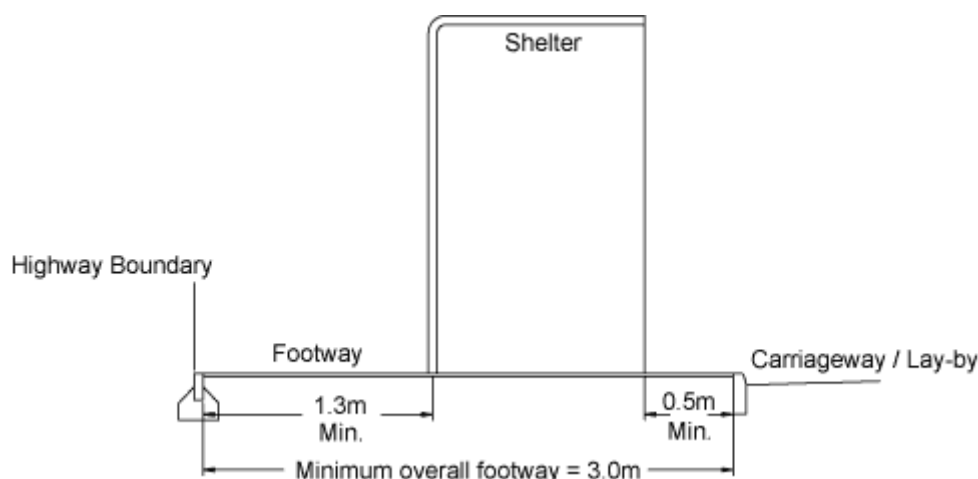

Figure DG7 Bus shelter siting

3.88 Accessible raised kerbing to a height of 180mm will be required at all stops. The length of raised kerbing should normally be 6m in the county and 4m in the city (plus 1m transition kerbs at either end) with a minimum run of 3m (plus transition kerbs). The stop should be located and laid out so a bus can stop parallel to and close to the raised kerbing.

The 6Cs Design Guide

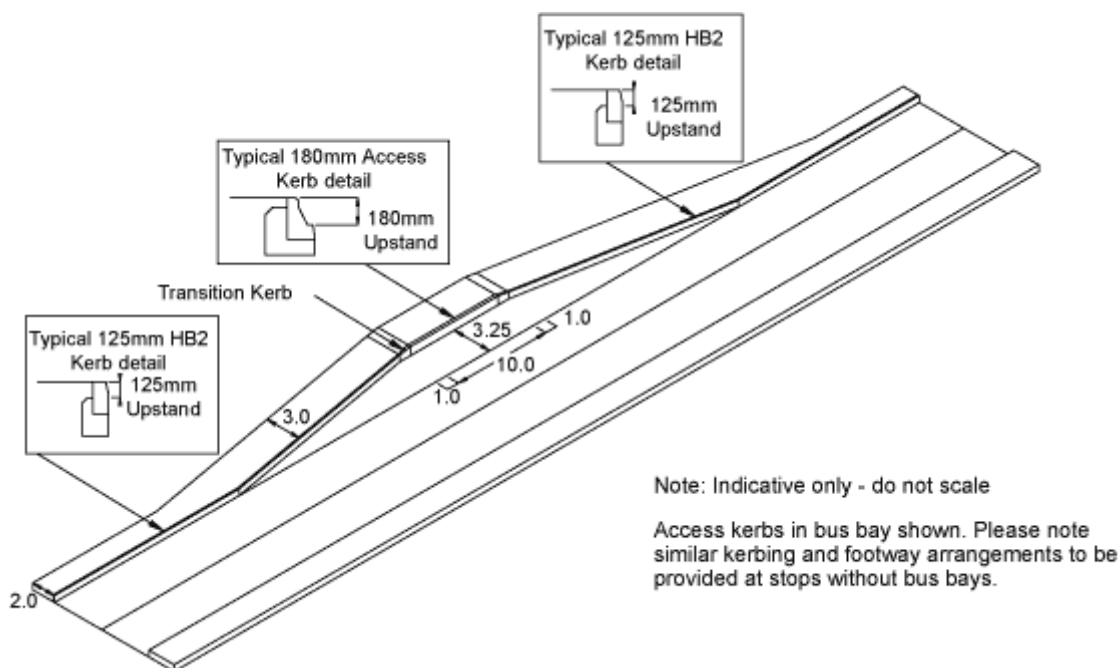

Figure DG8 Raised kerbing at bus stops

3.89 Shelters will usually be required at key access points where there are likely to be higher passenger flows, for example, near:

- high-density housing;
- business parks;
- local shops, schools, hospitals or other significant community facilities; or
- in rural areas where public transport services are infrequent and people may have to wait some time for a bus.

3.90 Where we will not own a bus shelter, you will need a license from us to erect it. Where shelters will display advertising, you will also need planning permission from the planning authority. We will also need to be satisfied that appropriate arrangements are in place for the shelter's future maintenance.

Note: in Leicester City new bus shelters may only be introduced through the contract we have with JC Decaux. All installation and maintenance costs will be met by the developer.

3.91 We will consider how bus service information will be provided at bus stops on a site-by-site basis. Depending on the nature and size of the development, the information provided could consist of:

- a simple timetable;
- a more comprehensive display including a bus route map and a plan showing pedestrian links to surrounding facilities; or
- real-time bus information for key stops.

The 6Cs Design Guide

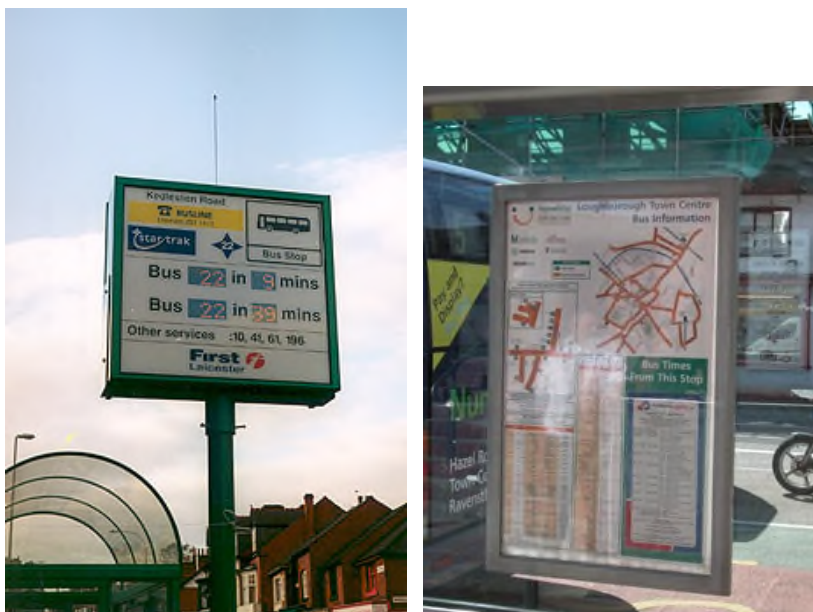

Figure DG9 Examples of bus service information

3.92 Lay-bys will normally only be required at places where a large number of people will want to board a bus such as local shops, schools or other locations where buses may wait for a time and could cause localised congestion or be a safety hazard.

3.93 Where lay-bys are to be provided, they should normally be designed to accommodate 15m long buses as indicated in Figure DG10 below.

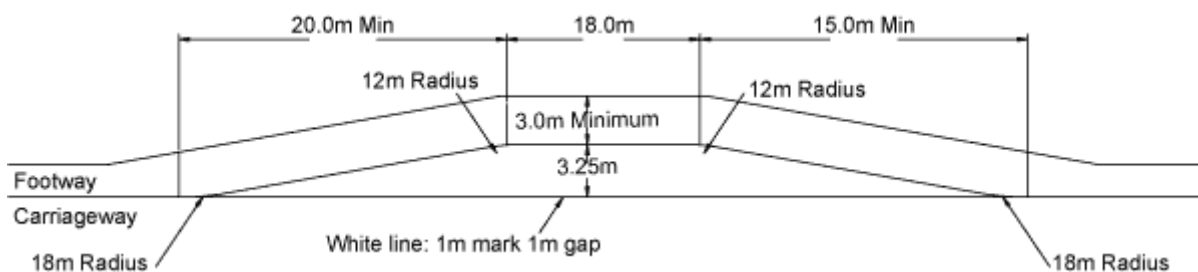

Figure DG10 Bus lay by

3.94 When the development is being constructed, you should, where appropriate, make provision for shelter lighting and real-time bus information facilities to be installed at a future date. This should include, for example, installing suitable underground ducting.

3.95 We will normally require a [commuted sum payment](#) to cover future maintenance of bus stop facilities that we are to maintain. Please see [Part 4](#) for further details.

Designing bus routes

3.96 Where a development is likely to be accessed using public transport, any roads which buses are likely to run along should normally be at least 6m wide (subject to [tracking assessment](#)) and should be reasonably straight. A more generous [swept path](#) is also likely to be required to take account of where vehicles might park on-street, for example. It will not be acceptable to route bus services along either shared-surface roads (that is, access

The 6Cs Design Guide

ways, see [Section 3](#)) or through Home Zones. We may consider exceptions for services operated by smaller vehicles (for example, minibuses) where there is no practical alternative to serving the development by public transport.

3.97 Buses should be able to enter and exit from the development as easily and directly as possible. Where appropriate, bus-priority measures such as bus lanes and traffic signals should be used to help bus movement. You should discuss and agree provision for specific sites with us and bus operators.

3.98 Any horizontal speed-control features, including 90-degree bends and horizontal traffic calming measures ([for example, chicanes](#)), should normally be designed to accommodate the swept path of a 15m long rigid bus (the largest vehicle size now permissible). You should discuss and agree design details jointly with us and the bus operators. You will need to give us computer assessments of vehicle swept paths to demonstrate that your proposals will work in practice.

3.99 You should not use vertical traffic calming on bus routes unless there is no other speed control solution. If there is no suitable alternative you should:

- use round-top humps, 5m long with a sinusoidal profile as described in TRL information note [417](#) (and possibly [377](#));
- build any tables to a minimum length of 9m with 1:13 maximum ramp slopes;
- keep humps or tables no higher than 75mm. Bus companies prefer lower heights and we will consider these on a site-by-site basis, as long as any reduction in height does not significantly affect speed control in the development; and
- consult with bus operators (at the earliest opportunity).

Note: Please see our [standard drawings](#) for junction tables, speed cushions and road humps.

Bus-only links

3.100 For certain developments, particularly larger sites, providing bus-only links may be appropriate. You should provide these where:

- there is a clear need;
- they will save time over a more indirect route;
- they would benefit integration with neighbouring development; or
- they would help to minimise impacts to an existing bus service.

3.101 You should discuss and agree requirements for specific sites jointly with us and the bus operators. But generally you will need to provide (and pay for) traffic regulation orders (TROs) to restrict the link's lawful use. You also need to consider the following.

- The link's design should be self-enforcing and not simply rely on the TROs to control its use by other vehicles. If it is likely that the link would be used by other traffic, it will normally need an appropriate control system such as an automatic rising bollard.
- Its width will depend on whether the link is to be two-way or one-way or [shuttle-working](#).

The 6Cs Design Guide

- The link should enjoy good natural observation and not be fronted by blank building walls or enclosed by high boundary walls or fences.
- How best to minimise the impact of the link on existing and proposed properties
- Where possible you should include walking and cycling links to complement it.

3.102 We will normally need a [commuted sum payment](#) to cover the future maintenance of any control systems. Please see [Part 4](#) for further details.

Figure DG11 Example of a bus only link

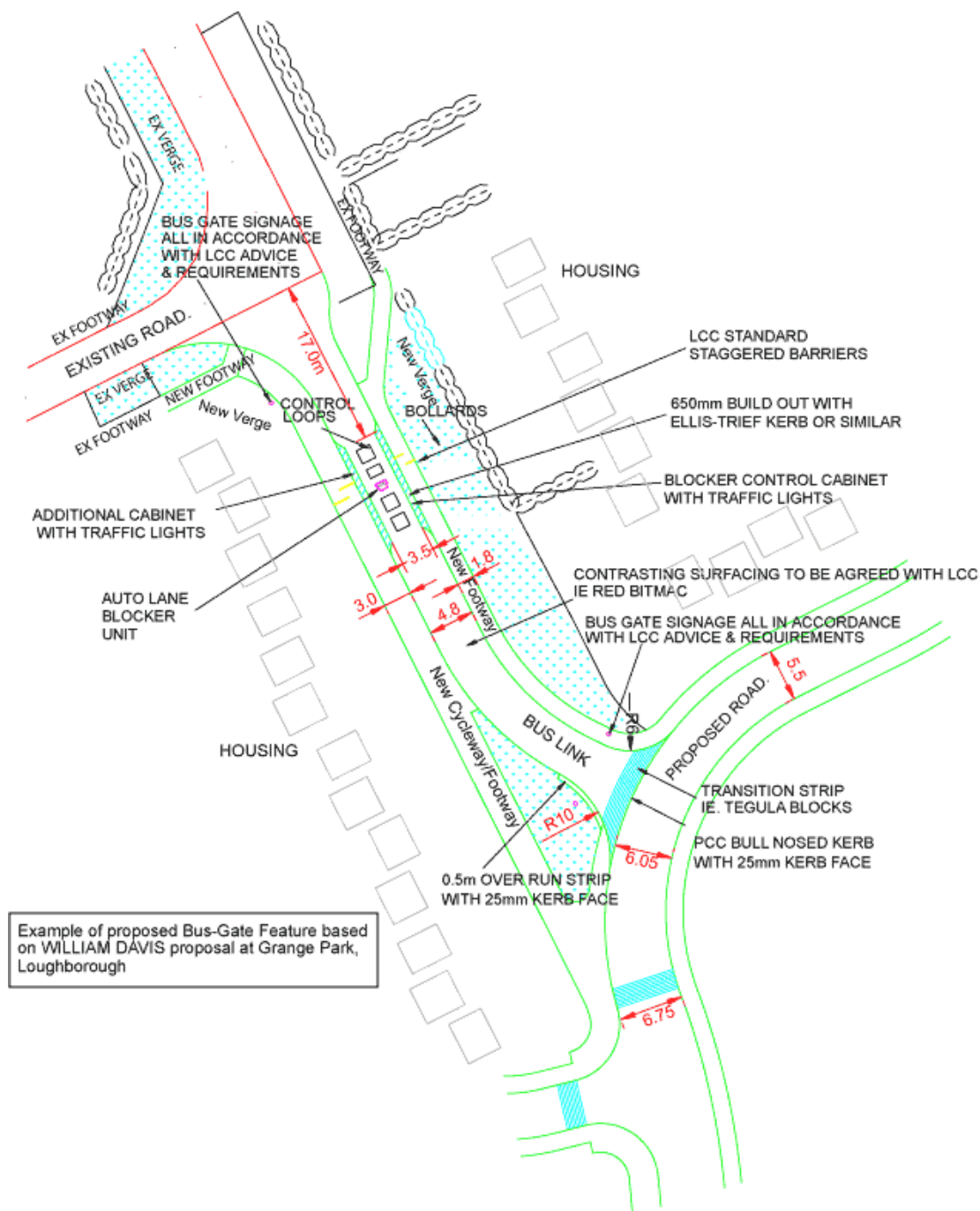

The 6Cs Design Guide

Public-transport interchanges

3.103 It may be appropriate for particularly large developments which generate high passenger numbers, and which are located at key points on the road network, to provide a public-transport interchange with comprehensive facilities. Examples of developments and locations might include:

- major retail parks;
- hospitals;
- business parks;
- significant new housing estates;
- extensions to an existing major development where it will help to encourage greater use of public transport;
- developments at locations where bus routes intersect; and
- where major orbital and radial roads intersect.

3.104 Examples of facilities might include:

- a waiting room or mini bus station;
- comprehensive timetable and route information, including real-time bus information;
- secure facilities for leaving luggage;
- toilets;
- refreshment facilities; and
- secure cycle parking.

3.105 We will consider development proposals and maintenance responsibilities on a site-by-site basis.

The 6Cs Design Guide



Section DG7: Pedestrians and cyclists

- [Introduction](#)
- [General geometry](#)
- [Road crossings](#)
- [Signing for routes](#)
- [Materials and construction](#)
- [Adopting new routes](#)
- [Existing rights of way](#)
- [The existing and planned cycle route network](#)
- [Providing cycle parking and other facilities for cyclists](#)

Introduction

3.106 Walking and cycling offer real alternatives to journeys by car particularly over shorter distances. In the interests of sustainability new developments must make appropriate, high quality provision for pedestrians and cyclists and where it is necessary to break a road link in order to discourage through traffic, it is recommended that links for pedestrians and cyclists are maintained. In respect of cycling, this includes provision of appropriate parking and supporting facilities (for example showers and lockers) as detailed in [Section DG16](#).

General geometry

3.107 Table DG9 sets out general geometry for pedestrian-only routes, including [footways](#) and [footpaths](#). Routes for joint use by pedestrian and cyclists, or by cyclists only, are covered in Table DG10. Surfaces used by pedestrians should be free from hazards that could cause them to trip.

The 6Cs Design Guide

Table DG9: Pedestrian-only routes

Location	Minimum width	Minimum width past an obstacle ^(a)	Longitudinal gradient	Crossfall
Normal residential, commercial and industrial sites	2m	1.2m Maximum length of an obstacle: 6m	Minimum:1:100 Maximum:1:20 ^{(b)(c)}	1:35
Shopping areas	4m	1.2m Maximum length of an obstacle: 6m	Minimum:1:100 Maximum:1:20 ^{(b)(c)}	1:35
Bus stops	3m	1.2m Maximum length of an obstacle: 6m	Minimum:1:100 Maximum:1:20 ^{(b)(c)}	1:35
Outside schools ^(d)	3m	1.2m Maximum length of an obstacle: 6m	Minimum:1:100 Maximum:1:20 ^{(b)(c)}	1:35

(a) Includes things such as bollards, sign posts, guard railing, lamp columns and utility equipment (for example gas, water, cable TV). You should liaise with utility providers to achieve this for equipment installed while the development is being built. The clearance should be increased to 2m where pedestrian flows may be heavy, in the region of 500 an hour. Please see [Section DG11](#) for more guidance on locating utility equipment.

(b) Taking into account the needs of people with impaired mobility, we may be prepared to consider a relaxation to 1:12 on sites with particularly difficult topography.

(c) Crossovers to private drives and parking should be carefully designed so as not to create inconvenient cross-falls for pedestrians.

(d) Includes [higher and further education facilities](#).

Table DG10: Joint use of cycle and pedestrian routes and cycle-only use

Type ^(a)	Width ^(b)	Centre-line radius	Forward visibility	Crossfall ^(d)	Longitudinal gradient
Joint use with pedestrians	3.0m ^(e)	6m	20m	1:35 (no adverse camber)	Min: 1:100 Max: 1:20
Cycle only	2m ^(e)				

(a) Normally provide joint use, except where cyclist and pedestrian flows are likely to be high, for example, outside a school or in a shopping area. Where cyclists and visually-impaired pedestrians could meet, you should provide warning surfaces to [standard drawings](#)

The 6Cs Design Guide

- (b) Minimum width past an obstacle as in Table DG9 above, including accompanying note.
- (c) A 50mm white line should be provided, offset 500mm from the kerb and parallel to it.
- (d) Crossovers to private drives and parking areas should be carefully designed so as not to create inconvenient cross-falls for pedestrians.
- (e) Where a route is bounded (for example by a wall, fence or bridge parapet) you should normally add an additional 0.25m for each side bounded where the boundary height does not exceed 1.2m, and an additional 0.5m for each side bounded where the boundary height exceeds 1.2m.

3.108 Please contact the relevant authority for cycling design advice.

3.109 Porch roofs, awnings, garage doors, bay windows, balconies or other building elements should not oversail (project over) footways at a height less than 2.6m; the headroom over routes used by cyclists should normally be 2.7m. If any part of a building projects over the [adoptable](#) highway, you will need to apply to us for a license under Section 177/178 of the [Highways Act](#) before we adopt your roads. If you do not apply for a license, we may not adopt your roads. Where a route runs alongside a road, its rear edge should normally coincide with the rear of visibility splays at junctions and on bends so the splay is clear and pedestrians and cyclists do not impede visibility. You should achieve this either by widening the footway or providing a verge. Grassed verges should be at least 1m wide and minimum area of 10sqm, otherwise you should use hard landscaping.

3.110 Routes that run separately from a road are not normally encouraged; for example, the [Manual for Streets](#) sets out that cyclists should generally be accommodated on the carriageway in residential areas. But where a separate route can be justified, for example, where it is necessary to break a road link to discourage through traffic or to give a more direct link to shops, schools, community facilities or public transport, you should take care to minimise crime opportunities. We will generally work with the relevant police force's Architectural Liaison Officer (ALO) to promote personal safety, and you should seek early advice from the FALO on proposals for specific sites. (Please see [paragraph 3.122](#) about [adopting](#) routes.)

3.111 As general guidance however, justified separate routes should normally meet the following criteria.

- They should be in the open wherever possible. Where this is not possible, buildings should be designed with windows overlooking the route. You should avoid blank walls or close-boarded fences and so on.
- Routes should be as short, straight and direct as is possible, ideally with each end being clearly visible from the other.
- Routes should be well lit.
- Within 2m either side of the route, any planting should be low, ground-cover only for at least 1m, grading to no more than 1m high. Plants should not have thorns. If a route is curved or has corners, you should increase the 2m distance to maintain satisfactory visibility.
- You should take care to make sure that any planting, particularly trees, would not reduce illumination from the lighting.

The 6Cs Design Guide

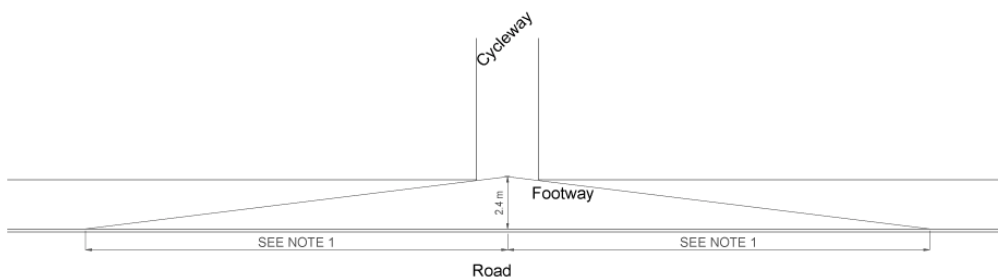

Figure DG12 Examples of a poor pedestrian link (left) and a good pedestrian link (right)

3.112 Where a separate route joins another pedestrian or cycle route which runs alongside a carriageway (vehicle route), you should design its junction with the road network:

- so the route joins at 90 degrees to the traffic flow;
- to include barriers as in our [standard drawings](#) to prevent users, particularly children, from proceeding straight out into the road and also to stop use by vehicles; and
- to include visibility splays for cycle routes so that cycles emerging from the route can see and be seen. Visibility should normally be provided as indicated below.

Figure DG13 Visibility splays at junctions for cyclists



NOTE 1: Length depends upon speed of vehicles on road.
For distances, see table DG4

Road crossings

3.113 The guidance on road crossings applies both to where pedestrians or cyclists are travelling:

- across a road; or
- along a road and they cross a side-road junction which includes any access more than a simple footway crossing.

3.114 In either case, appropriate crossing facilities will normally be required. You should agree requirements for specific sites with us in the early stages of preparing your development proposals.

The 6Cs Design Guide

3.115 The normal basic requirement is to provide dropped kerbs with buff-coloured tactile paving as in our [standard drawings](#). Where a refuge in the middle of the road is required, you should provide this to standard drawings with:

- a 2m width for pedestrian-only use and 2.5m where it will be used by cyclists; and
- a 3.2m clearance to the carriageway edge on either side.

3.116 Please contact the relevant authority for cycling design advice.

3.117 In very large developments it may be necessary to consider some form of light-controlled crossing such as a Zebra, PELICAN or TOUCAN, to provide safe and attractive routes for pedestrians and cyclists.

3.118 Whatever the crossing type, if you need to provide guard railing to guide pedestrians or cyclists, it should be high-visibility railing as in our [standard drawings](#).

3.119 Where cyclists and visually-impaired pedestrians could potentially meet, you should provide surfacing to guide the visually-impaired users along the correct pedestrian route, in line with Department for Transport's '[Guidance on the use of Tactile Paving Surfaces](#)'.



Signing for routes

3.120 Direction signing can help to highlight and promote the use of a route, although you should take care to minimise clutter and visual disruption. You should identify any requirements for specific sites and agree them with us in the early stages of preparing your development proposal. Any signing and lining you provide should be designed in line with the guidance in [Part 4](#) and our [best practice document](#).

Materials and construction

3.121 Please refer to [Part 4](#).

Adopting new routes

3.122 Where new footways and cycleways are located alongside roads that we are adopting, we will usually adopt them as publicly-maintained footways and cycleways as long as they have been constructed to our satisfaction.

3.123 We may also consider adopting other routes where they serve a strategic purpose, for example, where they form part of a wider network (existing or planned) or provide a more direct link to:

- major employment or a shopping centre;
- a school or other community or leisure facilities; or
- a bus stop or public transport;

providing that the routes have been constructed and lit to our satisfaction.

The 6Cs Design Guide

3.124 [Part 5](#) provides details on procedures for adopting new routes under Section 38 agreements. [Part 6](#) covers works on the existing public highway under Section 278 agreements.

3.125 We will not normally adopt routes:

- that serve only private properties, public open spaces, play areas and so on;
- where there is already an existing satisfactory alternative adopted route; and
- where any adjacent routes they might link to are not adopted, or are of a poor standard.

3.126 You should discuss adoption issues with us in the early stages of preparing your development proposals.

Existing rights of way

3.127 You cannot obstruct or divert an existing right of way without obtaining the [Rights of Way Authority's](#) consent (even if planning permission has been granted). You should accommodate an existing footpath on its existing right of way wherever possible. If, however, the Rights of Way Authority agrees in principle to a diversion, you will need a diversion order. The [planning authority](#) usually processes applications to divert rights of way using powers under the [Town and Country Planning Act 1990](#).

3.128 In all cases, the route of existing rights of way should normally be designed in line with the guidance set out in this document. You should take particular care to design bridleways to prevent their misuse by motor vehicles.

3.129 Where a development requires highway rights to be extinguished (removed), for example, to stop-up a length of road, this also should normally be done by the planning authority under the Town and Country Planning Act. You should get our agreement to your proposals to extinguish highway rights before you submit a planning application.

3.130 The procedures involved in making diversion orders or orders to extinguish existing highway rights can be very lengthy. You should get advice on the likely timescale and take this into account when you programme your proposals. Whether or not any order is successfully made, you will normally be responsible for paying all costs associated with processing it.

3.131 A guidance note for designers, developers and planners on Development and Public Rights of Way has been adopted by Derby City, Derbyshire County, Leicester City and Leicestershire County Councils. This guide can be viewed at [here](#). For guidance about Rights of Way in Nottingham City Council and Nottinghamshire County Council please contact the relevant authority ([see Appendix A](#)) for contact details.

The existing and planned cycle route network

3.132 We are working along with organisations such as Sustrans and other highway authorities to provide a safe and convenient cycle network throughout our areas. Where a site stands close to this network, you will normally be expected to provide links to it as part of your proposals. You will also be expected to contribute towards its completion where it is reasonable to ask you to do so.

The 6Cs Design Guide

Providing cycle parking and other facilities for cyclists

3.133 Please see [Section DG16](#).

Section DG8: Horse riders

3.134 Horse riders are entitled to use bridleways, all-purpose roads and byways open to all traffic. You should consider them in the design and safety audit of all developments which either:

- affect an existing or future bridleway; or
- affect an existing or future all-purpose road that carries horse riders.

3.135 The guidance in this section relates generally to lower-speed single carriageway roads. For facilities for horse riders in other circumstances, please refer to [TA57/87 Roadside Features](#), section 11.

3.136 Bridleways carry horse riders, cyclists and pedestrians, and you should take the needs of all these groups into account.

3.137 For horses, a blinded crushed stone surface is often best, being hard wearing without being as hard on hooves as asphalt.

3.138 Where a new junction is formed between a bridleway and a road, a Pegasus crossing facility should be provided. In addition, a bridleway sign should be erected.

3.139 New roads likely to carry significant horse traffic (more than 100 passages a week) may need verges suitably surfaced for horses. For particularly well-used routes, for example, near a riding school, you should consider providing a separate horse trackway beyond the verge, possibly separated from vehicles by fencing or a hedge.



Section DG9: Lining, signing and traffic regulation orders

3.140 You will normally be required to provide all road markings and traffic signs both on the internal development roads and on the surrounding road network where necessary. Occasionally, this may involve signing at some distance from the development, for example, for routing HGVs.

3.141 At your developments' site access, lining and signing should be provided in accordance with [Traffic Signs Regulations and General Directions 2002](#) (TSRGD). For priority junctions within developments, junction lining and signing:

- will not normally be required in residential developments;

The 6Cs Design Guide

- will not normally be required in B1 use class office developments; but
- will be required in all other employment and commercial developments, provided in accordance with TSRGD.

Other types of development will be considered on a site-by-site basis.

3.142 In addition to markings at junctions as indicated above, carriageway centre-line markings will:

- not normally be required in residential developments;
- will not normally be required in B1 use class office developments; but
- will be required in all other employment and commercial developments, provided in accordance with TSRGD.

Other types of development will be considered on a site-by-site basis.

3.143 Signing and lining, in accordance with TSRGD, should also be provided at all road humps/tables, at any entry ramps to side roads and at any other traffic calming features. Where parking bays are not clearly defined, markings will be required to segregate them from the carriageway.

3.144 Wherever signing and road markings are required, you should normally provide them in line with the requirements set out in [Part 4, Section MC12](#), including the need for illumination. You should establish at an early stage in the detailed design process which signs will require illumination to make sure that appropriate electrical supplies are installed during construction work.

3.145 Where a development requires changes to an existing traffic regulation order (TRO) or a new order is required, you will normally be required to pay all costs associated with this, including all consultation and legal costs. TROs are subject to statutory [procedures and consultations](#). This can be a very lengthy process and a successful outcome is not guaranteed. You should get advice on the likely timescale and take this into account when you programme your proposals.

Section DG10: Street lighting

3.146 We normally require a suitable system of street lighting on all [adoptable roads](#), which we will normally design for you in areas to be adopted. This is important for both road safety and to help promote personal safety and minimise crime opportunities. It is also important that you plan the lighting at the same time as you design the street layout. Also, to encourage pedestrians to use a route and to feel safe, it is important that lighting levels are maintained at the same standard along a route, whether a route is adopted or not. There are also wider design issues. When you prepare development proposals, you should consider the purpose of the lighting, its scale and the proposed width of the street and height of the building.

3.147 For more details on lighting, please see [Part 4](#).

The 6Cs Design Guide

Section DG11: Utility equipment (for example, gas, water, cable TV)

Note: Our [standard conditions](#) applying to highway works for new development provide more advice on dealing with utility equipment during construction of your works.

3.148 Early in your planning process you should consider the location and installation of utility equipment both above and below ground, particularly where surface areas are shared. Normally, private equipment should not be located in the highway* but utility company's equipment should be. Where a shared-surface layout is proposed without a separate service margin or where a development layout is not explicitly covered by this guidance, you should hold early discussions with [utility providers](#) and supply us with details of proposed locations for utility equipment. This will enable us to consider the layout, for example, in terms of safety and accessibility.

*This can be difficult to achieve with layouts where houses are located very close to the highway boundary. However, if you do not deal with this matter, it may lead to problems in future with us [adopting](#) your road.

3.149 Any separate service margin should be at least 2m wide, in line with [National Joint Utilities Group \(NJUG\) 7](#). And any utility equipment that is above ground, for example, cabinets, boxes, pillars and pedestals should be sited so that it:

- does not constitute a danger to the public or to staff working on it;
- does not obstruct a drivers' view, for example, by siting it in visibility splays;
- does not obstruct pedestrians, wheelchairs, prams, pushchairs and so on. You should provide at least 1.2m clearance increased to 2m in areas of high pedestrian flows (500 pedestrians an hour);
- is not located within 5m of any other street furniture that would create a double obstruction to pedestrians. Any item within 5m must be in line;
- does not provide a means of illegal access to adjacent premises or property, for example, you should avoid sites alongside a high wall so the equipment cannot be used to climb over the wall;
- does not offend visual amenity (spoil the view) by restricting the outlook from the window of a house, intruding into areas of open-plan front gardens or disrupting the line of low boundary walls;
- does not spoil the view of a Grade I or Grade II listed building; or
- does not result in 'visual clutter' by being in an inappropriate place.

3.150 All apparatus above the ground should:

- be positioned so there is enough access for the equipment and the surrounding highway to be maintained and cleaned;
- not be located within any tactile paving (in the case of surface covers);
- allow space for associated jointing chambers;
- take account of known highway alterations;
- allow for future surfacing work, for example, by using raised plinths and allowing for spare cable if the boxes are raised in future; and
- meet the license requirements for listed buildings and conservation areas. You need to give special consideration to cabinet design in conservation areas.

The 6Cs Design Guide

3.151 Where equipment is to be located in a proposed [adoptable](#) highway, you should locate cabinets and so on in the verge where possible. You should leave at least 1m between the cabinet and the edge of the carriageway in rural areas and 1.5m in urban areas. Access doors should always open to the footway. If there is no verge, you must position cabinets and so on at the back of footway and keep:

- a minimum distance of 1m between the edge of an open access door and the edge of the carriageway where pedestrian flows are low; or
- a minimum distance of 2m between the edge of an open access door and the edge of the carriageway where pedestrian flows are heavy (500 pedestrians an hour at any time).

3.152 We may consider adopting any additional small areas so above-ground apparatus can meet locational requirements. If, however, you cannot meet the requirements within adoptable areas, you should locate cabinets and so on off the proposed adoptable highway. You may need an easement to allow utility equipment providers access in future for maintenance purposes.

3.153 You should locate equipment below ground in line with NGU7. You should locate any access chambers that are on the surface to:

- minimise disruption to pedestrians and provide adequate access for installing and maintaining equipment, and recovery operations;
- avoid expensive paving as far as possible, for example, tactile paving;
- avoid other utility providers' equipment;
- allow for using mechanical equipment during construction and installation, maintenance and recovery operations at the site;
- take into account any known highway alterations;
- make sure the type and construction of underground boxes allows us to raise covers and frames when we carry out resurfacing work; and
- avoid potential archaeological features, including foundations to listed buildings.

The 6Cs Design Guide

Figure DG14 Arrangement of below ground service equipment

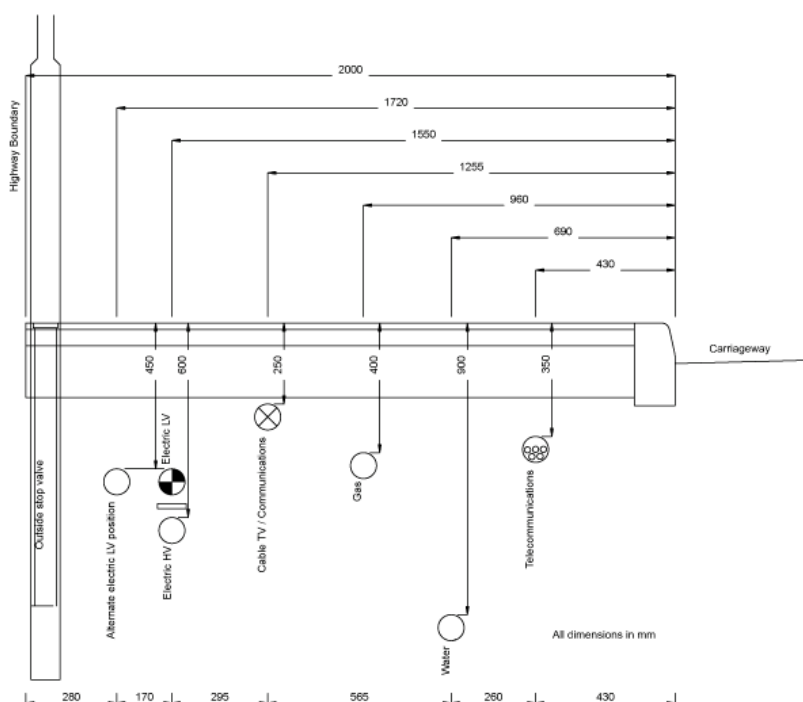

3.154 Where developments include central recycling points, you should site these also in line with the above guidance.

Section DG12: Drainage

3.155 We have a duty to make sure that developments include satisfactory arrangements for draining the [adoptable highway](#). This should normally be achieved by one of the following methods.

- All highway water should be drained direct into a piped system adopted by a water company. Please see [Part 7](#) for contact details. This is the method we prefer.
- If the above method is not possible, water should be drained by a piped highway drainage system (minimum pipe size 225mm) running to an out-fall adopted by a water company or an out-fall to a ditch or watercourse agreed by the [Environment Agency](#). We will normally adopt a piped highway-drainage system like this where we are adopting the road.

All highway drains should be located within land that we are adopting. Only in exceptional circumstances will we permit them in land that is to remain private. You must cover any adoptable highway drain outside the limits of the adoptable highway by an easement agreement. This should be in place before, or be a condition of, the Section 38 or 278 agreement.

3.156 We will consider alternative highway-drainage systems, including SUDS, flow attenuation (reduction) or retention systems (including oversized pipes) and so on, on a site-by-site basis. Where there are valid reasons for providing systems like these, and where they would present us with extra maintenance liability over a piped system, we will

The 6Cs Design Guide

require you to pay [commuted sums](#). Please see [Part 4, Section MC18](#) for further details on our commuted sums policy.

3.157 We will not adopt a road unless its associated drainage is to be adopted either by a water company or by us.

3.158 We will not normally accept drainage of other non-adopted areas into any highway system. In general, the drainage of most other areas of a development are matters for water companies. You should normally design these drainage systems in line with the water companies' specifications and requirements (which you may treat as complementary to this document) and they should be adopted by them.

3.159 Please refer to [Part 4 Section MC8](#) for more details on highway drainage design and to [Part 4 Section MC18](#) for more details on commuted sums.



Section DG13: Landscaping

3.160 Soft or hard landscaping within highway areas can be as important in determining the character of the development and integrating it into its surroundings as landscaping elsewhere within the site. You should not underestimate how important it is to create an attractive environment. Planning authorities are unlikely to favour developments that lack quality design and layout.

3.161 Areas we are prepared to [adopt](#) as highway should be concentrated into larger areas, to provide economies of scale and to avoid small or remote areas which are difficult to maintain. Small and remote areas can actually result in the very opposite of what is intended of creating an attractive and well-cared-for environment.

3.162 You should prepare landscaping proposals at the pre-planning application stage so we can consider their suitability in good time and so the utility providers (for example, gas, water, cable TV) can be consulted over the proposals. We must approve the landscaping proposals within the development whether or not they form part of a landscaping scheme that you have submitted to the planning authority for approval. (Please see [Part 4](#) for further information).

3.163 While planting and trees can enhance the street scene, you must take care when you are selecting and positioning trees, shrubs and so on to make sure that building frontages and parking areas can still enjoy good natural observation from areas of potential activity such as roads and footways. Where trees outside of the highway boundary are planted within close vicinity of the highway boundary, root deflectors or root protection barriers may need to be considered.

3.164 We will require the payment of a [commuted sum](#) for any proposed planting, trees, shrubs and so on that we are prepared to [adopt](#). Please see [Part 4, Section MC18](#) for further details on our commuted sums policy.

The 6Cs Design Guide

3.165 Public open spaces, including amenity open spaces and children's play areas, will normally be adopted by the district, town or parish council. We will normally only consider adopting an area of open space that:

- is next to but not essential part of the adoptable highway;
- is not going to be adopted as public open space by the district, borough or parish council;
- cannot be designed out; and
- may not be safely and satisfactorily maintained if it becomes part of the adjacent property.

You will need to pay us a [commuted sum](#) for any open space we adopt.



Section DG14: Vehicle parking and making provision for service vehicles

- [Off-street parking standards](#)
- [Disabled parking](#)
- [Standards for servicing provision](#)
- [General design principles for off-street parking](#)
- [On-street parking](#)

3.166 This section sets out off-street parking standards and gives guidance on the design of parking in residential and employment and commercial developments. It covers vehicle parking, provision for service vehicles, motorcycle parking and cycle parking.

3.167 We will be considering parking standards further with District, Borough and City Councils as they prepare their development plans. In particular:

- in urban areas we will be seeking to identify more specific areas where the various parking standards will normally be applied; and
- we will be considering appropriate standards for rural areas.

We will review the standards in the light of any further national guidance or research. The Chartered Institution of Highways and Transportation (CIHT) and the Institute of Highway Engineers (IHE) have published (April 2012) a guidance note on residential parking. This can be viewed [here](#). In the meantime, the normal starting point for determining off-street parking provision is set out in the following paragraphs and tables. Where you are in doubt about which type of area a development falls into, you should discuss this with us and the planning authority at the earliest opportunity.

The 6Cs Design Guide

3.168 Parking provision should be considered in relation to any transport assessment and travel plan associated with a development proposal. Please refer to [Section DG17](#).

3.169 Where you do not provide suitable parking arrangements within a development, we may refuse to [adopt](#) the development roads.

Off-street parking standards (excluding residential see [3.168](#))

3.170 The normal maximum vehicular parking standards shown in Table DG11 below are taken from [RPG8](#). For developments below the threshold, we will continue to apply the standards contained in the previous guidance document [Highway Requirements for Development \(HRfD\)](#) for the time being as the normal maximum standards. In certain circumstances, for example, where there are road safety or amenity issues that cannot be satisfactorily resolved, we may require a higher level of parking provision.

Note: These standards will normally be applied in areas for which Leicestershire County Council is the highway authority. Other authorities have their own separate standards which will normally be allied for developments.

Leicester City Parking standards can be found at www.leicester.gov.uk

Nottinghamshire County Council parking standards can be found at www.nottinghamshire.gov.uk/travelling/parking/parkingpolicy/

Table DG11: Normal maximum parking standards ^(a) ^(b)

Use ^(c)	Normal maximum parking standard based on one space for every square Metre (m ²) of gross floorspace unless otherwise stated	Threshold for applying the standard (gross floorspace) ^(d)
Food retail	One space for every 14m ²	1000m ²
Non food retail	One space for every 20m ²	1000m ²
B1 offices	(see note e) Urban town centre or edge of centre; One space for every 60m ² Rural town centre or edge of centre; One space for every 40m ² Rest of rural town; One space for every 30m ² Out of any town; One space for every 30m ²	2500m ²
B1 Non-office and B2 General industry ^(f)	(see note e) Urban town centre or edge of centre; One space for every 130m ² Rest of urban town; One space for every 80m ²	2500m ²

The 6Cs Design Guide

	<p>Rural town centre or edge of centre; One space for every 90m²</p> <p>Rest of rural town; One space for every 65m²</p> <p>Out of any town; One space for every 55m²</p>	
B8 Warehousing	<p>(see note e)</p> <p>Urban town centre or edge of centre; One space for every 300m²</p> <p>Rest of urban town; One space for every 180m²</p> <p>Rural town centre/edge of centre; One space for every 200m²</p> <p>Rest of rural town; One space for every 150m²</p> <p>Out of any town; One space for every 120m²</p>	2500m ²
Cinemas and conference facilities	One space for every five seats	1000m ²
D2 (other than cinemas, conference facilities and stadia)	One space for every 22m ²	1000m ²
Higher and further education	One space for every two staff plus one space for every 15 students ^(g)	2500m ²
Stadia	One space for every 15 seats ^(h)	1500 seats

(a) You should provide parking for people with disabilities as in [paragraph 3.177](#) onwards.

(b) Please refer to [paragraph 3.181](#) onwards for details on sizes of parking spaces and the design of car-park layouts.

(c) Please see [paragraph 3.171](#) onwards for standards for residential parking.

(d) Please see [paragraph 3.170](#) for developments below the thresholds shown or otherwise not listed.

(e) [RPG8](#) defines Leicestershire urban towns as Oadby, Wigston, Hinckley, Earl Shilton, Barwell, Burbage, Loughborough and Shepshed. We will work with district councils to establish where within and around these towns the various levels of parking standards will specifically apply. It will also work with the district councils to agree standards for rural towns, which are not defined in RPG8.

(f) We will recommend that restrictions are imposed to prevent changes to B1 office use where no allowance has been made for the higher parking levels associated with offices.

The 6Cs Design Guide

(g) The figure for students relates to the total number of students rather than full-time equivalent figures.

(h) You should provide parking spaces for coaches in addition to the above, to be agreed for each specific site. Coach parking should be designed and managed so that it will not be used for car parking.

3.171 In Leicestershire, where no parking standard is given for a particular development (either in [Table DG11](#) or in our [previous document HRfD](#) or in [paragraph 3.174](#) for residential developments), we will consider the provision required taking certain factors into account including:

- the control of on-street parking in the area;
- the development's exact nature and likely use;
- its geographical location;
- the standard of the surrounding road network and the traffic and parking conditions on it; and
- how accessible the development is using other methods of transport, including public transport, walking or cycling.

Note: Leicester City Council and Nottinghamshire County Council have their own [separate standards](#) which it will normally apply to developments in their areas where Leicestershire County Council is the highway authority.

3.172 The Department for Communities and Local Government (DCLG) has recently published a [research paper on residential car parking](#) (Appendix M). It sets out a method for calculating total demand for parking for a proposed housing development based on a number of factors including:

- car ownership levels;
- size and type of housing (that is owner-occupied, rented and so on); and
- whether the parking spaces are to be allocated to particular houses or unallocated.

Depending on the scale of your proposed development, we will normally expect you to apply this method.

3.173 Developments of 1 to 5 houses: You have the choice of either applying the following standards or using the DCLG paper method referred to in paragraph 3.168. (Please see [paragraph 3.174](#) if you intend to use the DCLG method.)

- One space for each dwelling:
 - where car ownership may be low, such as town centres and other locations where services can easily be reached by walking, cycling or public transport.
- Two spaces for each dwelling:
 - urban locations with poor access to services and poor public transport services;
 - three-bedroom dwellings in suburban or rural areas; and
 - other locations where car ownership is likely to be higher than locations that are better served by public transport.
- Three spaces for each dwelling:
 - four-bedroom dwellings in suburban or rural areas; or

The 6Cs Design Guide

- other locations where car ownership is likely to be higher than locations that are better served by public transport.

3.174 **Developments over 5 dwellings:** We will normally expect you to apply the DCLG paper method.

3.175 Where you are using the DCLG paper method, we will normally expect you to provide your initial estimate of parking demand before you submit a planning application. We will also expect you to supply details of how that demand will be met, that is the mix of on-plot parking*, on-street parking and parking courts**. When you calculate parking demand, you should remember that the counties are both geographically and economically diverse, which can influence levels of car-ownership. They range from rural areas to the more densely-developed suburbs.

Notes:

*We will normally only consider counting garages as parking spaces where they meet the dimension requirements set out in paragraph 3.221.

**Experience with recent developments is that many residents make little or no use of parking courts. This results in wasteful use of land as well as on-street parking which the road layout has not been designed to accommodate. Where you are proposing a development that includes communal parking courts*, we would only consider a lower level of parking provision on the site where:

- parking courts are designed to take account of the principles set out in [paragraph 3.182](#); and
- there would be no conflicts with the objectives of our '[highways development control policy](#)'

*(*Note: A communal court is a parking area available for general use by residents and visitors in, for example, a development of flats. This guidance does not apply to a parking court allocated to an individual property or allocated parking spaces grouped together to serve several properties, such as rear parking courts that are becoming increasingly common in new developments.)*

The 6Cs Design Guide

Figure DG15a May be prepared to consider a lower level parking provision

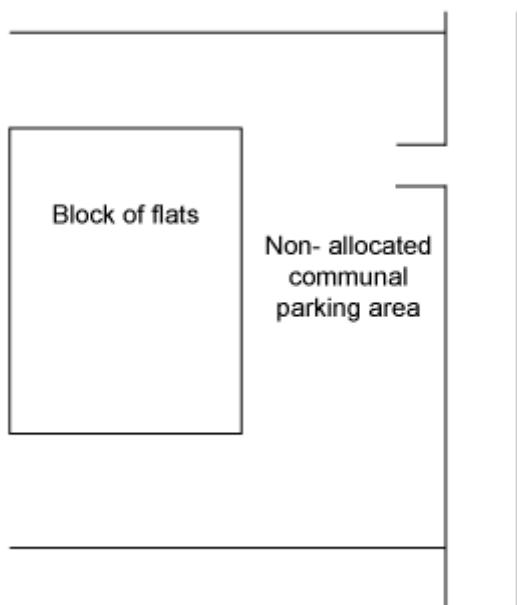
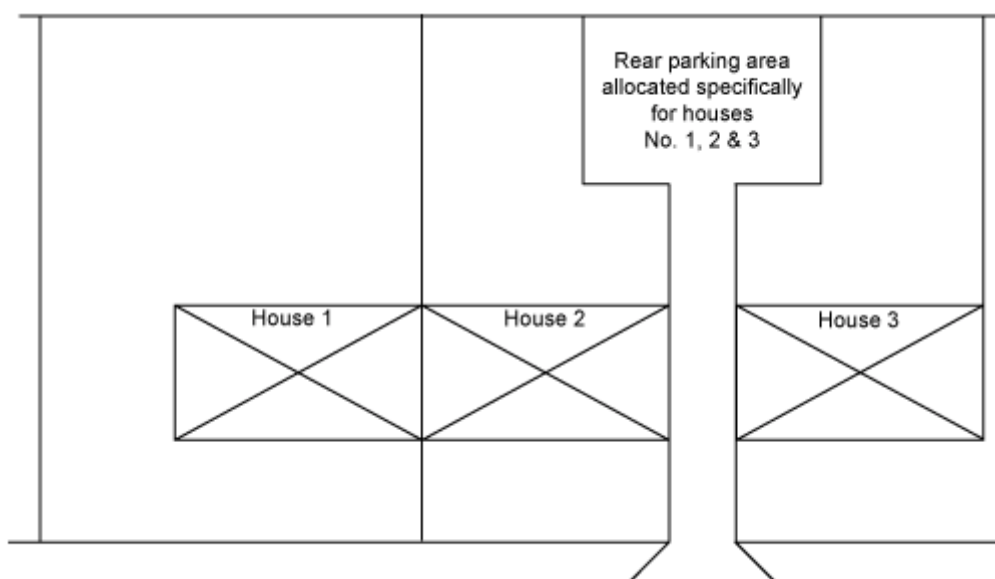

Figure DG15b Reduced parking provision would not normally be considered



3.176 For details of garage design and layout please refer to [Section DG18, paragraph 3.222](#) onwards. Garages will not normally be counted as a parking space for the purpose of calculating parking provision, unless:

- the garage meets the minimum dimensions given in [Section DG18](#);
- planning conditions are imposed to control use of the garage; or
- restrictions are placed on converting the garage to a room that can be lived in.

If a dwelling has no separate [parking for cycles](#), it may affect whether we consider that the garage should be counted towards parking provision.

The 6Cs Design Guide

3.177 Where satisfactory levels of off-street parking are not provided, measures may be required in line with [paragraph 3.192](#) onwards to minimise the risk of problems caused by on-street parking, including providing wider roads.

Disabled parking

3.178 Many disabled people rely on the car for getting about. Whether they drive themselves or travel as a passenger, reaching their destination with ease is almost always determined by where the car can be parked. So it is very important that proper parking provision is made in new developments.

3.179 For all non-residential developments, you should provide disabled parking to the minimum standards shown in Table DG12. This provision should be in addition to general parking provision. Parking for disabled people should be located as close as possible to the main entrance of a building.

Table DG12: Minimum provision for disabled parking spaces ^(a)

Car park used for	Car park size	
	Up to 200 spaces	Over 200 spaces
Employees and visitors to business premises	Individual bays for each disabled employee plus two bays or 5% of total parking spaces whichever is greater	Six bays plus 2% of total parking spaces
Shopping, recreation and leisure	Three bays or 6% of total parking spaces whichever is greater	Four bays plus 4% of total parking spaces
Schools and higher and further education	At least one bay regardless of car park size	At least one bay regardless of car park size

(a) Please refer to [paragraph 3.181](#) onwards for details on sizes of parking spaces and design of car park layouts.

3.180 You should monitor how reserved bays are used to make sure:

- other motorists do not abuse their use; and
- the number of spaces continues to meet the full demand.

The 6Cs Design Guide

Standards for servicing provision

3.181 Servicing provision for various types of development are given in [Table DG13](#).

Table DG13: Minimum servicing provision ^(a)

Use class	Description of land use	Normal servicing provision
A1	Shops	Stores above 5000m ² One goods bay space for every 1000m ² ; Stores between 3000m ² to 5000m ² One goods bay space for every 750m ² ; Stores between 300m ² to 3000m ² You must make provision within the site for service and delivery vehicles to be loaded and unloaded clear of the highway.
A3, A4	Restaurants, cafes and drinking establishments	You must make provision within the site for service and delivery vehicles to be loaded and unloaded clear of the highway.
B1	Light industry, Research and development	One lorry space for every 500m ²
B2	General industrial	One lorry space for every 400m ²
B8	Storage and distribution	One lorry space for every 400m ²

(a) Please refer to [paragraph 3.181](#) onwards for details on sizes of parking spaces and design of car-park layouts.

General design principles for off-street parking

3.182 **Residential:** Off-street parking areas should be close to the dwellings that they serve to make sure that they are fully used. This will minimise the possibility of on-street parking problems. Separate parking areas which are remote from some or all of the properties that they serve, and which cannot be easily observed, can result in on-street parking problems and also crime, anti-social behaviour and maintenance problems which discourage their use and affects the overall quality and appearance of a development.

3.183 You should involve us, the planning authority and the relevant police force Architectural Liaison Officer (ALO) in finding parking solutions. But, as general guidance to avoid potential problems, remote parking areas should normally:

- be located near to the main entrances to the properties that it serves, with as short and direct a walking route as is possible between the parking court and the property;
- be secure, including enjoying good natural observation from neighbouring buildings and not be surrounded by blank walls or close-boarded fences and so on;
- be well lit;
- limit planting to low ground cover only;

The 6Cs Design Guide

- be suitably surfaced and drained, and you will be expected to provide clear details of future maintenance responsibilities (we will not normally [adopt](#) off-street parking areas);
- have clearly-designated spaces for individual dwellings; and
- have open pedestrian routes to the parking area where possible. Where not, they should be designed in line with the guidance on separate routes at [paragraphs 3.111](#) onwards of this document.

The location and overall design should encourage maximum use of the parking areas in order to minimise the risk of on-street parking problems.

3.184 You should consider the needs of people with mobility and visual impairments both in the layout of the parking area and any routes between it and the associated dwellings.

3.185 Industrial and commercial and other large-use car parks (for example for leisure and retail): We will not normally [adopt](#) off-street parking areas in these developments. However, your design should do the following.

- Make sure there is free flow of traffic entering and leaving the car park to minimise the likelihood of tailbacks causing safety problems and delays on the surrounding road network. This may require one-way systems with control ramps or flaps at entrances and exits and appropriate signing in larger car parks.
- Provide safe pedestrian and cycle routes across the car park to building entrances, following natural paths wherever possible. In larger car parks you should consider segregated routes with raised crossing points on main vehicle routes. Any routes should be in the open wherever possible. Where not, you should design them in line with the guidance on separate routes at [paragraphs 3.111](#) onwards of this document.

3.186 You should also design such off-street parking areas to:

- minimise the number of entry and exit points to the public highway;
- provide visibility splays appropriate to likely vehicle speeds and 'road' widths and corner radii appropriate to likely vehicle sizes and manoeuvres;
- be well lit;
- be well landscaped, although any planting should be kept to low ground cover only;
- be suitably surfaced and drained;
- take into account and complement relevant measures included in any travel plan associated with the development, for example, car-share spaces located closest to the building entrance; and
- make appropriate provision for those with mobility and visual impairments in line with [Traffic Advisory Leaflet 5/95](#). This includes locating parking spaces in larger car parks as follows:

Disability	Distance (metres)
Visually impaired	150
Wheelchair users	150
Ambulatory without walking aid	100
Stick users	50

The 6Cs Design Guide

3.187 For more information about designing and locating disabled parking spaces, please consult [Traffic Advisory Leaflet 5/95](#) Parking for Disabled and [Building Regulations Part M \(2004 Edition\)](#), particularly with regard to the design of any payment or ticket machines or car park access-control systems.

3.188 Minimum parking space sizes and aisle widths are shown in Figure DG16.

Figure DG16 Size and layout of parking spaces.

Minimum parking spaces 2.4m x 5.5m add 0.5m if bounded by a wall, fence, hedge, line of trees or other similar obstruction on 1 side, 1m if bounded on both sides.

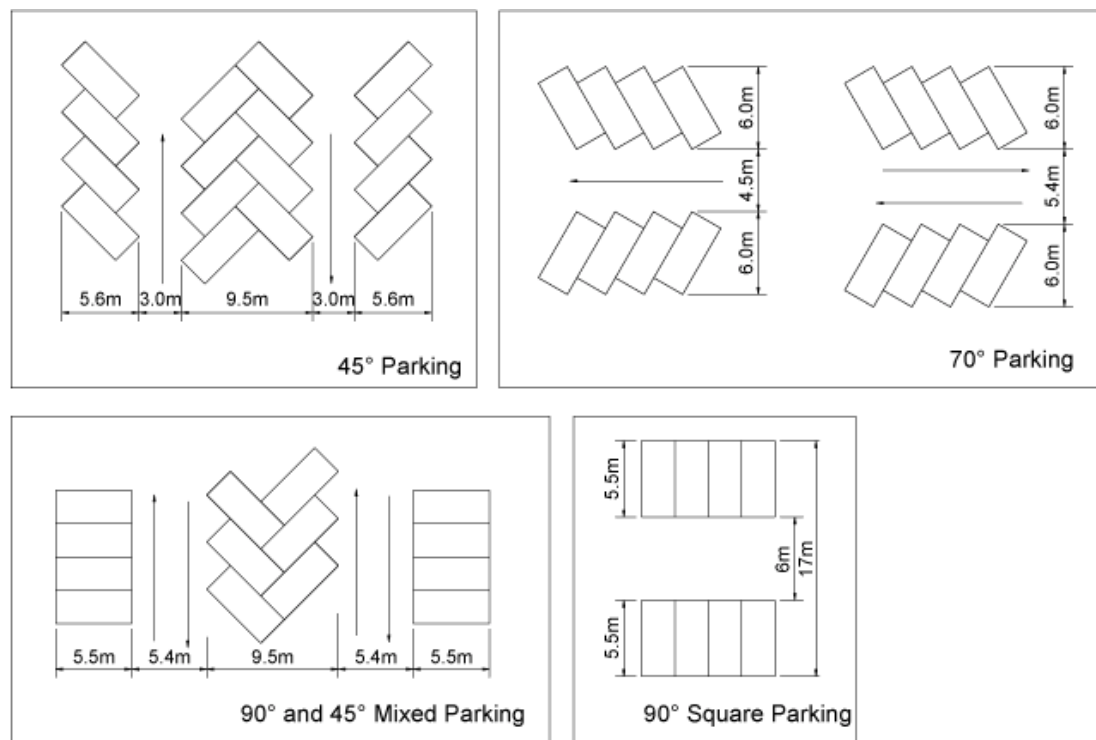

Examples of typical parking layouts

The 6Cs Design Guide

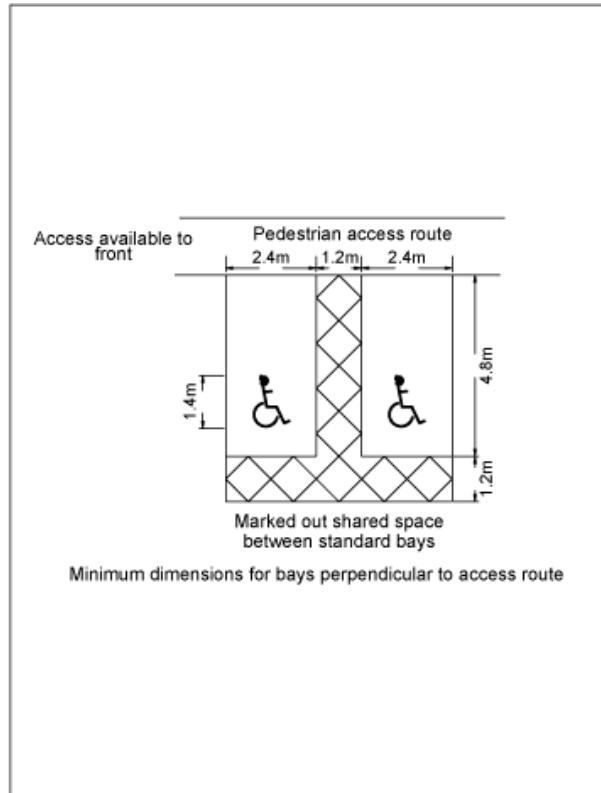
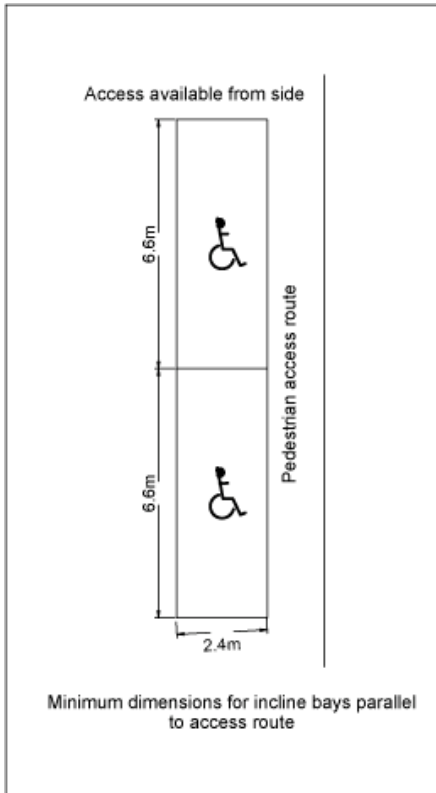

Disabled parking spaces layout

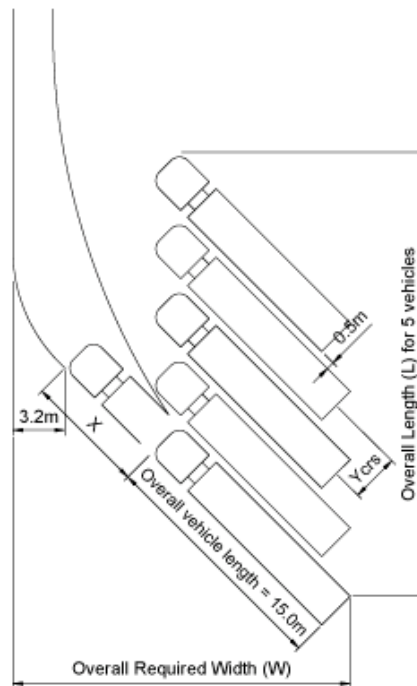
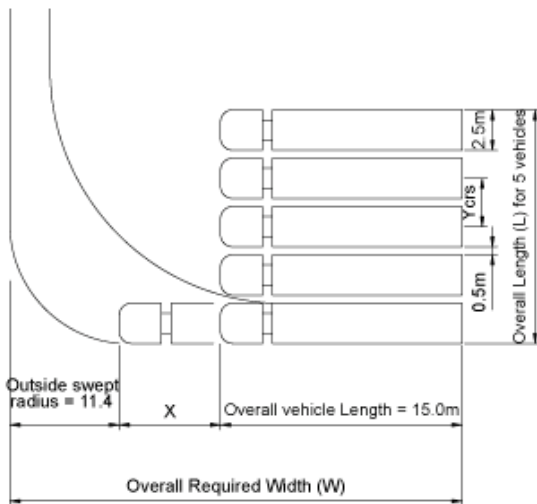

Notes:
X = Draw forward before turning distance

Lorry parking and loading bays - head-on and Lorry parking and loading bays - 45° for largest vehicles

The 6Cs Design Guide

X draw forward	Y centres	W o/a width	L o/a length for 5	X draw forward	Y centres	W o/a width	L o/a length for 5
1	5.0	27.4	22.5	4	4.8	18.4	39.5
2	4.4	28.4	20.1	5	4.5	19.1	37.8
3	4.0	29.4	18.5	6	4.2	19.8	36.1
4	3.7	30.4	17.3	7	3.9	20.5	34.4
5	3.4	31.4	16.1	8	3.6	21.2	32.7
6	3.0	32.4	14.5	9	3.4	21.9	31.6
				10	3.2	22.6	30.5
				11	3.1	23.4	29.9
				12	3.0	24.1	29.3

On-street parking

3.189 Research we have carried out has shown that a main concern of Leicestershire residents is on-street parking. National research, including that by the New Homes Marketing Board and Halifax PLC, also highlights on-street parking as a real problem. Where on-street parking provision is poorly designed, it can:

- impair road safety
- obstruct access for vehicles, including for service vehicles, the emergency services and buses;
- obstruct footways and be a hazard to cyclists and pedestrians, including those with mobility or visual impairments;
- make a development look cluttered and unattractive;
- be a source of crime; and
- cause friction between occupiers where private accesses are blocked.

Figure DG17 Examples of on-street parking problems



Parking in turning head and obstructing access to private drives

'Unsightly' parking obstructing a junction

The 6Cs Design Guide



Parking obstructing a footway - hazard to pedestrians

Access for service vehicle restricted by parking



Parking causing vehicles to cross on to wrong side of the road

3.190 So, in the interests of the safety of all road users, including pedestrians and cyclists, and of maintaining efficient flow of traffic, we will look for developments that include well-designed parking layouts (on-street and off-street) that minimise the likelihood of on-street parking problems. For parallel parking to a road, each vehicle will normally need an area of about 2m wide x 6m long. For echelon (wedge shaped) parking and perpendicular (end on to the road) parking, individual bays should normally be indicated or marked. Bays should normally be about 2.4m wide and a minimum 4.8m long and they should be arranged so that drivers are encouraged to reverse into them. Figure DG18a shows some suggested on-street parking arrangements, and also sets- out how to calculate the necessary width needed to access echelon parking. A guidance note on residential parking, produced by the Chartered Institution of Highways & Transportation (CIHT) and Institute of Highway Engineers (IHE), can be viewed at: <http://www.ciht.org.uk/en/publications/standards--advice.cfm>.

3.191 Where it appears that on-street parking could cause problems, we will ask you for computerised tracking assessments of appropriate vehicle paths (these are likely to include refuse lorries, pantechincons, fire tenders and buses if the development is to be served by public transport). Where the assessment demonstrates that it is necessary to provide extra width to accommodate on-street parking, you should normally achieve this either by:

- providing parking bays as illustrated below (bays should not be designated to particular properties); or
- increasing the overall carriageway width. We can accept localised width variations - it is not necessary for a road to have a constant width and parallel kerb lines throughout.

The 6Cs Design Guide

Figure DG18 Good examples of on-street parking bays



Figure DG18a Suggested on-street parking bays, parallel and perpendicular parking (top) and widening of carriageway to create on-street spaces (bottom). This Figure is based upon Figures 8.18 and 8.19 and paragraph 8.3.5.1 of the Manual for Streets documents. The Manual for Streets is copyright of the Department for Transport and Department of Communities and Local Government

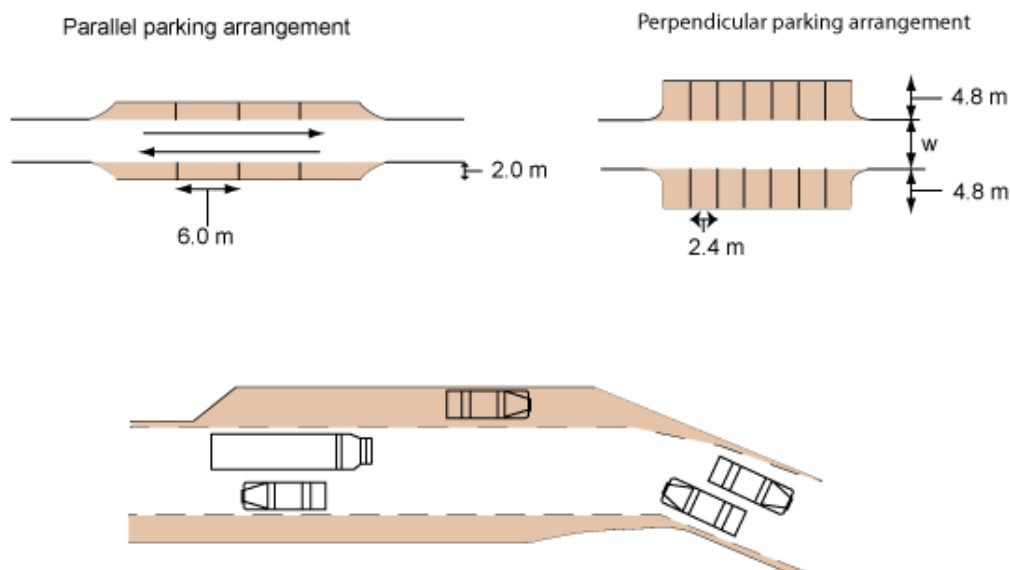

3.192 Where we [adopt](#) additional areas to accommodate on-street parking, you will have to pay [commuted sums](#) to cover future maintenance. Please see [Part 4, Section MC18](#) for further details on our commuted sums policy.

3.193 You may also be required to provide measures to prevent parking in unsuitable areas and to make sure parking bays are used correctly. This might include providing bollards, fencing and landscaping. These should be integrated with the design of the overall development proposal and may also require the payment of [commuted sums](#) to cover their future maintenance. You may also need to adjust proposed building and plot layouts to

The 6Cs Design Guide

avoid locating pedestrian accesses at points where they may cause problems if someone left their vehicle parked on-street while in the building.

3.194 In certain circumstances, traffic regulation orders may be needed to control on-street parking, including waiting restrictions and residents' parking schemes either within the development or on the surrounding highway network. Where this is so, you will normally be required to pay all costs associated with making the orders. (Please also see [Section DG9](#).)



Section DG15: Parking for motor cycles

3.195 Motorcycles and mopeds can provide an alternative to the private car for certain trips. There is a growth in the popularity of motorcycles and mopeds both for leisure and as a means of transport where public transport is limited and walking or cycling is unrealistic. If people switched from walking, cycling and public transport to riding motorcycles and mopeds, the environmental benefits would be less clear.

3.196 The parking standard for motorcycles and mopeds is:

- one space, plus an additional space for every 10 car parking spaces.

3.197 Parking spaces should normally be:

- 2.5m x 1.5m with a 1m space between each bike.

3.198 The design of the parking area should allow motor cycles and mopeds to be secured to the ground while parked.

3.199 Parking provision should be considered in relation to any travel plan associated with a development proposal. Please refer to [Section DG17](#).



Section DG16: Parking for cycles

3.200 As the [Manual for Streets](#) emphasizes, providing well-located, safe and secure cycle parking is a major factor in encouraging people to cycle as an alternative to using the

The 6Cs Design Guide

private car. So, the parking standards in Table DG14 below are the normal minimum requirements.

Note: Leicester City's parking standards can be found at www.leicester.gov.uk/your-council-services/ep/planning/plansandpolicy/localplan/writtenstatement/appendicescllp

3.201 Where it is not possible to provide cycle parking spaces on site, you will normally be expected to make a financial contribution towards providing public facilities where this provision is possible.

Table DG14: Minimum provision for cycle parking ^(a)

Use class	Description of land use	Provision
A1 and A3	Shops and restaurants, pubs and clubs	One space per 500m ² up to 4000m ² gross floor area (GFA) for staff and operational use. Parking to be secure and under cover. One space for every 1000m ² GFA for customer use to be in the form as shown in Figure DG19 . Parking to be located in a prominent and convenient location.
A2 and B1	Financial and professional services, and research and development and offices	One space per 400m ² GFA for staff and operational use. Parking to be secure and under cover. Customer parking to be assessed on a site-by-site basis.
B2 to B8	General industry and storage and distribution	One space per 400m ² GFA. Parking to be secure and under cover.
C3	Dwelling houses ^(b) ^(c)	For developments with common facilities, such as flats, one space for every five dwellings. Parking to be under cover and secure. Where spaces are allocated, there should be one space for each dwelling.
D1 and D2	Non-residential institutions, assembly and leisure	Staff parking to be assessed on a site-by-site basis. Sufficient cycle racks to accommodate five percent of the maximum number of visitors expected to use the facility at any one time. Racks to be in the form as shown in Figure DG19 and to be located in a prominent and convenient location.

(a) Developments or circumstances not covered in the table will be assessed on a site-by-site basis.

(b) If cycle parking is not provided for residential developments, it may affect the way we consider the use of garages, i.e. whether they should count towards parking provision.

(c) If cycle parking is provided on upper floors, such as in flats, lifts that can take bikes should be provided.

3.202 All cycle parking must:

- be secure and normally with weather protection;
- be conveniently located at entrances to buildings;
- enjoy good natural observation;

The 6Cs Design Guide

- be well lit; and
- be located so it does not obstruct pedestrian and cycle routes.

3.203 Normally you should provide Sheffield stands as illustrated in Figure DG19 below. Stands that grip only the front wheel do not provide adequate support or security. When placed 1m apart and 0.5m from the wall, Sheffield stands can accommodate two bicycles. Where more than two stands are required, you may need to provide a 'toast rack' facility.

Figure DG19 Sheffield stand - inset 'toast rack' type. Sheffield stands can accommodate two cycles provided that stands are placed 1m apart and at least 500mm from any wall.

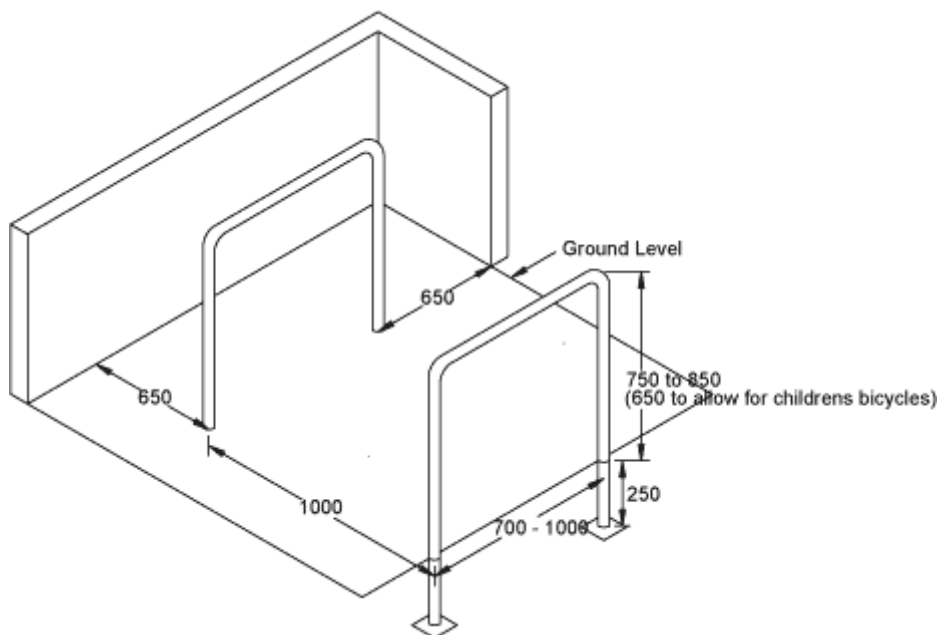

3.204 Parking provision should be considered in relation to any travel plan associated with a development proposal. Please refer to Section DG17.

3.205 Please refer to [Traffic Advisory Leaflet 5/02](#) for further information on cycle parking.



Section DG17: Considering parking provision together with transport assessments and travel plans

3.206 You should not consider vehicle, motor cycle or cycle parking provision in isolation from travel plans. The level and design of on-site parking and any proposed travel plan measures should reflect and complement each other. The 6CsDG board is currently developing its own guidance on preparing travel plans. In the meantime, you can find some interim guidance in the [Transport Assessment Guidelines](#) in Part 7, appendix C.

The 6Cs Design Guide

3.207 For employment developments and other developments where travel plans are required, we will normally expect the development to include complementary facilities for motorcyclist and cyclists, for example, secure lockers (for storing clothes, and so on), showers and changing rooms.



Section DG18: Residential developments served by private drives and areas

- [Principles](#)
- [General geometry for site access to the external road network](#)
- [General layout of a private residential development](#)
- [Construction standards for private drives](#)
- [Garages and gated accesses](#)

3.208 This section provides design guidance on private drives and areas. For guidance on the [Advance Payments Code \(APC\)](#), please see [Part 5, Section ANR2](#).

Principles

3.209 For developments of more than five dwellings, we will encourage developers to create, whenever possible, 'road' layouts that are to an [adoptable](#) standard and that will be offered for adoption. We will not normally adopt developments of five or less dwellings.

3.210 For developments of six or more dwellings, you should remember the implications both for yourself and house purchasers if we do not adopt the roads, for example:

- future maintenance liabilities;
- public liabilities
- street cleansing;
- lack of specific pedestrian facilities;
- lack of or poor standard of lighting, drainage and so on;
- we have no powers under the Highways Act; and
- the police have no powers to remove obstructions.

Poorly-maintained private areas can also detract from the quality and appearance of a development.

3.211 Private developments should normally be in the form of a cul-de-sac. You should try to avoid private 'through' routes as they are more likely to be used by the general public, possibly adding to the liabilities and future problems for residents.

3.212 For private developments of six dwellings or more, we will normally serve a notice on you with an assessment of the cost of the proposed roadworks under the Advance Payment Code (APC), to protect frontagers' interests. The cost of this will reflect the cost of the proposed street works and you should construct the works to an appropriate standard.

The 6Cs Design Guide

However, because APCs have been served and money has been paid or retained, we are not indicating any future intention to [adopt](#) and maintain the street works at public expense. Please see [Part 5, Section ANR2](#) for more information.

3.213 If you clearly indicate that the development roads are to be private, we may also require:

- you to deposit a map with us under Section 31 (6) of the [Highways Act 1980](#) identifying the roads which are to remain private (and any to be adopted too as appropriate);
- you to erect road signs indicating that the roads are unadopted and to maintain the signs for as long as the roads remain unadopted, all at your expense;
- evidence that you have made clear to potential purchasers of the dwellings on unadopted roads what the status of the road will mean to them in practice; and
- evidence that you have secured future maintenance of the roads, for example, a unilateral undertaking by you under Section 106 of the [Town and Country Planning Act](#) to set up a maintenance company;
- you to indemnify us against future petitioning by residents to [adopt](#) their road under Section 37 of the [Highways Act 1980](#), where the road joins together two adopted highways*; and
- the boundary between the private road and the publicly-maintained highway to be clearly marked by a concrete edging, boundary posts or similar.

*Note: The indemnity should normally be a legal covenant placed on the properties to prevent petitioning. We must approve the wording of the covenant.

General geometry for site access to the external road network

3.214 **Note:** in all cases, the proposed development and its location must be acceptable to us in principle and highway safety must not be reduced.

On roads with a speed limit of 40mph or higher, or where vehicle speeds are more than 40mph:

- we will encourage a development to be served by a road with an adoptable layout and access designed in line with the appropriate section of the [Design Manual for Roads and Bridges](#); or
- where we accept that there is good reason why an adoptable layout cannot be achieved, the private drive and site access must be purpose-designed to a standard acceptable to us.

For all roads where the speed limit or recorded vehicle speeds is less than 40mph, even where you can demonstrate that you cannot achieve any form of adoptable layout or you do not want your development roads to be adopted (despite the implications in [paragraph 3.213](#) above), you must still design the site access point to make sure that it does not affect the safety and efficient functioning of the highway or otherwise affect road users. (It will normally need to be designed in accordance with the Manual for Streets 1 and 2 or other standard acceptable to us.) Please see [appendix E](#) (for additional information on private areas).

The 6Cs Design Guide

For private developments of six dwellings or more, we will normally serve a notice on you with an assessment of the cost of the proposed roadworks under the Advance Payments Code (APC), to protect frontagers' interests. Please see [Part 5, section ANR2](#) for more information.

3.215 You should provide the site access point in line with either Figure DG20 or Figure DG21, depending on the scale of the development. Also depending on the scale of the development, you will need to obtain our specific approval for the construction details of the access. The access will only be acceptable if you have a maintenance agreement planned or in place.

Figure DG20 Unadopted shared drive serving up to 25 dwellings

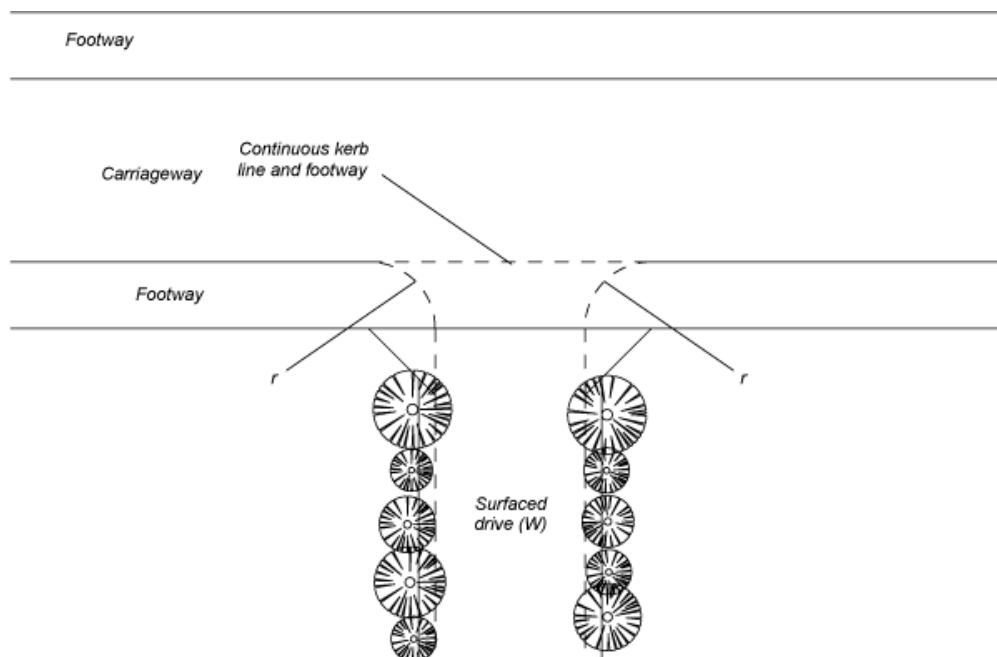

<p>Minimum effective width (a)</p>	<p>Single dwelling = 2.75m Two to five dwellings = 4.25m for a minimum distance of 5m behind the highway boundary. Six to 25 dwellings = 4.8m for a minimum distance of 5m behind the highway boundary^(a) (In all cases add 0.5m if bounded by a wall, fence, hedge, line of trees or other similar obstruction on one side, 1m if bounded on both sides. See also paragraph 3.219 about access for refuse collection and 3.220 about access for emergency vehicles.)</p>						
<p>Minimum drop crossing (b) Single dwelling 2 to 5</p>	<p>For lightly trafficked residential streets (c). For classified or highly trafficked streets (d)</p> <table border="0" style="width: 100%;"> <tbody> <tr> <td style="width: 50%;">4 dropped kerbs (3.7m)</td> <td style="width: 50%;">7 dropped kerbs (6.4m)</td> </tr> <tr> <td>6 dropped kerbs (5.5m)</td> <td>8 dropped kerbs (7.3m)</td> </tr> <tr> <td>8 dropped kerbs (7.3m)</td> <td>10 dropped kerbs (9.2m)</td> </tr> </tbody> </table>	4 dropped kerbs (3.7m)	7 dropped kerbs (6.4m)	6 dropped kerbs (5.5m)	8 dropped kerbs (7.3m)	8 dropped kerbs (7.3m)	10 dropped kerbs (9.2m)
4 dropped kerbs (3.7m)	7 dropped kerbs (6.4m)						
6 dropped kerbs (5.5m)	8 dropped kerbs (7.3m)						
8 dropped kerbs (7.3m)	10 dropped kerbs (9.2m)						

The 6Cs Design Guide

dwelling 6 to 25 dwellings	
Vehicle visibility splays	As in Table DG4, measured from a set back of 2.4m
Pedestrian visibility splays	2m by 2m both sides (no planting permitted)
Gradient	Preferably not greater than 1:20 for first 5m, (for 6-25 dwellings not greater than 1:30 for the first 10m), and should never exceed 1:12m
Surfacing	Bound material, for example, bituminous or concrete, or block paving for at least the first 5m

(a) If the driveway length is more than 25m, its minimum width should be 5m (plus any widening where bounded by walls) to enable access by refuse vehicles

(b) In certain circumstances, such as when parked vehicles restrict access, it will be necessary for a longer drop crossing to be provided. You may need to demonstrate an access is suitable by providing an appropriate vehicle swept path assessment.

(c) Typically this includes streets which primarily serve a place function and have 85th percentile speeds of 30mph or less and where encroachment on the opposite traffic lane when exiting the site is not considered to create a safety hazard.

(d) Typically this includes streets which primarily serve a movement function and have 85th percentile speeds of 40 mph or less and where encroachment on the opposite traffic lane when exiting the site should be minimised.

The 6Cs Design Guide

Figure DG21 Unadopted shared drive serving more than 25 dwellings

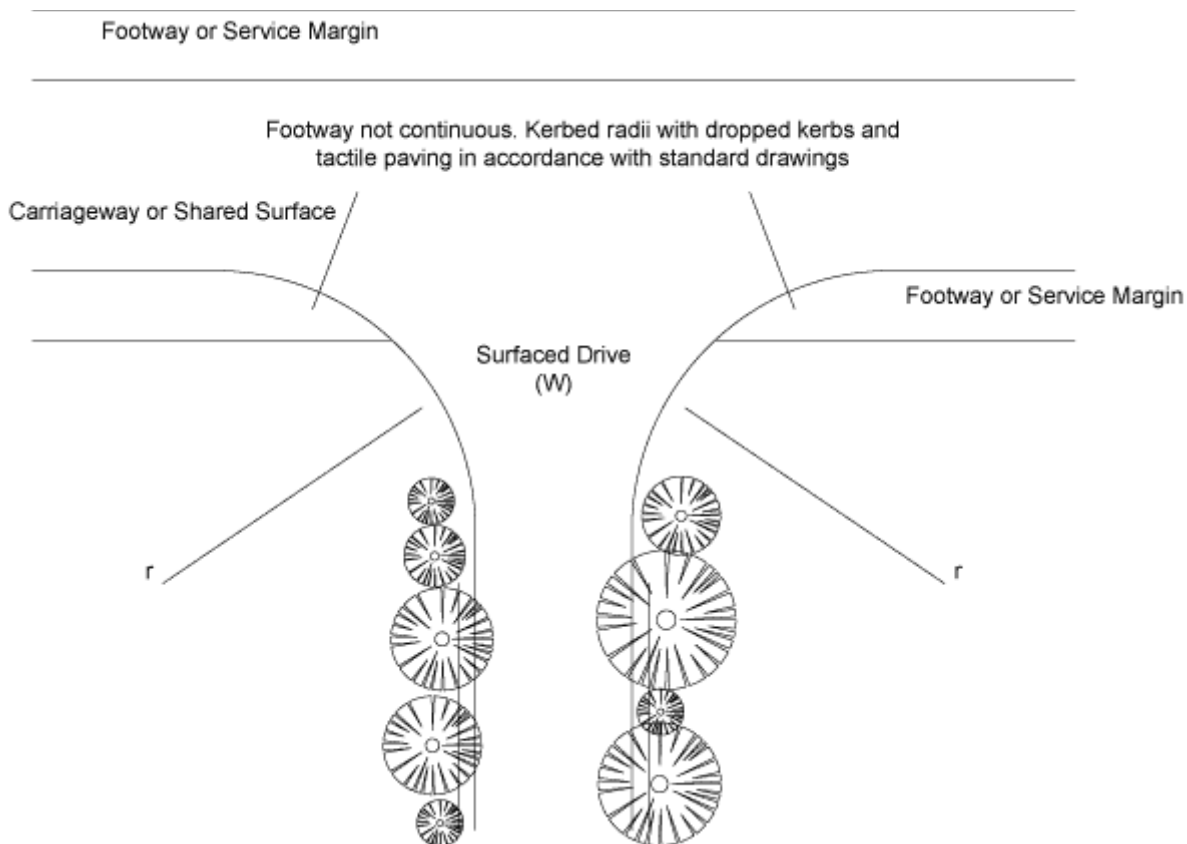

Access serving more than 25 dwellings	
Minimum effective width (w)	5.5m
	Add 0.5m if bounded by a wall on one side, 1m if bounded on both sides. See also paragraph 3.218 about access for refuse collection and 3.219 about access for emergency vehicles
Minimum kerbed radii (r)	6m
Vehicle visibility splays	As in Table DG4 , measured from a set back of 2.4m
Pedestrian visibility splays	2m by 2m both sides (no planting permitted)
Gradient	Preferably not greater than 1:20 for the first 5m, and should never exceed 1:12
Surfacing	Bound material, for example, bituminous or concrete, or block paving for at least the first 5m

The 6Cs Design Guide

3.216 On busy roads (generally with peak-hour traffic flows of more than 300 vehicles an hour), any gates should be set back at least 5m from the highway boundary and should open inwards only.

3.217 If you cannot achieve layouts to Figure DG20 and Figure DG21 we may recommend refusal of your proposals on grounds of safety or dangers to the public, as appropriate.

General layout of a private residential development

3.218 Even if a road is not to be [adopted](#) you should still seek to make sure that:

- your layouts are safe (both in terms of road safety and personal safety);
- your layouts are accessible to all likely users, including those with mobility impairments; and
- suitable long-term maintenance arrangements are in place.

Turning facilities will be required:

- where a proposed development takes access from a road with a speed limit above 40 mph; or
- for roads subject to speed limits less than 40 mph on any road carrying 300 vehicles per hour at its peak

Elsewhere, turning facilities will not normally be required unless road safety would be compromised.

Figure DG22 Private drive turning facilities - typical layout

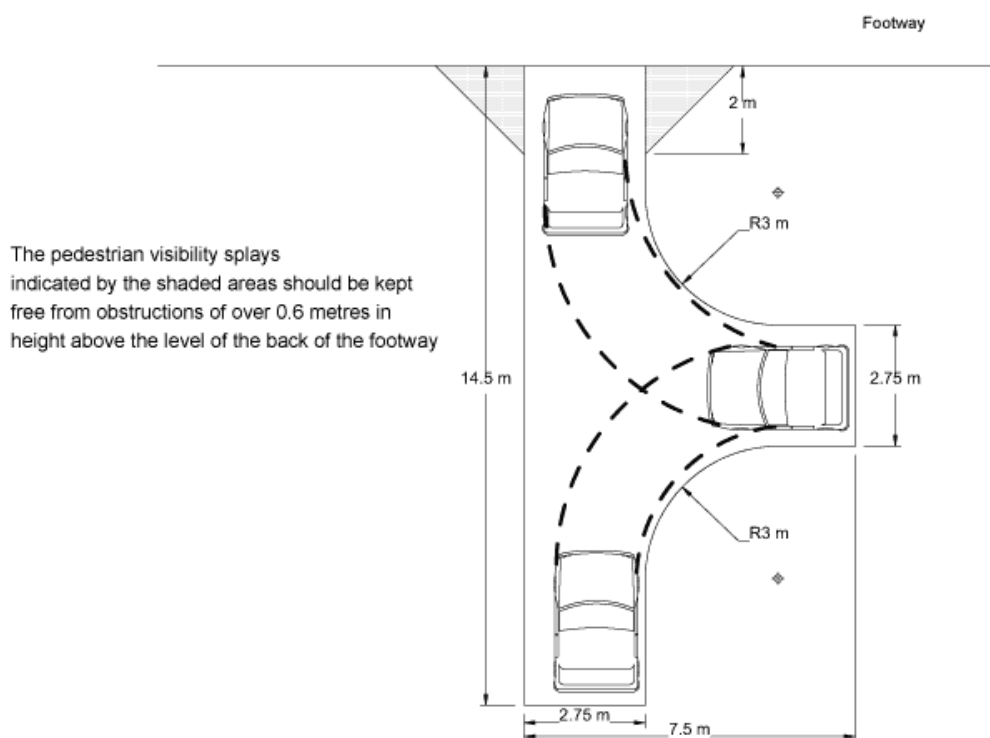

The 6Cs Design Guide

3.219 For long drives and accesses, you should consult [BS5906, 2005](#), which sets out maximum carry distances of 25m for refuse collection. Where this distance is exceeded, the British Standard recommends:

- a minimum drive width of 5m;
- providing turning heads within the site; and
- constructing the drive so it can carry a refuse vehicle.

The layout of the development should include measures to make sure that parked vehicles do not stop the use of any turning heads. Where 'wheelie bin' collection methods are used, you should consider providing a communal collection point within the site, close to the highway.

3.220 Where a development is situated more than 45m from the highway, you must cater for emergency vehicles by constructing the drive and any turning areas so they can cater for a commercial or service vehicle. The minimum width for access should be at least 3.7m (between kerbs) and fire vehicles should not have to reverse more than 20m. Your development must be in line with [British Standard BS5906, 2005](#) and [Building Regulations Approved Document B, Fire Safety 2006](#). You should also take into account the comments about parking in [paragraph 3.215](#).

3.221 You should also follow the general guidance contained in this part of the document on personal safety and designing-out crime, and you should ask the relevant police force 'Architectural Liaison Officer', the planning authority and us for guidance on proposals for specific sites. You should also make sure that you take into account the needs of people with impaired mobility.

Construction standards for private drives

3.222 The construction standards for drives serving up to and including 5 dwellings should normally be in accordance with that for footway vehicular and field accesses as shown in standard drawing SD/11/5A. [Standard Drawings](#). In other cases, they should normally be in line with Table DG15. (Contact us for permeable pavement design.)

Table DG15: Private road construction depths

		Road less than 25m long serving 6 to 25 dwellings	Road more than 25m long serving 6 to 25 dwellings	Road serving more than 25 dwellings
Bituminous	Surface course CGM	30mm	30mm	40mm
	Binder course DBM	85mm	60mm	60mm
	Base DBM	-	110mm	150
	Sub-base & Capping	270mm Type 1 GSB(a)	See Table MC4, Part 4	See Table MC4, Part 4
Block Paving	Blockwork	60mm	80mm	80mm
	Bedding sand	30mm	30mm	30mm

The 6Cs Design Guide

	(compacted)			
	Base DBM	90mm	110mm	150mm
	Sub-base & Capping	270mm Type 1 GSB(a)	See Table MC4 Part 4	See Table MC4 Part 4

Key

CGM = Close graded macadam

DBM = Dense bitumen macadam

Garages and gated accesses

3.223 On plot garages to individual properties should be located so:

- cars can park in front of the garage doors: and
- the garage doors can be opened while the car is on the drive (see Table DG16);

without the cars obstructing the highway, including any footway or turning facilities.

3.224 In the interests of urban design, garages should not dominate the street scene. Where an integral garage is proposed (that is, it is part of the house), you should hold early discussions with the planning authority on the design of the garage, the house and elevation of the property. The [Manual for Streets](#) documents suggest that keeping garages and parking areas level with the main building line can be beneficial to the townscape, but, a planning authority may require garages to be located behind houses and may not encourage integral garages.

Table DG16: Garage set-back distances

Garage door type	Minimum distance from highway boundary
Roller-shutter, sliding or inward opening	5.5m
'Up-and-over'	6.1m
Hinged, outward opening	6.5m

Where an access is to be gated, the gates should be set back 5m where they open inward and 6m where they open outwards. This is to ensure that the public highway (particularly areas used by pedestrians) is not obstructed if a vehicle is parked on the access in front of the gates.

3.225 Garages should preferably have the following minimum internal dimensions.

- Standard single = 6m x 3m, with minimum door width of 2.3m
- Use by disabled = 6m x 3.3m with minimum door width of 2.8m
- Double = 6m x 6m, with minimum door width of 4.2m.

If a dwelling has no separate [parking for cycles](#), it may affect whether we consider that the garage should be counted towards parking provision.

The 6Cs Design Guide



Section DG19: Employment and commercial developments served by private drives and areas

- [Principles](#)
- [General geometry for site access to the external road network](#)
- [General layout of a private industrial or commercial development](#)

3.226 This section provides design guidance on private drives and areas. Separate guidance is currently being prepared to cover procedures for serving and paying monies under the [Advance Payment Code](#).

Principles

3.227 For multiple-building, multiple-occupation developments (developments occupied by more than one company) we will encourage you to provide road layouts that are to an [adoptable](#) standard and offer them for adoption whenever possible. We will not normally adopt single-occupancy developments.

3.228 Except for [exempted developments](#), we will serve notice under the Advance Payment Code (APC) for all industrial and commercial developments to protect frontagers' interests. The cost of this will reflect the cost of the proposed street works and you should construct the works to an appropriate standard. However, because APCs have been served and money has been paid or retained, we are not indicating any future intention to adopt and maintain the street works at public expense. The requirements of [paragraph 3.212](#) may also apply.

General geometry for site access to the external road network

3.229 Even where you can demonstrate that you cannot achieve a form of [adoptable](#) layout or you do not want your development roads to be adopted, you should still design the site access point to make sure that it does not affect the safety and efficient functioning of the highway or otherwise affect road users.

3.230 You should normally design site access in line with the appropriate parts of the [Design Manual for Roads and Bridges](#) and our [Specification](#) and [standard drawings](#), unless the road to which your development connects falls within the definition of a road (street) as set out in [appendix L](#).

3.231 Office developments (use class B1) up to 3000m² gross floor area (GFA) may be served by a dropped-kerb access arrangement as shown in Figure DG23. However, if you choose this option, you should note that we will recommend imposing planning conditions that restrict any change of use to general employment (use class B2 to B8). Depending on the scale of the development, you will need to obtain our specific approval for the construction details of the access.

The 6Cs Design Guide

Figure DG23 Unadopted access serving up to 3000m² (GFA) of offices

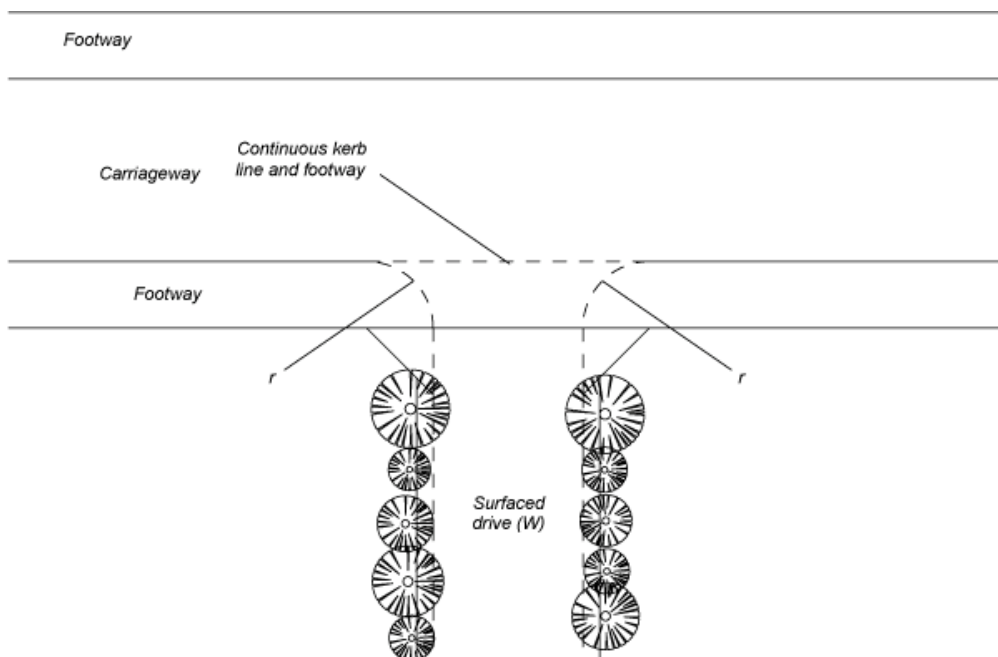

Minimum effective width (w)	6m (Add 0.5m if bounded by a wall on one side, 1m if bounded on both sides.)
Minimum control radii (r)	6m
Vehicle visibility splays	As in Table DG4 , measured from a set back of 2.4m
Pedestrian visibility splays	2m by 2m both sides. No planting permitted
Gradient	Preferably not greater than 1:20 for first 15m, and should never exceed 1:12
Surfacing	Bound material, for example, bituminous or concrete, or block paving for at least the first 15m

3.232 Regardless of the access type, you should provide separate footways or pedestrian routes within the site to minimise the safety risks of pedestrians coming into contact with HGVs. This could be in the form of footways or routes marked on the ground and segregated by bollards or railings.

3.233 Where any gates are to be provided, they should open inwards and be set back a distance appropriate to the type of vehicle likely to require access to the development.

General layout of a private industrial or commercial development

3.234 Even if a road is not to be [adopted](#) you should still seek to make sure that:

- their layouts are safe (both in terms of road safety and personal safety);

The 6Cs Design Guide

- they are accessible to all likely vehicles and other users, including those with impaired mobility; and
- suitable long-term maintenance arrangements are in place.

3.235 You must also take into account the requirements of [BS5906 2005](#) and [Building Regulations Approved Document B, Fire Safety 2006](#), with regard to access for refuse collection and emergency vehicles (see paragraphs [3.221](#) and [3.222](#)). You should design and construct any turning areas within 50m of the access junction to the [adoptable design guidance](#) to minimise the risk of vehicles having to reverse out of the development on to the public highway. The layout of the development should include measures to make sure that parked vehicles do not reduce the use of any turning heads or areas.

3.236 You should also follow the various general guidance contained in this part of the document on personal safety and designing-out crime, and you should seek guidance from the relevant police force 'Architectural Liaison Officer' on proposals for specific sites. You should also make sure that you take into account the needs of people with impaired mobility. For car parking areas, you should follow the guidance in [Section DG14](#).

Section DG20: Marking the highway boundary

3.237 Wherever the extent of the [adoptable highway](#) is not clear – for example there is no wall, fence, or [footway](#) edge – you must install an agreed form of boundary marking.

The 6Cs Design Guide

Part 4 – Materials and Construction

- [Section MC1: General](#)
- [Section MC 2: Designing and managing the environment](#)
- [Section MC 3: Specification](#)
- [Section MC 4: Standard drawings](#)
- [Section MC 5: Site surveys, tests and investigations](#)
- [Section MC 6: Sampling and testing goods and materials](#)
- [Section MC 7: Fencing and barriers](#)
- [Section MC 8: Drainage](#)
- [Section MC 9: Earthworks](#)
- [Section MC 10: Road pavements](#)
- [Section MC 11: Kerbs, footways, footpaths, cycleways and other similar paved areas](#)
- [Section MC 12: Traffic signs, road markings, studs and traffic signals](#)
- [Section MC 13: Street lighting](#)
- [Section MC 14: Street furniture and street art](#)
- [Section MC 15: Highway structures](#)
- [Section MC 16: Soft landscaping and trees](#)
- [Section MC17: Environmental barriers](#)
- [Section MC18: Commuted sums and how we calculate them](#)
- [Section MC19: Schedules of commuted sums for maintenance of works under Section 38 and Section 278 agreements](#)



Section MC1: General

- [Using alternative materials](#)
- [Using alternative materials in conservation areas](#)
- [Using new materials and construction methods](#)
- [Marking the highway boundary](#)

4.1 The standard construction requirements and materials set-out in this Part are based on national standards and advice used in general for constructing and maintaining highways throughout the region. They should normally be applied to **all** highway works and have been chosen to make sure the highways function safely and to make sure that they can be maintained in the most cost-effective way. To achieve these ends, we have considered the principles of quality, durability, maintainability and sustainability.

4.2 This Part also provides details on our [commuted sums](#) policy, including setting out the legal background and how we calculate the sums.

4.3 This part should also be read in conjunction with relevant [standards drawings](#) and accompanying notes and [Specification](#).

The 6Cs Design Guide

Using alternative materials

4.4 We recognise however that applying strict standards for construction details and materials may not always be appropriate to streets in new housing layouts. Among other requirements, the aim in building new developments should be to create places and spaces (including [adoptable](#) highway areas which are attractive, of high quality and have their own distinctive identity while respecting and enhancing local character. The [Manual for Streets](#) sets out that using local materials can strengthen local character by relating a layout to neighbouring developments.

4.5 To recognise and overcome some of the inflexibility that results from using standard materials and so on, we are prepared to allow you to use some alternative materials, landscaping treatment and features. However, if alternative materials and so on are to be used they will need to be:

- to a BS/EN standard;
- easy to maintain and replace;
- durable;
- safe for purpose;
- sustainable; and
- appropriate to the local character.
- durable and suitable for the hierarchy of the road/ footway section and the anticipated traffic/pedestrian flows;
- provide a sustainable solution, including the ability to replace components to maximise the life of the asset;
- accord to the principles of Asset Management and proved good "Whole of Life" cost value in terms of replacement, serviceability and maintenance regimes;
- the use of recycled materials will be considered where appropriate;
- supported by a commuted sum to meet the additional costs in maintaining and replacing non standard assets.

Any alternatives should also not place a burden on our budget. So, where we agree in principle to you using alternative materials and features, we will normally require you to pay a [commuted sum](#) to cover any additional maintenance costs. (Please see [Section MC18](#) for further details on our commuted sums policy).

Using alternative materials in conservation areas

4.6 If you need to use traditional or other agreed non-standard surfacing and kerbing materials in a conservation area, to comply with the requirements of the planning authority you will not normally have to pay a [commuted sum](#). (Please see [Section MC18](#) for further details on our commuted sums policy).

4.7 A characteristic of many villages is the informal appearance of highway edge which consist of grass verges without kerbs. In these areas standard pre-cast concrete kerbs may not be appropriate and you could use natural stone or riven or exposed aggregate kerbs to prevent overriding. It may be desirable to upgrade verges to include kerbs to improve pedestrian safety, drainage and to discourage parking.

The 6Cs Design Guide

Using new materials and construction methods

4.8 We will consider new or innovative materials, construction methods and solutions where this is not likely to increase future maintenance costs or detract from the quality and sustainability of the environment. Where maintenance costs would be increased, but the materials are otherwise acceptable, we will require the payment of [commuted sums](#). Please see [Section MC18](#) for further details on our commuted sums policy.

Marking the highway boundary

4.9 It is important that there is clear demarcation between public and private space. You must define the highway boundary by continuous 50mm x 150mm edging type EF to [BS7263](#) unless we agree otherwise. Alternative approaches to demarcation will be considered on a site by site basis, for example, in conservation areas.



Section MC 2: Designing and managing the environment

4.10 You can find guidance on environmental design and construction of road schemes in volume 10 of the [Design Manual for Roads and Bridges](#) (DMRB). You should use the guidance to help you to identify areas and issues where you need to carefully consider environmental factors. The guidance has been written for trunk road schemes but can be applied to other roads. So we will normally require you to follow it.

4.11 Some plants and animals are given special protection under UK and European law, and volume 10 of [DMRB](#) will give you detailed information and advice. HA 84/01 Nature Conservation and Biodiversity ([DMRB](#) volume 10 Section 4 Part 1) will give you information on who you need to consult, together with other advice including:

- Annex 1 - Seasonal constraints on animals including birds and fish.
- Annex 2 - List of the relevant conventions and legislation.
- Annex 3 - Species advice.
- Annex 4 - Habitat advice.

Section MC 3: Specification

4.12 All highway works must normally be in accordance with:

- the '[Specification for Highway Works](#)' (SHW), published by Her Majesty's Stationery Office as Volume 1 of the Highways Agency's Manual of Contract Documents for Highway Works;
- must comply with the '[Notes for Guidance on the Specification for Highway Works](#)' published by Her Majesty's Stationery Office as Volume 2 of the Highways Agency's Manual of Contract Documents for Highway Works; and
- our '[Specification for Highway Works for Development](#)'.

The 6Cs Design Guide

You should use the copies of the document that are current when you design works under Section 38 or Section 278 agreements.

4.13 Some of the clauses and Appendices in our Specification contain additions and amendments to the SHW. Where the Specification clauses and Appendices in our document vary from the SHW, the ones in our document will apply.

Section MC 4: Standard drawings

4.14 All works must normally comply with our standard drawings. You can find these for the region at www.leics.gov.uk/standard_drawings.htm. You should check that you are using current drawings.

4.15 The standard drawings include extensive notes, including notes about construction, which supplement the drawings and Specification. You should read these notes when you refer to standard drawings.

4.16 If your proposals are not covered by the standard drawings, you will need to submit scheme-specific drawings to us for approval. You should do this at the earliest opportunity in the design process.



Section MC 5: Site surveys, tests and investigations

4.17 You must arrange any site surveys, tests and investigations that we need before you submit your design to us. These must cover:

- a land survey including features such as:
 - watercourses;
 - ditches;
 - existing drainage systems and outfalls; and
 - services and existing foundations;
- a survey of existing trees and other soft landscape features including:
 - the condition of each tree;
 - its size and form; and
 - details of tree preservation orders and so on;
- nature-conservation surveys;
- details of how surface water run-off will be dispersed;

The 6Cs Design Guide

- consultation with the [Environment Agency](#);
- the depth of the water table and perched water tables;
- the impact on adjacent developments and land;
- a risk assessment of chemical contamination;
- the presence of hazardous materials;
- the stability and acceptability of earthworks;
- an assessment of subgrade strength;
- the frost susceptibility of subgrade;
- the suitability of subgrade soils for lime or cement stabilisation (if required); and
- the possible recycling of on-site materials.

4.18 You must submit the results of the tests to our Engineer before you begin construction.

Section MC 6: Sampling and testing goods and materials

4.19 You must arrange and pay for all the sampling and testing outlined in Appendix 1/5 of our [Specification](#). You must also submit one copy of these test results to our Engineer.

4.20 Our Engineer reserves the right to carry out any sampling and testing he or she feels is necessary to confirm that the goods and materials meet with the Specification. They can also core through any pavement construction at any stage to check the thickness of the layers and the type and standard of construction. If we find the work does not meet the Specification, you will be required to pay for the associated costs to the authority. You can find a list of the samples of goods and materials which we may ask you to supply to check you are meeting the Specification in Appendix 1/6 of our [Specification](#).



Section MC 7: Fencing and barriers

- [General](#)
- [Safety fences and barriers](#)
- [Pedestrian barriers](#)
- [Pedestrian guardrails](#)
- [Noise fencing](#)

General

4.21 We will not [adopt](#) any fencing erected on the highway boundary unless it:

The 6Cs Design Guide

- is provided as a safety feature at the top of any structure retaining the highway;
- provides protection against a hazard existing on the adjacent land; or
- is a noise barrier (See [Section MC17](#)).

In other circumstances it will be necessary to establish who is responsible for maintaining the fencing in the early stages of our discussions with you.

4.22 For works that we are to adopt, you can find details of fencing, including brook railings, boundary markers, gates and stiles and pedestrian guardrails in the [standard drawings](#) and Appendices 4/1 and 4/2 of our [Specification](#).

Safety fences and barriers

- 4.23 Safety fences and barriers must comply with Section 2 of '[Highway Construction Details](#)' published by Her Majesty's Stationery Office as Volume 3 of the Highways Agency's Manual of Contract Documents for Highway Works. Safety Fencing should not generally be included within residential developments as the need should be designed out to provide layouts that provide places for living. Where safety fencing is unavoidable or required to address existing situations where problems exist or circumstances have changed then reference should be made to the RRRAP (Road Restraint Risk Assessment Process) contained in TD 19/06 where flows are appropriate. In the event that flows are not sufficient to meet the thresholds in this guidance then individual risk assessment should be made in conjunction with Road Safety / Safety Audit. Care should be taken to avoid the use of safety fencing to protect road users from the dangers of other objects or hazards within the highway boundary by first determining whether the objects in question could be relocated to remove the hazard

Pedestrian barriers

4.24 Where a footpath joins a road you must provide staggered barriers to:

- prevent pedestrians running straight out into the road; and
- reduce the likelihood of misuse by cyclists.

You can find details of these barriers in the [standard drawings](#).

4.25 Where using a staggered barrier is not appropriate, you must provide an agreed length of pedestrian guardrail which runs parallel to the edge of the road, leaving a clearance of 450mm from the carriageway. You may need to widen the footway to maintain the standard footway width past the guardrail.

Pedestrian guardrails

4.26 You must use guardrails where the number of pedestrians makes it necessary for you to channel them to the appropriate crossing point. You should take care to make sure that the guardrails do not interrupt visibility. You should normally use high visibility pedestrian guardrail.

The 6Cs Design Guide

Noise fencing

4.27 Unless we agree otherwise, you should treat noise fencing as a highway structure. As such, it must meet the design requirements for a structure and you must pay us design checking fees and a [commuted sum](#) for its future maintenance. You can find more information on noise fencing in [Section MC17](#). Please see [Section MC18](#) for further details on our commuted sums policy.

Figure MC1 Example of noise fencing



Section MC 8: Drainage

- [General](#)
- [Land drainage](#)
- [Existing drainage systems](#)
- [Sustainable urban drainage systems \(SUDS\)](#)
- [The hydraulic design of adoptable highway drains](#)

The 6Cs Design Guide

- [Hydraulic design – protection against flooding](#)
- [Minimum pipe size](#)
- [Approving drainage structures](#)
- [Catchpits](#)
- [Catchpit and manhole positions](#)
- [Positioning and alignment of highway drains and storm and foul sewers](#)
- [Gullies](#)
- [Providing sub-soil drainage](#)
- [Backfilling trenches](#)

General

4.28 Normally the highway drainage on new developments is connected to a drainage system that is adopted by the water company and is subject to a Section 104 agreement under the [Water Industry Act 1991](#). You must provide evidence of this agreement before we will agree to sign a [Section 38 agreement](#). We will not [adopt](#) the roads until the water company has issued a provisional certificate of adoption for the drainage system or it is to be adopted by us as a highway drain.

4.29 All highway drains should be located within land that we are adopting. Only in exceptional circumstances will we permit them in land that is to remain private. You must cover any adoptable highway drain outside the limits of the adoptable highway by an [easement agreement](#). This should be in place before, or be a condition of, the Section 38 or 278 agreement.

4.30 You must provide written evidence of the right to discharge water from a highway drain into any receiving ditch or watercourse with no liability on us. The Environment Agency will approve all such discharges and you must provide us with written evidence that you have received any approval and consents you need.

4.31 Where a piped system discharges into an existing ditch or watercourse, the pipe invert (bottom of the inside of the pipe) must not be lower than the level of the average flow in the ditch or watercourse and it should always be at least 150mm above the ditch or watercourse invert. You must direct the end of the pipe so it discharges at an angle less than 60 degrees to the direction of flow in the ditch or watercourse. The end of the pipe must have a headwall and apron which supports the bank above and adjacent to the pipe and prevents any scouring underneath the pipe. You must protect the banks of the ditch or watercourse from scouring. You must meet any requirements laid down by the Environment Agency.

4.32 You must install oil interceptors as required by the Environment Agency.

4.33 If the outfall is to an existing highway drain, you will have to prove its capacity and condition before we can approve the connection. For all works incorporating highway drainage you will need to carry out and provide a copy of a [CCTV](#) survey and report. You must carry out any improvement works found necessary, all at your expense.

4.34 We will not normally accept drainage of other non-adopted areas into an existing or adoptable highway drain.

The 6Cs Design Guide

4.35 Where private non-adoptable drives and other surfaces fall towards the adoptable highway, you must prevent surface water run-off from reaching the highway boundary and entering the highway drainage system.

Land drainage

4.36 Where there is or is likely to be run-off from landscaped areas, open spaces and adjoining land, you must make appropriate arrangements for land drainage. This can include providing intercepting drains and ditches with satisfactory outfalls.

Existing drainage systems

4.37 You must deal with any drainage systems existing within the development site, including any land drains, ditches, watercourses, outfalls from adjacent land or drainage systems, to our satisfaction and that of the [Environment Agency](#) and the owner of the systems. You must have the consent of the [Environment Agency](#) for piping an existing ditch or watercourse, in accordance with Section 23 of the [Land Drainage Act 1991](#).

Sustainable urban drainage systems (SUDS)

4.38 Where you are proposing SUDS for highway drainage, you must enter into discussions with all relevant parties at an early stage (and certainly before any planning application) to agree ownership and responsibility for the facility. (You may need to address this as part of a concept proposal that you are required to prepare for your proposed development. Please see [Part 2, Section PDP2](#) for further information on concept proposals). We will not [adopt](#) your road unless we are satisfied with the design of the system and that satisfactory arrangements are in place to cover its future maintenance.

4.39 If we are to adopt SUDS and non-standard drain elements, including above-and below-ground flow attenuation systems and pollution control devices, we will require you to pay a [commuted sum](#) to cover future maintenance. (Please see [Section MC18](#) for further details on our commuted sums policy).

The hydraulic design of adoptable highway drains

4.40 The hydraulic design of adoptable piped highway drains must meet the requirements of the current edition of '[Sewers for Adoption](#)' published by WRc plc.

4.41 You must submit calculations using the specified method of calculation and format. We will accept output from an approved computer programme using the specified method and parameters.

Hydraulic design – protection against flooding

4.42 The system must be designed to meet the requirements of the current edition of '[Sewers for Adoption](#)' published by WRc plc.

4.43 The system should be designed not to flood any part of the highway or site in a [1 in 30 year return period design storm](#) or any other return period that is set out in any latest version of 'Sewers for Adoption'.

4.44 Your design should also show the line and extent of flow paths and the potential effects of flooding if storms are greater than those allowed for by your design.

The 6Cs Design Guide

Minimum pipe size

4.45 The minimum pipe diameter for [adoptable](#) highway drains, other than gully connections, is 225mm. The minimum size for a road gully connection is 150mm.

Use of combined kerb and drainage systems

4.46 You must consider a combined kerb and drainage system where the minimum [longitudinal carriageway gradient](#) is less than 1 in 100 for flexible surfaces and less than 1 in 80 for block paved surfaces. Please see our [standard drawing](#) for details. We will normally require you to pay a [commuted sum](#) to cover any additional maintenance where a combined drainage system is used.

Figure MC2 Example of a combined kerb and drainage system



Approving drainage structures

4.47 Any:

- drain, piped or [box culvert](#), sewer or drainage structure that has a clear span or internal diameter of greater than 900mm; and
- headwall greater than 1.5m retained height;

will be classified as a highway structure and be subject to the specific requirements that apply to highway structures.

Catchpits

4.48 Unless otherwise specified, you must use catchpits and not manholes on [adoptable](#) highway drainage systems. [SUDS](#) structures (typically over-sized chambers and cover slabs which are greater than 1050mm in diameter), even if they are to be adopted by the

The 6Cs Design Guide

relevant water company, must still be designed to the relevant standards for retention within the highway ([British Standard 5400](#)). You will need to demonstrate to us that this has been achieved

4.49 You must provide a catchpit (an access chamber, with sump, on a drainage system) where there is any discharge into an existing ditch or watercourse.

4.50 On all drainage runs we are to adopt where the pipe diameter is 900mm or less, you must provide a catchpit at:

- every change of alignment or gradient;
- the head of all main pipelines;
- every junction of pipelines except for single-gulley connections;
- every change in pipe diameters; and
- a maximum spacing of 90 metres.

Catchpit and manhole positions

4.51 You should normally locate [catchpits](#) or [manholes](#) within the verge, and not the carriageway, on classified roads and other roads with a higher status than a [residential access road](#) or [industrial access road](#). The outside of catchpits and manholes should be at least 500mm from the kerb line or the edge of the carriageway. Any catchpits or manholes within a carriageway must be located so that they can be accessed while providing the necessary safety zones and without preventing traffic from passing. This will generally mean that you should not site them at or near the centre of the carriageway or within a width restriction. You should also take care when locating catchpits or manholes within junctions or roundabouts, based on the same criteria.

Positioning and alignment of highway drains and storm and foul sewers

4.52 Highway drains must be laid:

- in straight lengths;
- to straight grades between catchpits; and
- within the carriageway or verge.

You must not lay drains and sewers and their associated catchpits or manholes in footways as this space is required for other utility apparatus. As described in [paragraph 4.29](#), all highway drainage should be located within land that we are [adopting](#).

Gullies

4.53 All gullies should be trapped and the maximum length of gulley connection should not be more than 15m. It will not normally be acceptable to connect one gulley connection directly into another. Gully spacing should be calculated from Table MC1 and the accompanying notes:

The 6Cs Design Guide

Table MC1: Gully spacing

Carriageway Gradient	1/100	1/80	1/60	1/40 or steeper
Area drained (including footways etc.) (in m ² (a))	170 (b) (c)	180 (b) (c)	200 (b) (c)	240 (b) (c)

(a) When calculating the areas drained, you must make allowances for all footways, footpaths, paved areas and verges that fall towards the carriageway.

(b) Gullies must not be spaced more than 40m apart, irrespective of the areas drained, except at summits where the first gully should not be more than 40m from the high point.

(c) Double gullies must always be provided at sag points and low points and each must have its individual connection to the main sewer or highway drain.

4.54 In footpaths, footways and cycleways separated from carriageways, you must provide gullies or channels connected to the highway drainage system where surface water would otherwise discharge onto adjacent property or cause flooding of [footpaths](#), [footways](#) or carriageways.

4.55 You should site gullies upstream of the tangent point at road junctions so that surface water in the channel does not flow across the junction. You should take care to avoid ponding near the mid-point of radius kerbs. Where the road is super-elevated, you should site a gully just before the point where the adverse camber is removed to prevent water in the upstream channel flowing across the carriageway.

4.56 You should take care to avoid ponding in the transition length, when the longitudinal gradient is flat or where there are traffic islands, central reserves or traffic-calming measures. You must not site gullies within pedestrian crossing points. Where possible, locate them directly upstream of the crossing point.

4.57 You should not site gullies where traffic would be prevented from passing while they are being emptied, for example within a carriageway width restriction.

4.58 You will need to provide us with a contour plan to show that gullies are located in the correct position as part of your design submission for works under [Section 38](#) or [Section 278](#) agreements.

Providing sub-soil drainage

4.59 You must construct a system of sub-soil drainage to a suitable agreed outfall all to our satisfaction where:

- the winter height of the water table is within 600mm of formation level; or
- the sub-soil is unstable because of being waterlogged; or
- there is a likelihood of water running from or out of adjacent ground; or
- springs, land drains or watercourses are present; or
- the finished road is below existing ground level, regardless of the water table; or
- the sub-grade is likely to be altered due to groundwater.

The 6Cs Design Guide

Backfilling trenches

4.60 You must backfill all drainage, utility and other trenches in the highway for industrial and commercial premises up to formation level with GSB type1 granular sub-base material. Backfill on residential sites should be a granular material to the approval of the highway authority (acceptable material will typically include GSB type 1 or material graded to 6F1).



Section MC 9: Earthworks

- [General](#)

General

4.61 All earthworks must comply with Series 600 and Appendices 6/1, 6/2, 6/7 and 6/8 of our [Specification](#).

4.62 Embankments and other areas of fill must:

- be formed of acceptable material excavated from within the site or imported on to the site;
- meet the requirements of Appendix 6/1 of our [Specification](#) for use in the permanent works; and
- have the approval of our Engineer to be used in that particular location.



Section MC 10: Road pavements

- [Constructing the site access and roads external to a development](#)
- [Internal development roads](#)
- [Subgrade assessment](#)
- [Carriageway sub-base and capping layer](#)
- [Frost susceptibility](#)
- [Capping materials](#)
- [Sub-base](#)
- [Surface and binder courses and bases](#)
- [Concrete-block paving](#)
- [High Friction Surfacing](#)
- [Coloured Surfacing](#)

The 6Cs Design Guide

- [Alternative materials for carriageways and shared surface areas](#)
- [Resurfacing carriageways at junctions with existing county roads and widening existing county roads](#)
- [Speed control humps](#)
- [Speed control bends](#)
- [Entry ramps](#)

Constructing the site access and roads external to a development

4.63 The design and construction of works on classified roads and other roads (existing or proposed) not covered by this design guide must normally comply with the '[Design Manual for Roads and Bridges](#)' published by Her Majesty's Stationary Office.

Internal development roads

4.64 Listed below are the road types covered by this design guide. The construction varies according to the road type. It is essential that you mark the road category clearly on the plans you submit for approval in line with the abbreviations in Table MC2. You can find further details of the road types in [Part 3, Section DG2](#).

Table MC2: Development road types

Road category	Abbreviation
Residential access road	RAR
Residential access way	RAW
Major industrial access road	MajIAR
Minor industrial access road	MinIAR

Subgrade assessment

4.65 For design purposes, you must estimate the [CBR](#) before you begin construction. You should notify us in advance of site tests to establish the subgrade strength and give us the opportunity to be present at such tests. You should provide the highway authority with copies of all test results.

4.66 You should use soil-classification tests to give the types of soil an 'Equilibrium CBR' based on material type, using Table MC3, unless we agree otherwise.

Table MC3: Equilibrium CBR values to be used for design purposes within Leicestershire^(a)

Type of soil	Plasticity index	Equilibrium CBR %
Heavy clay	50 or greater	Less than 2
Heavy clay	40 to 49	2
Heavy clay	30 to 39	2
Silty clay	20 to 29	3
Sandy clay	10 to 19	4
Silt	Less than 10	1
Sand (poorly graded)	Non-plastic	20

The 6Cs Design Guide

Sand (well graded)	Non-plastic	40
Gravel (poorly graded)	Non-plastic	40
Sandy gravel (well graded)	Non-plastic	60

(a) Based on [Design Manual for Roads and Bridges](#) 7.2.2 HD 25/94.

Carriageway sub-base and capping layer

4.67 Use Table MC4 to find the thickness of [capping](#) and [sub-base](#) you need to use.

Table MC4: Carriageway sub-base and capping thickness^(a)

CBR Value	Min 450mm Frost Susceptibility (see clause 4.68)					
	Access Road 250mm (Bituminus layer thickness)		Access Way (200mm Bituminus layer thickness)		Industrial Road (300mm Bituminus layer thickness)	
	Capping	Sub Base	Capping	Sub Base	Capping	Sub Base
Less than 2%	550	200	500	250	600	150
2%	400	200	350	250	450	150
3%	300	200	250	250	350	150
4%	250	200	200	250	300	150
5% to 15%	200	200	200	250	250	150
More than 15%		200		250		150

(a) The foundation design should not vary frequently along the road. You should select an appropriate value for each significant change in the subgrade properties.

(b) Where the equilibrium CBR falls between values in the above table, you should round down the value to the lower value.

(c) When the subgrade CBR is sufficiently below 2% that capping with sub-base is not sufficient to support the pavement, special measures will be required. Note that the use of geo-textile will only be acceptable in certain situations. You can find advice in [DMRB](#) 7.2.2 HD25/94.

Frost susceptibility

4.68 Material within 450mm of the finished road surface must not be frost susceptible.

Capping materials

4.69 You will need approval for each site for the capping layer which must comply with our [SHW](#) Table 6/1, Type 6F2 or 6F3. You must test the capping layer as necessary to demonstrate that it has an in-situ CBR of 15% (or equivalent test result). We may approve other materials as long as you have previously demonstrated to us that they will achieve an in-situ CBR of 15% (or equivalent test results).

Sub-base

4.70 Sub-base must be Type 1 to Clause 803 of the [Highways Agency Specification](#).

The 6Cs Design Guide

Surface and binder courses and bases

4.71 Table MC5 gives the:

- required minimum design thicknesses; and
- options you have for the flexible and modular (block) materials you should normally use for different development road types.

Roads not covered by this table should be designed on a site-by-site basis to [Design Manual for Roads and Bridges](#), Volume 7. Where it is necessary to alter or improve an existing road to serve a development, in all cases the minimum depth of surface course, binder course and base layer should normally not be less than that of the site access road, as given in Table MC5. For example, if you are widening a road to serve a housing development accessed by a 'residential access road', then the material depth should not be less than 250mm - equal to 40mm+60mm +150mm. It may be necessary to overlay the existing carriageway to achieve the required depth.

Table MC5: Road carriageway construction depths

Table MC5: Road carriageway construction materials and depths												
	Residential access roads			Residential access ways			Industrial access roads			notes		
	Bituminous		Block	Bituminous		Block	Bituminous					
Surface course	40mm	SMA 10 surf 40/60 (PSV 55)	1.2	80mm	40mm	SMA 10 surf 40/60 (PSV55)	1.2	80mm	50mm	HRA 33/14 F surf 40/60 des (20mm pre-coats)	1	
		(MHA material reference BC2)									(MHA material reference BC3)	
	40mm	HRA 55/10 F surf 40/60 des	2		40mm	HRA 55/10 F surf 40/60 des	2					
		(MHA material reference BC1)										
	40mm	AC 10 Close surf 100/150	2	40mm	AC 10 Close surf 100/150	2						
		(MHA material reference BC1)				(MHA material reference BC1)						
Binder course	60mm	AC20 dense bin 100/150 rec		30 mm sand 60mm AC20 dense bin 100/150 rec MHA material reference BC2	50mm	AC20 dense bin 100/150 rec		30mm sand 110mm AC20 dense bin 40/60 rec HMA material reference BC1	60mm	AC20 dense bin 40/60 rec		
		(MHA material reference BC2)					(MHA material reference BC2)					(MHA material reference BC1)
									60mm	AC20 HDM bin 40/60 des		
										(MHA material reference BC4)		
Base	150mm	AC32 base 40/60 rec		100mm AC32 base 40/60 rec MHA material reference B1	110mm	AC32 base 40/60 rec			190mm	AC32 base 40/60 rec	3	
		(MHA material reference B1)					(MHA material reference B1)					(MHA material reference B1)
										AC32 HDM base 40/60 des	3	
										(MHA material reference B4)		

1 Polished stone value (PSV) of course aggregate in surfacing course shall be determined from the Table of Investigatory Levels, see DMRB Part 1 HD 36/06. (<http://www.dft.gov.uk/ha/standards/dmrb/vol7/section5/hd3606.pdf>) however Leicestershire use the table in Appendix M, but should not be less than 55.

2 HRA 55/10 bin 40/60 (material ref REG1) may be used for hand laying speed tables.

3 Subgrade assessment capping layer/sub-base design are covered in Section MC10 paras 4.65 - 4.7

4 However for Leicestershire any Binder course material laid as a running surface prior to the final surface course being laid must have a minimum PSV of 55 and a AAV of 7 this includes under block paved surfaces in carriageways.

Key

HRA = Hot rolled asphalt;

CGM = Close graded macadam;

HSCA = High stone content asphalt;

DBM = Dense bitumen macadam

Note: We will not usually accept the use of block-paving for industrial roads.

4.72 We may agree to you using stone mastic asphalt (SMA) as an alternative surface course material. You must make up any reduction in thickness of the surface course by increasing the thickness of the binder course by an equal amount. If you use SMA, we will

The 6Cs Design Guide

require you to pay a [commuted sum](#) for the additional maintenance cost. (Please see [Section MC18](#) for further details on our commuted sums policy).

4.73 You can find full details of the permitted standard materials in Appendix 7/1 of our [Specification](#).

Concrete-block paving

4.74 Where we agree that it is appropriate, you may lay concrete-block paving to carriageways, shared surfaces and other areas used by vehicles. This should be laid instead of the surface course and binder course on the standard thickness and materials for the sub-base and base layers for the road type in question. Note that a binder course will be required as per Table MC5. The concrete block paving must comply with and be laid in accordance with the requirements of Appendix 11/1 of our [Specification](#) for concrete-block paving in carriageways.

4.75 If you use block paving you may need to pay a [commuted sum](#) as indicated in [Table MC6](#).

High Friction Surfacing

4.76 You are required to provide high friction surfacing on the approaches to signal-controlled junctions, roundabouts and pedestrian crossings unless we agree otherwise. This will be either hot applied (thermoplastic) or cold applied (thermosetting) and must be in accordance with Appendix 7/1 of our [Specification](#).

4.77 High friction surfacing must be applied for a minimum length of 50m ahead of the stop-line on roads subject to a 30 mph limit, but an increased length may be required due to the approach speed, accident record, average queue length, proximity of side roads and mix of traffic. Outside 30mph limits you should provide a minimum length equal to the stopping distance for the approach speed plus 10 m. On approaches to pedestrian crossings the high friction surfacing must be continued past the stop-line to the first line of crossing studs.

4.78 Hot applied systems can take advantage of smaller 'windows' of good weather in the winter period. They also need only a short period of time before the road can be re-opened to traffic because they cool to ambient road temperature quite quickly. This can be an advantage in traffic-sensitive situations (for example, where a prolonged closure would result in major traffic diversions and disruption). The length of time needed for a cold applied system to set can be typically three to six hours at a reasonable ambient air temperature (above 10°C). This makes it less suitable for applying in winter and applying in areas where closure for long periods would cause problems.

4.79 To reduce the risk of high friction surface systems failing too soon after application, they are best applied to surface courses that have been used by traffic for some weeks before the surfacing is installed. Further advice is included in [DMRB](#) volume 7 section 5 part 2 (HD 37/99).

Coloured Surfacing

4.80 This will be either hot applied (thermoplastic) or cold applied (thermosetting) and must be in accordance with Appendix 7/1 of our [Specification](#).

The 6Cs Design Guide

4.81 Hot applied systems can take advantage of smaller 'windows' of good weather in the winter period. They also need only a short period of time before the road can be re-opened to traffic because they cool to ambient road temperature quite quickly. This can be an advantage in traffic-sensitive situations (for example, where a prolonged closure would result in major traffic diversions and disruption). The length of time needed for a cold applied system to set can be three to six hours at a reasonable ambient air temperature (above 10°C). This makes it less suitable for applying in winter and applying in areas where closure for long periods would cause problems.

4.82 To reduce the risk of coloured surfacing systems failing too soon after application, they are best applied to surface courses that have been used by traffic for some weeks the surfacing is installed.

4.83 We will require the payment of [commuted sums](#) to cover the future maintenance of such surfacing. Please also see [Section MC18](#) for further details on our commuted sums policy.

Alternative materials for carriageways and shared surface areas

4.84 Where for aesthetic, environmental, or other such reasons you propose to use an alternative surfacing material, we will be prepared to consider its use so long as:

- we have agreed its use at an early stage;
- the material meets the requirements of quality, durability, maintainability and sustainability; and
- in the interest of highway safety the material must meet Specification requirements in terms of polished stone value (PSV), aggregate abrasion value (AAV) and so on as specified for surfacing materials in Appendix 7/1 of our [Specification](#) unless otherwise agreed.

To ensure that the surface can be kept safe and durable, we will need you to pay a [commuted sum](#) to cover the excess maintenance costs of most alternative materials and surfaces. Table MC6 gives a guide to indicate the types of materials you will have to pay a [commuted sum](#) for. Please also see [Section MC18](#) for further details on our commuted sums policy.

Table MC6: Alternative surfaces for road and shared surface areas and commuted sum requirements

Normal alternative surfacing materials ^(a)	Commuted sum payable?
Surface dressing using locally-sourced granite aggregate chippings	No
Surface dressing using crushed rock aggregate from a specific non-local source	Yes
Surface dressing using pea gravel aggregate from a local source	Yes
Surface dressing using pea gravel aggregate from a non-local source	Yes
Surface dressing using crushed gravel aggregate from a local source	Yes
Surface dressing using crushed gravel aggregate from a non-local source	Yes
Stone mastic asphalt	Yes

The 6Cs Design Guide

Hot or cold applied coloured surfacing (resin system)	Yes
Standard surface course materials using a coloured binder and coloured aggregate or chippings	Yes
'Imprint' or other similar approved hot-applied, polymer-modified, synthetic bitumen-based compound, surface-applied block paving alternative finish	Yes
Standard 80mm concrete-block paving surface course	Yes for other than shared surface areas
'Tegula' or similar approved concrete-block paving surface course	Yes

(a) We will be prepared to consider other materials not listed above, so long as, among other things:

- you meet the requirements listed in [paragraph 4.84](#);
- you can provide evidence of where the material has been used in similar circumstances and how durable it has been;
- the safe and satisfactory operation of the highway would not be threatened;
- accessibility is not threatened, including for pedestrians, cyclists and people with disabilities; and
- you pay a commuted sum where the future maintenance costs are greater than they would be if you used the more usual surfacing instead.

Resurfacing carriageways at junctions with existing roads and widening existing roads

4.85 Where a new carriageway meets an existing county road or an existing county road is widened and:

- the construction joint falls within the running lane of the existing county road; or
- involves any changes to the county-road carriageway, including additional areas of carriageway;

you must overlay or resurface the whole of the altered or widened carriageway unless we agree otherwise. At junctions, you must carry this out over the length from tangent point to tangent point of the junction radii. However, if the junction includes acceleration and deceleration splays (lanes) on the main carriageway, the full overlay or resurfacing of the whole carriageway must also include the full length of the splays, unless we agree otherwise.

(a) This applies to any adopted ([Glossary - Part 8](#)) road, other than those maintained by the Highways Agency.

The 6Cs Design Guide

Speed control humps

4.86 You should only use vertical speed control measures where it has been agreed that vehicle speeds cannot be controlled either through site layout or horizontal speed control measures. (See [Part 3, Section DG5](#) for further details).

4.87 On bus routes speed control humps must comply with [paragraph 3.96 of Part 3](#).

4.88 Other than on bus routes, speed control humps must be flat topped humps or junction tables with a minimum plateau length of 7m and height of 75mm. Approach ramps should normally have a gradient of 1 in 13. Where the carriageway has a longitudinal gradient approaching the maximum allowed then the “uphill” ramp gradient should be 1 in 15 and the “downhill” ramp gradient should be 1 in 13.

4.89 The humps and tables must be constructed in bituminous material (unless used on a block-paved carriageway or shared surface where they should be constructed in the same material as the carriageway), using 55%/10mm medium temperature asphalt to [BS 594](#) column 3/4 unless otherwise agreed.

4.90 We will require the payment of [commuted sums](#) to cover the future maintenance of speed control humps and similar vertical traffic calming measures. Please also see [Section MC18](#) for further details on our commuted sums policy.

Speed control bends

4.91 An overrun area must be provided to the inside of speed-control bends (a bend with an inside radius of 8m or less). It should normally be constructed as follows.

- The outer kerbline should be formed using 125mm x 150mm bull-nosed kerbs with 12mm to 15mm upstand.
- The inner kerbline should be formed using 8m radius 125mm x 225mm half-batter kerbs.
- It should be surfaced using granite setts (or other approved material) of a colour which contrasts with the main carriageway.
- Setts are to be laid with a 6mm level difference between rows to form a rumble area.

Setts are to be laid with Class 2 cement mortar bed to Clause 2404 of the [Highways Agency Specification](#), minimum thickness 15mm, on a 150mm thick C15P concrete bed with full depth road construction below.

- It should have a [crossfall](#) of 1 in 30 towards the other kerbline.

The 6Cs Design Guide

Figure MC3 Overrun areas

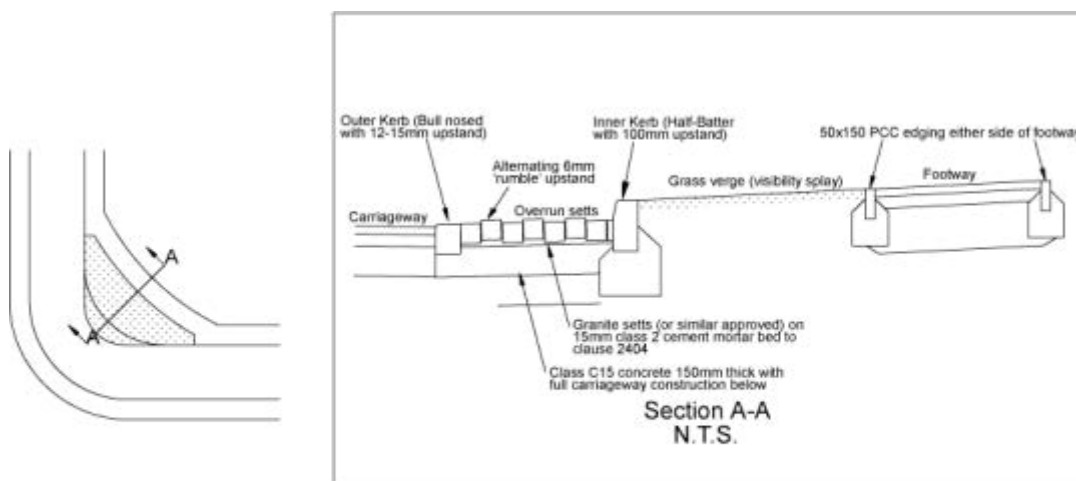

Notes:

1. Change in direction to be not less than 70° or more than 100° within a distance of 32m measured along the inside kerb
2. The through view beyond the bend on to the approach should be blocked by buildings walls or dense planting etc.
3. A 15m separating straight is required after the speed control bend if the road curves in a reverse direction
4. There should be no vehicular accesses over the length of the forward visibility curve

Entry ramps

4.92 [Entry ramps](#) should normally have a gradient of 1 in 13 and a height between 75mm and 100mm.



Section MC 11: Kerbs, footways, footpaths, cycleways and other similar paved areas

- [General](#)
- [Concrete-block paving](#)
- [Pedestrian deterrent paving](#)
- [Strengthening footways to accommodate heavy-vehicle parking or over-running](#)
- [Footways and other hard-paved areas on industrial access roads](#)
- [Additional paved areas](#)
- [Flush dropped pedestrian and cyclist crossing points](#)
- [Tactile paving surfaces](#)
- [Alternative surfacing materials for footways and cycleways](#)
- [Widening existing footways, footpaths and cycleways](#)

The 6Cs Design Guide

General

4.93 The construction should be in line with Table MC7. You should also refer to the [standard drawings](#) and Appendix 11/1 of our [Specification](#).

Residential footways

Table MC7: Residential footway construction depths

Table MC7 : Residential Footways - construction materials and depths				
	Bituminous		Block Paving	
Surfacing	20mm	AC 6 dense surf 100/150 (MHA material reference SC12)	90mm	60mm blocks on 30mm bedding sand (compacted)
Base course	50mm	AC20 dense bin 160/220 rec (MHA material reference BC3)	70mm	AC20 dense bin 160/220 rec (MHA material reference BC3)
Sub-base	160mm	Granular Type 1 (MHA material reference SB1)	150mm	Granular Type 1 (MHA material reference SB1)
	OR			
	225mm	Granular Type 1 (MHA material reference SB1)		includes vehicular crossings serving 5 or less dwellings
		vehicular crossings serving 5 or less dwellings		

DBM = Dense bitumen macadam

GSB = Granular sub-base

⁽¹⁾ Footway crossing construction to serve developments of more than five dwellings. See [Table DG15](#).

Concrete-block paving

4.94 Where we agree that it is appropriate, you may lay concrete-block paving to footways and other paved areas. The concrete block paving must comply with and be laid in line with the requirements of Appendix 11/1 of our [Specification](#) for concrete-block paving in footways.

4.95 If you use block paving you may need to pay a [commuted sum](#) as indicated in [Table MC9](#).

Pedestrian deterrent paving

4.96 You should use approved pedestrian-deterrent paving in areas where pedestrians are to be discouraged.

Strengthening footways to accommodate heavy-vehicle parking or over-running

4.97 You must strengthen residential footways where heavy vehicles such as delivery (service) and maintenance vehicles, refuse lorries and buses are likely to be parked on them or overrun them. See [Table MC7a](#) for details.

The 6Cs Design Guide

Table MC7a: Strengthening residential footways

Table MC7a : Strengthening Residential Footways - construction materials and depths				
	Bituminous		Block Paving	
Surfacing	25mm	AC 6 dense surf 100/150 (MHA material reference SC12)	90mm	60mm blocks on 30mm bedding sand (compacted)
Base course	90mm	AC20 dense bin 160/220 rec (MHA material reference BC3)	90mm	AC20 dense bin 160/220 rec (MHA material reference BC3)
Sub-base	270mm	Granular Type 1 (MHA material reference SB1)	270mm	Granular Type 1 (MHA material reference SB1)

(a)The sub-base is to be increased to 365mm for CBR's of 2% or less

Footways and other hard-paved areas on industrial access roads

4.98 The construction should be in line with [Table MC8](#). Where a footway crossing is to be used to access an employment or commercial development (as allowed for in [Part 3, Section DG19](#)), the footway crossing must be constructed in line with industrial access road requirements given in [Table MC5](#).

Table MC8: Footways and paved areas on industrial access roads

Table MC8 : Footways and paved areas on industrial access roads - construction		
	Bituminous	
Surfacing	40mm	HRA 55/10 F surf 100/150 des (MHA material reference SC8)
Base course	75mm	AC20 dense bin 160/220 rec (MHA material reference BC3)
Sub-base	270mm	Granular Type 1 (MHA material reference SB1)

(a)The sub-base is to be increased to 365mm for CBRs of 2% or less

4.99 Where there is a likelihood of regular parking on hard-paved areas or areas that would otherwise be grassed, you should use high-relief contour paving to deter vehicles.

Additional paved areas

4.100 Where the overall layout of the development includes areas which exceed normal requirements for the safe and satisfactory operation of the highway but which we have agreed to include in the [adoptable](#) area, you will have to pay a [commuted sum](#) for the cost of maintaining that area. This will include the costs of using any permitted alternative

The 6Cs Design Guide

surfacing materials. Please also see [Section MC18](#) for further details on our commuted sums policy.

4.101 If you need to provide additional width for visibility at junctions, inside bends and for other reasons, you must hard pave any small 'verge' areas that result. Normally this would apply to a minimum width of 1m and a minimum area of 10m² for grass and 6m² for shrub and ground-cover planting. However, 'verge' areas bigger than 10m² should not normally be hard paved, instead they should be soft landscaped (grassed or planted and so on) unless the paving forms part of the design concept and we have agreed it at an early stage.

Flush dropped pedestrian and cyclist crossing points

4.102 You must provide these at all points where pedestrians and cyclists cross or join a carriageway (including any access more than a simple vehicular footway crossing). These crossing points will normally be constructed to our normal [standard drawing](#) (SD/11/8, Flush-dropped crossings - Type B). You should only construct crossings to our alternative standard drawing (SD/11/7, Flush-dropped crossings - Type A) at locations we have agreed.

Tactile paving surfaces

4.103 You should construct tactile paving surfaces at all controlled and uncontrolled crossing points in accordance with the government publication '[Guidance on the use of Tactile Paving Surfaces](#)' and our [standard drawings](#).

Alternative surfacing materials for footways and cycleways

4.104 Where for aesthetic, environmental, or other such reasons you propose to use an alternative surfacing material, we will be prepared to consider its use so as long as:

- we have agreed its use at an early stage; and
- the requirements of quality, durability, maintainability and sustainability are met.

To make sure that the surfaces can be kept safe and durable, we will need you to pay a [commuted sum](#) to cover the excess maintenance costs of most alternative materials and surfaces. Table MC9 is a guide to indicate the types of materials you will have to pay a commuted sum for. Please also see [Section MC18](#) for further details on our commuted sums policy.

Table MC9: Alternative footway, cycleway and hard paving surfaces and commuted sum requirements

Normal alternative surfacing materials ^(a)	Commuted sum payable?
Surface dressing using locally-sourced granite aggregate chippings	No
Surface dressing using crushed rock aggregate from a specific non-local source	Yes
Surface dressing using pea gravel aggregate from a local source	Yes
Surface dressing using pea gravel aggregate from a non-local source	Yes

The 6Cs Design Guide

Surface dressing using crushed gravel aggregate from a local source	Yes
Surface dressing using crushed gravel aggregate from a non-local source	Yes
Hot or cold applied coloured surfacing (resin system)	Yes
Standard surface course materials using a coloured binder and coloured aggregate or chippings	Yes
'Imprint' or other similar approved hot-applied, polymer-modified, synthetic bitumen-based compound, surface-applied block paving alternative finish	Yes
Standard 60mm concrete-block paving surface course	Yes
'Tegula' or similar approved concrete-block paving surface course	Yes

(a) We will be prepared to consider other materials not listed above, so long as, among other things:

- you meet the requirements listed in [paragraph 4.104](#);
- you can provide evidence of where the material has been used in similar circumstances and how durable it has been;
- the safe and satisfactory operation of the highway would not be threatened;
- accessibility is not threatened, including for pedestrians, cyclists and people with disabilities; and
- you pay a commuted sum where the future maintenance costs are greater than they would be if you used the more usual surfacing instead.

Widening existing footways, footpaths and cycleways

4.105 You must overlay or resurface full width any existing footway, footpath or cycleway that is widened, unless we agree otherwise.



Section MC 12: Traffic signs, road markings, studs and traffic signals

- [General](#)
- [Traffic regulation orders](#)
- [Public consultation](#)
- [Traffic signs](#)

The 6Cs Design Guide

- [Changes to original road layout](#)
- [The electricity supply to illuminated traffic signs](#)
- ['Bulk clean and lamp change' charges](#)
- [Road markings](#)
- [Street name plates](#)
- [Road studs](#)
- [Traffic signal equipment](#)

General

4.106 All traffic signs you use (including bollards, retro-reflecting road studs and road markings), whether permanent or temporary, must be the size, shape, colour and type prescribed in [The Traffic Signs Regulations and General Directions 2002 \(Statutory Instrument 2002 No. 3113\)](#), the [Zebra, Pelican and Puffin Pedestrian Crossings Regulations and General Directions 1997 \(Statutory Instrument 1997 No. 2400\)](#) and any later amendments. Other relevant requirements are included in the above Regulations and General Directions.

Traffic regulation orders

4.107 Traffic regulation orders (TROs) are required for cycleways and may be required for footpaths, to stop motor vehicles or cyclists using them. They may also be required for certain traffic signs and road markings. The successful making of an order is not guaranteed. But, you must pay any costs we incur in making these orders or alterations to existing orders, whether or not the order is successfully made. Our [information leaflet](#) provides further details on TRO procedures.

Public consultation

4.108 Before we make a TRO we have to carry out a public consultation. This gives members of the public the opportunity to raise objections. Because of this, the time it takes to complete the process can vary. You must pay any costs we incur carrying out these consultations. We also have to carry out public consultations for traffic-calming and other works on the existing highway. You are responsible for the cost of these consultations also. The successful outcome of consultations is not guaranteed, but you must still pay our costs even if there is not a successful outcome.

Traffic signs

4.109 You must show the details of individual traffic signs, including their posts and foundations, on the traffic sign schedule sheets included in Appendix 12/1 of our [Specification](#). These must comply with Appendix 12/1 of our Specification and the [standard drawings](#).

Changes to original road layout

4.110 You must provide signs to diagram 7014 of the [Traffic Signs Regulations and General Directions 2002](#) using the appropriate permitted variant on all approaches to a permanent alteration to the original road layout as soon as it is brought into use. You must maintain these signs for three months and remove them at the end of that time.

The 6Cs Design Guide

The electricity supply to illuminated traffic signs

4.111 Most illuminated signs are to be fed by an electricity company supply. However, certain signs must be fed by a highway authority private supply, for example, a bollard on a traffic island in the middle of the road.

4.112 Your layout plan must show the location of all signs and bollards that need illumination so that we can identify the requirements for the electrical supply. We will incorporate these requirements into the street-lighting design we will provide for you.

4.113 You are responsible for:

- arranging for the [electricity company](#) to provide the electricity supply to the illuminated signs or arranging for a highway authority private supply;
- providing test certificates in accordance with [BS7671](#); and
- paying for all aspects of the works including paying energy charges and maintenance of the illuminated signs before we issue the final certificate.

'Bulk clean and lamp change' charges

4.114 Before we issue the final certificate of completion, you must pay us the cost of a 'bulk clean and lamp change' of all illuminated signs and bollards. We will include the cost of this in the bond figure.

Road markings

4.115 You must provide road markings in accordance with the [Traffic Signs Manual Chapter 5](#) and the [Traffic Signs Regulations and General Directions 2002](#).

4.116 You must show the location, colour and type of permanent road markings on your drawings.

4.117 The markings must comply with Appendix 12/3 of our [Specification](#).



Street name plates

4.118 You are required to apply to the [district council](#) as the street-naming authority for names to be given to any new lengths of road. The district council will specify the details that they require, and you may be able to submit suggested names for consideration.

4.119 The district council will advise you of the names chosen, following the necessary consultations. It is your responsibility to erect the street name plates which the district council has chosen.

4.120 Any street name plates on [private drives](#) or unadopted 'roads' should clearly state that drive is 'private' or the road 'unadopted'.

The 6Cs Design Guide

Road studs

4.121 You must:

- provide road studs in accordance with the [Traffic Signs Manual, Chapter 5](#);
- show the locations and positions of road studs on your drawings;
- use road studs that comply with Appendix 12/3 of our [Specification](#); and
- use stainless steel non-reflective road studs at pedestrian, cyclist and equestrian crossings to form marks as shown in diagrams 1055.1 and 1055.2 of the [Traffic Signs Regulations and General Directions 2002](#).

Traffic signal equipment

4.122 We will normally design the traffic signals within the highway works based on detailed road layout drawings you have supplied.

4.123 We will normally supply and install all permanent traffic-control equipment to be installed as part of the highway works. You must pay the reasonable cost to us for designing, supplying and installing the equipment.

4.124 You must normally pay us a [commuted sum](#) towards the future maintenance of the traffic-signal equipment. Please also see [Section MC18](#) for further details on our commuted sums policy.

4.125 You must allow us access at all reasonable times to any part of the site on which cables, pipes, ducts or other apparatus associated with the traffic-signal equipment is to be installed or is located so we can carry out any works we need to do to install and maintain the cables, pipes ducts or other apparatus.



Section MC 13: Street lighting

- [General](#)
- ['Bulk clean and lamp change' charges where adoption is delayed](#)
- [Alternative 'heritage' street lighting](#)

General

4.126 After we have issued technical approval for your highways works (for Section 38 works see [Part 5, Section ANR4](#) and for Section 278 works see [Part 6, Section WEH4](#)), a street-lighting design must be provided in accordance with:

- [BS5489](#); and
- the Highways Agency [Specification for Highway Works](#), Series 1300 and 1400.

The 6Cs Design Guide

Please contact the relevant highway authority for further details on their procedures and the design service that they provide. [Appendix A](#).

For example, Leicestershire County Council's Highways Development Control Group will contact our street-lighting section directly, you do not need to approach them independently. As well as providing a layout plan, Leicestershire County Council's street-lighting section will provide the specification of the equipment to be installed and a designer's risk assessment (these items together are known as the 'data sheet')

4.127 You are responsible for:

- ensuring that the street lighting design is undertaken; (please contact the relevant highway authority for further details on their procedures and the design service that they provide [Appendix A](#).)
- ensuring that the specification of equipment is in accordance with the 'data sheet' that we issued for the lighting scheme;
- marking the exact position of the street lights on site for the street-lighting contractor;
- arranging for the electricity company to provide the electricity supply to the street lights;
- providing test certificates in accordance with [BS7671](#); and
- paying for all aspects of the works including paying energy charges and maintenance of the street lights before we issue the final certificate of completion.

'Bulk clean and lamp change' charges where adoption is delayed

4.128 **Section 38 agreements:** If there is more than three years between:

- beginning the work and issuing the final certificate; or
- completing the section 38 agreement and issuing the final certificate;

you will have to pay the cost of a 'bulk clean and lamp change'. We will include the cost of this in the bond figure.

4.129 **Section 278 agreements:** If there is more than two years between:

- beginning the work and issuing the final certificate; or
- completing the section 278 agreement and issuing the final certificate;

you will have to pay the cost of a 'bulk clean and lamp change'. We will include the cost of this in the bond figure.

The 6Cs Design Guide

Alternative ‘heritage’ street lighting



4.130 The street lighting specification we provide will use ‘standard’ galvanised steel columns with road-lighting lanterns of the appropriate height and wattage. However we do have a limited range of “heritage” street-lighting columns and lanterns which you can specify as long as you pay a [commuted sum](#) to cover the increased costs of maintenance and replacement associated with this type of equipment. Please also see [Section MC18](#) for further details on our commuted sums policy.

4.131 If you want to request this option, you should tell us when you submit layout drawings for technical approval. This will allow us to establish information about commuted sums and styles of lighting columns before we design the street lighting.



Section MC 14: Street furniture and street art

General

4.132 It is important to establish at an early stage (and certainly before any-planning application) what street furniture and so on is proposed within areas that are intended to be [adopted](#) as publicly-maintained highway, and who would be responsible for it. You may need to include this as part of a concept proposal that you are required to prepare for your proposed development. (Please see [Part 2, Section PDP4](#) for further information on concept proposals).

4.133 Table MC10 sets out details of who would normally accept future responsibility and whether or not a [commuted sum](#) is payable. You must confirm that you have reached agreement with the organisations concerned before we can agree to your proposals.

The 6Cs Design Guide

Table MC10: Future maintenance responsibilities and commuted sum requirements

Item of street furniture and so on	Organisation normally responsible for future maintenance	Commuted sum payable?	Formal agreement required between responsible body and us
Bollards	HA	Yes	N/A
Knee-rail fencing	HA	Yes	N/A
Seats	TC/PC ^(a)	N/A	Yes
Cycle stands	HA	No	N/A
Bus-stop poles and flags	HA	No	N/A
Bus shelters	TC/PC ^(b) ; DC/BC/HA ^(c) (d)	Yes	Yes
Bus gates	HA	Yes	N/A
Planters and raised beds	TC/PC	DC/BC ^(b) /HA ^(c)	Yes
Tree grills	HA	Yes	N/A
Street art	TC/PC	N/A	Yes
Village and town features	TC/PC	N/A	Yes
Memorials and commemorative items	TC/PC	N/A	Yes
'Heritage' direction signs	HA	Yes	N/A
Flagpoles and similar structures	TC/PC	N/A	Yes
Information boards	Depends on information	If HA responsible	Yes
Litter bins	DC/BC	N/A	Yes
Dog-litter bins	DC/BC	N/A	Yes

Key:

HA = highway authority (us); DC = district council; BC = borough council; TC = town council; PC = parish council.

(a) Where no town or parish council exists, responsibility for items normally maintained by the town or parish council will generally pass to the district or borough council.

(b) Organisation normally responsible.

(c) Alternative organisation who may accept responsibility.

(d) Please contact the relevant highway authority to discuss their requirements for undertaking responsibility for future maintenance. For example, Leicestershire County

The 6Cs Design Guide

Council will generally only assume responsibility for bus shelters if they are provided on a County Council 'route development' route.



Section MC 15: Highway structures

- [Definition](#)
- [Design](#)
- [Supervision of the construction](#)
- [Fees](#)
- [Adopting structures](#)

Definition

4.134 Highway related structures will normally include the following:

- bridges;
- tunnels;
- retaining walls;
- corrugated-steel buried structures;
- reinforced soil and anchored earth structures;
- reinforced clay brickwork retaining walls of pocket-type and grouted-cavity construction;
- crib wall retaining walls of concrete or timber construction;
- environmental barriers (including noise barriers and fencing); and
- all drains, piped and box culverts, sewers and drainage structures, other than bridges, that have a diameter or clear span of more than 900mm.

4.135 A highway related structure can fall into one of three types, either:

- any structure built in, under, or over, the highway; or
- any retaining wall or structure which supports the highway and where the distance between the highway boundary and the rear face of the wall or structure is less than twice the difference in level between the ground at the front of the wall and the highest level of the adjacent highway at any point along the length of the wall or structure; or
- any retaining wall built within 3.65m of the highway boundary where the retained height above the adjacent highway is 1.4m, or more.

Note: The definition of 'highway' used above includes the carriageway, footway and all verges.

The 6Cs Design Guide

Figure MC4 Highway related structures

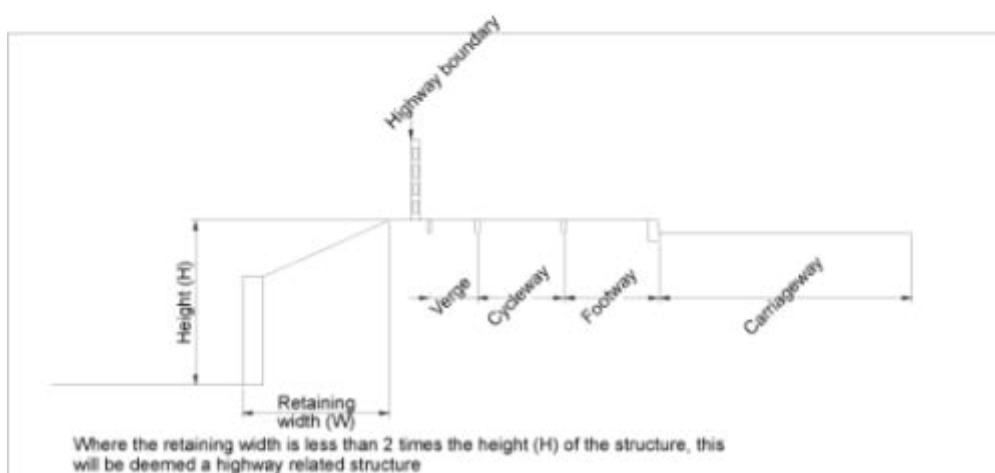
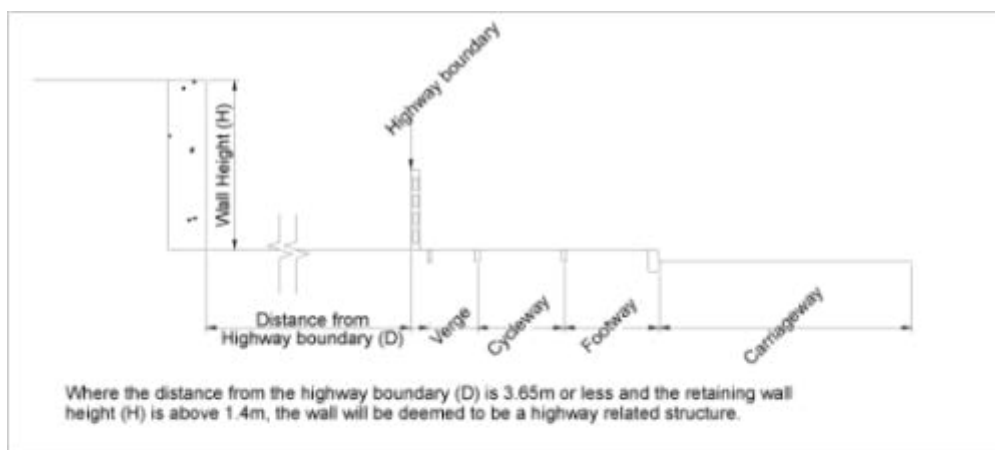

Design

4.136 All highway related structures, whether we are to [adopt](#) them or not, must be designed and constructed in accordance with the current relevant Highways Agency standards, codes of practice and technical memoranda. The design will be subject to the technical-approval procedure set out in the Department of Transport Standard BD 2/12 “Technical Approval of Highway Structures on Motorways and Trunk Roads” ([Highways Agency Design Manual for Roads and Bridges](#) Vol. 1 Sect. 1 Part 1), except that the Technical Approval Authority will be the relevant highway authority.

4.137 You must employ a chartered civil or structural engineer with experience in highway structures and approved by the relevant highway authority to carry out the design and oversee construction.

Supervision of the construction

4.138 The construction must be carried out under the direction of an independent chartered civil or structural engineer, approved by us, and with substantial experience of the construction of highway structures.

4.139 Before construction begins, you must provide a programme of supervision for our approval. The programme must give details of the level and amount of supervision that will

The 6Cs Design Guide

be provided so we are confident that the structure will be built in accordance with the design and specification. The programme must also contain proposals for materials testing.

4.140 At regular intervals, we will audit the supervision of a scheme to make sure that you are meeting the agreed programme of supervision. However, it is the developer's responsibility to keep us informed of the proposed programme (4.139). Before adoption, you must give us copies of approved design calculations (if not already received), inspection certificates, material-testing certificates, digital photographs on CD (*.JPG or*.BMP format), as-built drawings preferably in an electronic form, (for example Autocad file) on CD, maintenance manuals and a Construction Compliance Certificate in accordance with Annex C6 of BD 2/05 'Technical Approval of Highway Structures' (Design Manual for Roads and Bridges). This information should be submitted in advance of a request for a final certificate of completion to the highway authority (full adoption certificate). Failure to accord to the approved design and insufficient collation of the required evidence will jeopardise the ability of the highway authority to adopt structures.

Fees

4.141 You will have to pay the additional design checking and inspection fees for any highway structure. This is charged at 'actual' rate and we will give you an indication of the likely fee at our earliest opportunity.

Adopting structures

4.142 There should be discussion at an early stage (and certainly before any-planning application) to agree which structures we are to adopt.

4.143 You must pay a [commuted sum](#) for future maintenance of any highway structure to be adopted. Please also see [Section MC18](#) for further details on our commuted sums policy.



Section MC 16: Soft landscaping and trees

- [General](#)
- [Considering existing features](#)
- [New feature design considerations](#)
- [Peat](#)

The 6Cs Design Guide

- [Applying pesticides](#)
- [Controlling weeds](#)
- [Landscaping and tree maintenance issues](#)
- [Adopting the landscape and trees](#)
- [Sponsorship](#)

General

4.144 Soft landscaping within highway areas can be as important in determining the character of the development and integrating it into its surroundings as landscaping elsewhere within the site. You should not underestimate how important it is to create an attractive environment. Planning authorities are unlikely to favour developments that lack quality design and layout.

4.145 You should prepare landscaping proposals at the pre-application stage so we can consider their suitability in good time and so the utility providers (for example gas, water, cable TV) can be consulted over the proposals. We must approve the landscaping proposals within the development whether or not they form part of a landscaping scheme which you have submitted to the planning authority for approval.

4.146 You should engage a chartered landscape architect to advise you and prepare landscaping proposals for the development.

4.147 While planting and trees can enhance the street scene, you must take care to make sure that building frontages and parking areas can still enjoy good natural observation from areas of potential activity such as roads and footways.

4.148 Soft landscaping must comply with Series 3000 and Appendices 30/1 to 30/10 of our [Specification](#).

Considering existing features

4.149 **Protecting and preserving existing trees:** Requirements for protecting and preserving existing trees are contained in [appendix F](#), 'The Preservation of Trees in Connection with Roadworks and New Development'.

4.150 **Existing boundary hedges and fences:** You must make it clear to purchasers of individual property at the time of sale that you are transferring ownership and responsibility for existing highway boundaries to them. The lack of maintenance and cutting back of hedges is a common problem for us, particularly where the hedge had enclosed farmland or had not been regularly maintained previously. If you erect new fencing to the inside of existing hedges and fences the purchaser may mistakenly believe that the original hedge or fence is our responsibility.

4.151 **Bird nesting season:** You must not remove or carry out work to existing or planted trees, shrubs, hedges and other vegetation during the bird nesting season. This is generally considered to be from March until the end of July but can cover a longer period. You should check for the presence of active nests outside that period.

The 6Cs Design Guide

New feature design considerations

4.152 **Preparing the ground:** You must prepare the ground of all areas to be grassed or planted in accordance with clause 3004 of the [Highways Agency Specification](#) and Appendix 30/4 of [our Specification](#).

4.153 **Grass seeding and turfing:** You must seed or turf grassed areas in accordance with clause 3005 of the [Highways Agency Specification](#) and Appendix 30/5 of [our Specification](#).

4.154 **Minimum grass verge and planting bed sizes:** Narrow grass strips between footways and carriageways and small isolated shrub beds are often neglected and over-run by vehicles. You will normally have to use hard paving in these locations. Normally you should provide a minimum width of 1m and minimum area of 10m² for grass and 1m and 6m² for shrub and ground-cover planting.

4.155 **Reinforcing verges:** Where it is necessary to reinforce verges to prevent erosion where vehicles are likely to be parked, including maintenance vehicles, you must use an approved system of reinforcement.

4.156 **Plants and planting:** All plants and planting works must be in accordance with clause 3006 of the [Highways Agency Specification](#) and Appendix 30/6 of [our Specification](#).

4.157 **Tree planting in grilles with guards within paved areas:** Trees within hard-paved areas should normally be planted in tree grilles with tree guards. These should normally be in accordance with the details included in Appendix 30/12 of [our Specification](#).

4.158 **Planting within visibility splays:** You must not normally plant new trees within any visibility splays (including at junctions and on bends). Only in exceptional circumstances will we permit existing trees to be retained, following an examination on site. Any new trees must be of a species we approve to make sure that they have slender trunks when mature and which are clear of side growth to a height of 2m and, when planted together, allow adequate visibility.

Figure MC5 Example of unacceptable tree planting in a visibility splay

Row of trees obstructing driver's view on the approach to the junction

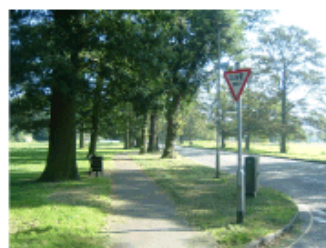
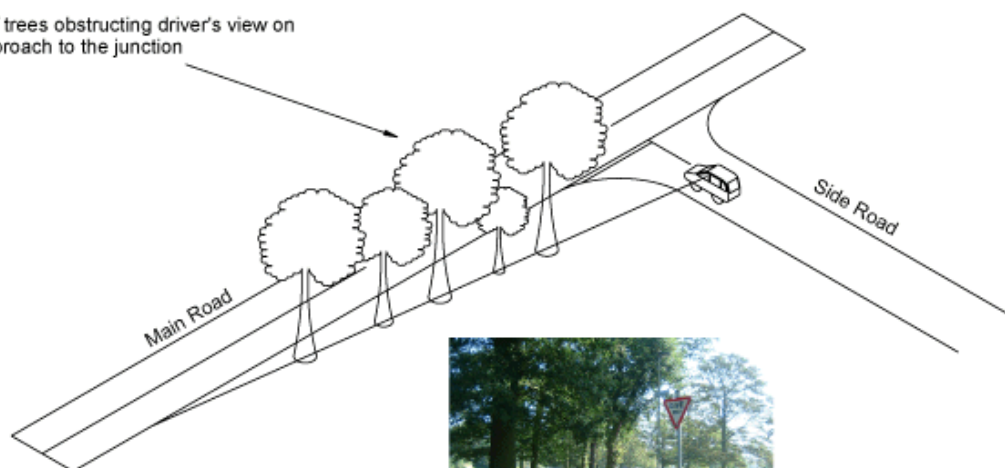

Typical driver's eye view

The 6Cs Design Guide

4.159 Any landscaping (planting, shrubs and so on) within visibility splays should not normally be expected to grow to more than 600mm in height above the adjacent carriageway level where the carriageway gradient is level. We will assess planting in locations where the carriageway is on a slope or there are crests or sags in its vertical alignment, on a site-by-site basis.

4.160 **Additional information about landscape planting:** Additional information on landscaping, including choice of species, is contained in appendix G, 'Landscaping on New Developments and in Highway Improvement Schemes'.

Peat

4.161 You must not use peat or peat-based products except where peat is excavated on the site.

Applying pesticide

4.162 All pesticides, methods of application, materials and tank mixes, methods of working, transportation, storage and records must be strictly in accordance with current legislation and codes of practice and also in accordance with clause 3001 of the [Highways Agency Specification](#) and Appendix 30/2 of [our Specification](#).

Controlling weeds

4.163 You must control weeds in accordance with clause 3002 of the [Highways Agency Specification](#) and Appendix 30/2 of [our Specification](#).

Landscaping and tree maintenance issues

4.164 **Maintaining existing trees, shrubs and hedges:** All existing trees, shrubs and hedges that are to be retained within the existing highway or areas to be [adopted](#) must be maintained in accordance with clause 3010 of the [Highways Agency Specification](#) and Appendix 30/10 of [our Specification](#) until the issue of the [final certificate](#). This includes any required arboricultural work including tree surgery.

4.165 **Establishing and maintaining new landscape planting:** Planted landscaping areas, trees, shrubs and so on that we are to [adopt](#) must be fully planted before we issue a [provisional certificate of completion](#). This planting must be maintained until the issue of the final certificate, including any necessary replacements for whatever reason, to make sure that it is fully established.

4.166 Maintenance of such planting must be in accordance with clauses 3008 and 3009 of the [Highways Agency Specification](#) and Appendices 30/8 and 30/9 of [our Specification](#).

4.167 **Grassed areas:** You must satisfactorily maintain any existing grass areas and satisfactorily establish any new grassed areas before we will issue you with a provisional certificate. You must maintain grassed areas throughout the maintenance period and until issue of the [final certificate](#) in accordance with clause 3007 of the [Highways Agency Specification](#) and Appendix 30/7 of [our Specification](#).

Adopting the landscape and trees

4.168 Areas we are prepared to [adopt](#) as highway should preferably be concentrated into larger areas, to provide economies of scale and to avoid small or remote areas which are

The 6Cs Design Guide

difficult to maintain. Small and remote areas can actually result in the very opposite of what is intended of creating an attractive and well-cared-for environment.

4.169 Generally, you should lay out verges, embankments and other areas of open space forming part of the adoptable highway as amenity grass areas unless we agree to some other form of landscaping to help enhance the quality and appearance of a development. You will have to pay us a [commuted sum](#) where we are to take on the maintenance of such landscaping where it falls within an existing or proposed area of highway. As an alternative, the district, town or parish council may agree to maintain the planting under a license granted under Section 96 of the Highways Act 1980.

4.170 In general, we will accept responsibility for new or retained trees we have approved if you pay a commuted sum towards future maintenance and inspection costs.

4.171 Public open spaces, including amenity open spaces and children's play areas, will normally be adopted by the district, town or parish council.

4.172 We will only normally consider adopting an area of open space that:

- is next to but not an essential part of the adoptable highway;
- is not going to be adopted as public open space by the district, borough or parish council;
- cannot be designed out; and
- may not be safely and satisfactorily maintained if it becomes part of the adjacent property.

4.173 You will need to pay us a [commuted sum](#) for any such open space we adopt. Please also see [Section MC18](#) for further details on our commuted sums policy.

Sponsorship

4.174 We may allow you to enter into a sponsorship agreement for maintaining of certain landscaped areas either direct with us or with a town, parish, borough or district council where a maintenance agreement with that council exists.

Section MC17: Noise barriers, screening and bunding

4.175 You should design environmental barriers, including earth mounds, associated planting and noise barriers in accordance with HA 65/94 and HA 66/95 'Design Guide for Environmental Barriers' ([Highways Agency Design Manual for Roads and Bridges](#) Volume 10 Section 5 Parts 1 and 2).

4.176 Where your proposal includes earth mounds and any associated landscape planting and noise barriers, you must clarify and agree details of ownership and arrangements for future maintenance at an early pre-application stage.

4.177 Purchasers of individual dwellings are unlikely to accept ownership and responsibility for environmental barriers. This is because maintenance liability is often beyond the means of the individual. If environmental barriers are transferred to purchasers of individual dwellings you must make this clear to purchasers at the time of sale and include such details in conveyances.

The 6Cs Design Guide

4.178 In general, the district, town or parish council will be expected to [adopt](#) and maintain earth mounds and any associated landscape planting and noise barriers. We may consider [adopting](#) these areas if you pay a [commuted sum](#). Please also see [Section MC18](#) for further details on our commuted sums policy.

4.179 Where we agree to environmental barriers within existing highway limits, you must pay a commuted sum.

4.180 Unless we agree otherwise, we will treat noise fencing as a highway structure and it will be subject to the design requirements, design checking and inspection fees and commuted sums for future maintenance required for highway structures. (Please see [Section MC15](#) for further information on highway structures).

Figure MC6 Example of noise fencing



Section MC18: Commuted sums and how we calculate them

- [Background](#)
- [Application](#)
- [Calculating commuted sums](#)
- [Maintenance unit costs \(Mp\)](#)
- [Discount rate \(D\)](#)
- [Time period \(T\)](#)
- [Schedules of commuted sums payable](#)
- [Calculating the actual commuted sums to be paid](#)
- [Bonding commuted sums](#)
- Timing of payments

4.181 In this Section we set out the basis of payment and how we calculate [commuted sums](#) you must pay us towards the cost of maintaining certain [adoptable](#) highway infrastructure provided for new developments.

The 6Cs Design Guide

Background

4.182 The legal basis: Circular 1/97 Planning Obligations refers to the payment of commuted maintenance sums where specifically provided for in legislation (the [Highways Act 1980](#)).

4.183 Section 38 of the [Highways Act 1980](#), sub-section (6) provides for paying expenses to us for maintaining any highway, road, bridge or viaduct covered by an agreement made under that section.

4.184 Section 278 of the [Highways Act 1980](#), sub-section (3) provides for you (the other party to the agreement) making payments to us for maintaining the works the agreement relates too.

4.185 Regional discussions and agreement: Because there is no national guidance at present, the Midlands Regional Service Improvement Group – Development Regulation, has sought to reach agreement on applying and calculating commuted sums to achieve a consistent approach throughout the region. There has been a high level of agreement on this between the highway authorities concerned. We have adopted the generally-agreed application and method of calculation.

Application

4.186 The need for paying commuted sums can be divided into four broad categories.

(a) The cost of maintaining areas and construction which, under our normal design guidance given in [Part 3](#), are not required for the safe and satisfactory functioning of the highway. Examples are additional areas of carriageway, such as a 'square' surrounding a turning head (see figure MC7a), hard landscaping, grass verges (see figure MC7b) and so on.

Figure MC7a Example of turning head within a 'square'

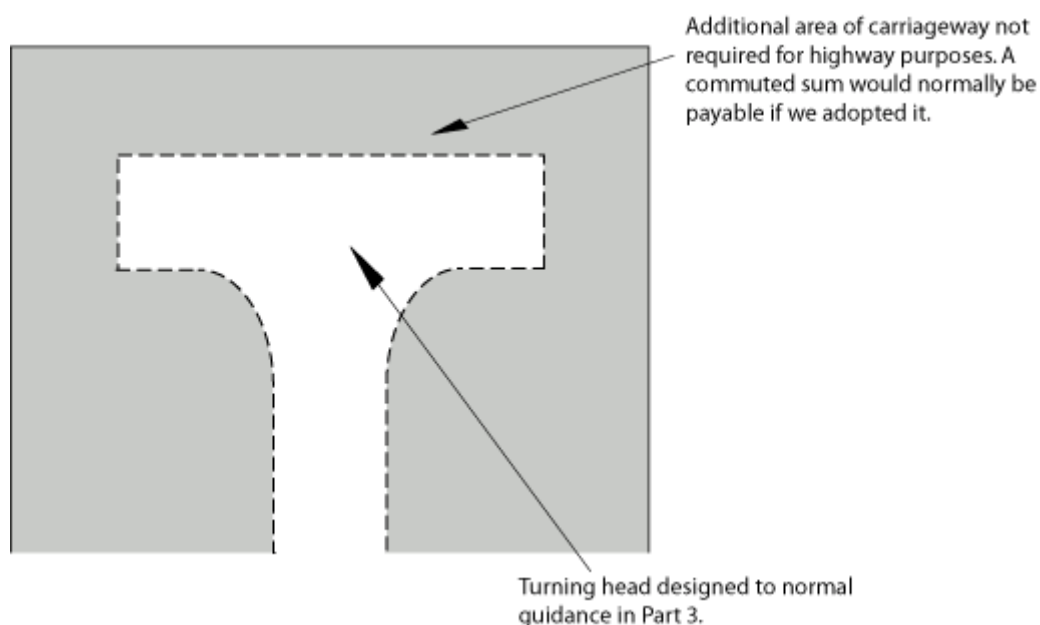

The 6Cs Design Guide

Figure MC7b Example of additional area of grass verge adopted under a commuted sum

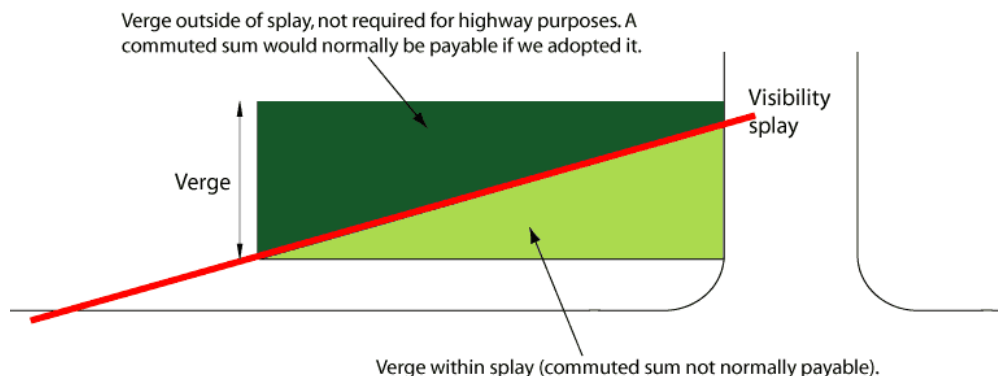

Under this category you may need to pay commuted sums for:

- new [adoptable](#) highways generally constructed under S38 agreements, if any additional areas and construction which result from the overall development layout design, are over and above what we would normally require to satisfy safety and operational requirements; and
- alterations to existing highways, carried out under S278 agreements, which are required only to serve the development and provide no general benefits. We will consider individual cases on their merits where there is some general benefit. We will not normally require a commuted sum where the alterations have already been programmed for construction.

(b) The cost of maintaining some features of the adoptable works which can be considered as extra over. Examples include highway structures, public transport infrastructure, landscaping, trees, shrubs and so on, additional or non-usual street furniture and noise fencing.

- These costs represent an increase in our future maintenance liability which will be more than the anticipated normal funding generated by the development.

(c) The additional cost of maintaining permitted alternative materials and features which are extra over. Examples include surfacing materials and street lighting equipment.

- These additional costs are in excess of what we would have incurred if the materials and features used had been to the standard Specification.

(d) Sustainable drainage systems (SUDS), for example, flow-attenuation devices, swales and storage areas.

Note: Where you are proposing SUDS, you must hold discussions with all relevant parties at an early stage (and certainly before any planning application) to agree ownership and responsibility for the facility.

This is not an exhaustive, detailed list. It is only intended to illustrate broad principles. Cases where commuted sums will normally be required are set out in other parts of this

The 6Cs Design Guide

document. You should always discuss with us where commuted sums might be required at the earliest possible opportunity and certainly before any planning application.

Calculating commuted sums

4.187 We work out the cost your maintenance obligation using this formula:

$$\text{Commuted sum} = \sum Mp / (1 + D/100)^T$$

Mp = Estimated periodic maintenance cost

D = Discount rate (effective annual interest rate) (%)

T = Time period before expenditure will be incurred (years)

Maintenance unit costs (Mp)

4.188 Maintenance unit costs are based on contract rates current at the time of calculation and the frequency of treatment or intervals of replacement, based on planned frequencies or historic information. A sum of 10% of the works costs will be added to cover our design and supervision costs.

Discount rate (D)

4.189 The discount rate (effective annual interest rate) is worked out as follows:

$$\begin{aligned} D &= (1.045/1.0225) - 1 \\ &= 2.2\% \end{aligned}$$

where 1.045 is the interest rate (4.5% based on long-term neutral base rate)
1.0225 is the inflation rate (2.25% based on RPI-X that is RPI excluding mortgage payments)

Time period (T)

4.190 There is a case for using a time period equal to the expected life of the development in the case of development roads. However, for the time being, a time period of 60 years (maximum) will be used to calculate the commuted sums, with the exception of highway structures when a 120-year period will apply, in accordance with the standard design life requirement. The 60 year period reflects the recommendation of the CSS publication 'Commuted Sums for Maintaining Infrastructure Assets'.

Schedules of commuted sums payable

4.191 You can find schedules of commuted sums for various additional areas, additional features, and alternative surfaces and specifications in [Section MC19](#). We will add other commuted sums values and additional items as the need arises. The commuted sums in the schedules have been calculated at a particular date as indicated and will need to be index-linked to the date of the agreement. We will calculate some commuted sums specifically for certain sites.

The 6Cs Design Guide

Calculating the actual commuted sums to be paid

4.192 You will be required by the relevant agreement with us to pay us a commuted sum. However, we may not know the full cost implications of the site at that stage. So, we will calculate the final commuted sums value immediately before we [adopt](#) the development. This will be based on the 'provisional' commuted sums agreed when we complete the agreement. The agreement will contain provision for recalculating the 'provisional' commuted sums based on actual quantities and a price fluctuation factor specified in the agreement.

Bonding commuted sums

4.193 Any commuted sums you must pay will be included in the bond required under the Section 38 or Section 278 agreement. This will be based on the 'provisional' commuted sums that we calculate when we complete the agreement.

Timing of payments

4.194 The commuted sum will be payable before we issue the final certificate.

Section MC19: Schedules of commuted sums for maintenance of works under Section 38 and Section 278 agreements

4.195 Where no figure is shown, we will calculate as the need arises. N.B Please be aware that the rates detailed [here](#) are based upon the existing 60 year calculation period.

4.196 For Section 278 works we will not normally apply commuted sums for the existing area of carriageway unless it is a non standard material (in that case the commuted sum would be the difference between the commuted sum for the standard and non-standard material). A full commuted sum would be required for any additional carriageway created (e.g. right turn lane), or any new feature created (e.g. refuge/splitter island, additional lighting, bollards etc). This is because the additional carriageway and features created above those existing are only required to provide the access for the new development, and therefore it is reasonable to require a commuted sum to maintain them in the future.

The 6Cs Design Guide

Part 5: Adopting new roads and the advance payments code

Section ANR1: Introduction

General

5.1 This part deals with building new roads within development sites (please see Part 6 for works on existing roads). It covers our requirements and procedures for managing the advance payments code and for adopting a road that you construct as publicly-maintained highway. It covers:

- what you must do when we serve you with an assessment under the advance payments code for the cost of roadworks;
- how we refund money paid or secured under the advance payments code;
- technical details, including drawings and details of any safety audits required before we can approve your proposed roadworks for both adoptable roads and roads to remain private;
- a Section 38 legal agreement, which provides for us to adopt your road;
- you constructing and maintaining the road works before we adopt them; and
- our fees and other payments relating to the construction and adoption of the road.

5.2 You should involve both us and the planning authority in consultations at an early stage of preparing your development proposals. This applies especially if the proposed layout is not explicitly covered by the guidance in this document or is for, or contains, a Home Zone. This will provide an opportunity to resolve any potential problems about adopting your road before you submit any planning application.

5.3 We will normally encourage developers to create, whenever possible, 'road' layouts that are to an adoptable standard and that will be offered for adoption for:

- residential developments of more than five dwellings; and
- multiple-building, multiple-occupation industrial and commercial developments (developments occupied by more than one company).

We will consider other forms of development on a site-by-site basis.

5.4 Please see:

- Part 3, Sections DG2 for design guidance on adoptable residential and commercial roads;
- DG18 for guidance on private residential developments
- DG19 for guidance on industrial and commercial developments.

The 6Cs Design Guide

Notes:

- Wherever 'the Act' is mentioned in this part, it refers to the Highways Act 1980 unless otherwise stated.
- The Region provide a range of design and construction services. Please click here for more information.

About Sections 219 to 225 of the Act

- 5.5** Under Section 219 of the Act, we have to assess the cost of the roadworks fronting new buildings on private roads and secure payment of these costs. This makes sure we can complete the new road to a satisfactory standard if you (the developer) fail to do so. It also makes sure that those who live on the road will not be liable to complete it.
- 5.6** Unless your proposals are exempted (see Appendix J) we will serve you with a notice of assessment detailing the costs associated with each building.
- 5.7** The advance payment code applies to all private roads which are not exempted, even those intended for adoption. We monitor all sites where we have served a notice of assessment which has not been paid or secured. If you start work on any building which has an unpaid or unsecured assessment, you will be committing an offence, and we may take you to court.
- 5.8** For details on how to get your advance payments code assessment refunded, please see Section ANR2.

About Section 38 of the Act

- 5.9** Section 38 of the Act provides for us to take over and maintain at public expense (adopt) a road that you have constructed. The adoption process is covered by a Section 38 agreement.
- 5.10** Section 38(6) of the Act says: *“An agreement under this section may contain such provisions as to the dedication as a highway of any road or way to which the agreement relates, the bearing of the expenses of the construction, maintenance or improvement of any highway, road, bridge or viaduct to which the agreement relates and other related matters as the authority making the agreement think fit.”*
- 5.11** This section of the Act entitles us to seek expenses for maintenance and we intend to do this through commuted sums. This will allow us greater flexibility to adopt non-standard layouts and materials without placing undue burdens on our maintenance budget or council taxpayers. However, even if you offer a commuted sum payment, we may still resist adopting the proposed layout if we consider it to be inappropriate or unacceptable on highway-safety grounds. (Please refer to paragraph 5.72 onwards for further details on commuted sums.)

Section ANR2: Our advance payment code procedures

The assessment notice

- 5.12** Unless your proposals are exempted (see Appendix J) we will serve you with a notice of assessment detailing the costs associated with each building. By law, you have to pay the amount set out in the notice. We can take you to court and fine you if you start your development without paying first.

The 6Cs Design Guide

- 5.13** You can pay the assessment amount by cheque or cash, or we will accept a bond in some circumstances.
- 5.14** Once you have paid or secured your advanced payment code assessment, there are two ways you can have it exempted and your money refunded or your security cancelled.
- You can enter into a Section 38 road agreement (see Sections ANR3 onwards).
 - You can finish the works to a standard that we judge will provide a durable road construction with the likelihood that only reasonable future maintenance will be needed.

Our design and construction requirements

- 5.15** If the road is to remain private you will need to:
- agree a construction specification and submit plans for technical approval;
 - get our approval for your plans and pay our administration and inspection fee; and
 - notify our inspector at each major phase of construction so they can inspect the works.
- 5.16** For a non-adoptable road the drawings you submit for approval should show:
- the layout and construction of the road to meet the conditions of Part 3 DG18;
 - the private-road signs erected where they do not block any visibility requirements, level with the back of the public highway, with the exact location to be agreed with the Inspector;
 - the boundary with the public highway, typically a flush kerb in the carriageway, changes in surfacing materials or any other agreed alternative;
 - the access onto the highway including gradients (generally no more than 1:10) and visibility splays;
 - details of surface water drainage showing that it does not run onto the public highway; and
 - any additional site-specific details and requirements of the planning permission.

When the works are completed

- 5.17** When the road has been constructed to our satisfaction, we will serve an exemption notice under Section 219 (4e) of the Act. We will refund the advanced payment code assessment in full, with interest if appropriate, or we may cancel the bond. You should note that completing this process does not mean that the road will be of an adoptable standard, in which case it will remain private and we will not maintain it at public expense.
- 5.18** Before we grant any exemption of the advanced payment code assessment, we will need to be indemnified (insured) against any future petition to adopt the road under Section 37 of the Act at a later date. This should be done by including a covenant in the deeds of sale to each plot fronting the private road. Our Legal Services section will approve the wording of the proposed covenant before it is put in place.

The 6Cs Design Guide

Our fees

- 5.19** We will charge for the work involved in checking and approving your plans, and inspecting the works on site. You should contact the respective Authority to establish the appropriate fee which varies across the Region.

More information

- 5.20** For more information about the advanced payment code procedure, see Appendix J.

Section ANR3: General requirements for entering into a Section 38 agreement

- 5.21** Before you can enter into a Section 38 agreement:

- you must obtain full planning permission for the development from the planning authority. This must include approval of any reserved matters relating to the road works; and
- you must prove title to the land to be dedicated as public highway within the agreement.

- 5.22** You will also need to prove a right to discharge surface water from the highway to an existing sewer, a proposed sewer or a water course. We will require proof that your drainage proposals have been approved by the relevant authorities.

- 5.23** You will need to give us the approved details of all necessary easements before we sign the agreement.

- 5.24** If the highway water discharges into sewers containing roof or yard water (or both), the relevant water company (which is either Severn Trent or Anglian or Yorkshire water in the Region) must approve the proposals and they must be included in a Section 104 agreement of the Water Industry Act 1991. We will **not** sign a Section 38 agreement before you have received a 'letter of intent' from the water authority that the drainage proposals are suitable for including in a Section 104 agreement.

- 5.25** We will adopt only drains laid for the sole purpose of discharging surface water from the highway. However, you must also get consent from the Environment Agency or the water company for its discharge and we will require proof of this before entering into a Section 38 agreement. We must approve proposals for highway drainage, including calculations of surface water run-off. Highway drainage will then be included within the terms of the Section 38 agreement for future adoption.

Section ANR4: Designing your road works

- 5.26** You should normally design your road works in line with Parts 3 and 4 of this document and our Specification. Our standard conditions applying to highway works for new development provides additional advice, for example on utility equipment (such as gas, water, electricity, and so on). If you have not carried out development in the Region before, you should first read Parts 1 and 2.

The 6Cs Design Guide

5.27 You will also normally be required to submit safety audits where:

- the layout contains features which are not explicitly covered by this design guidance or is not covered in any other way by this document; or
- the proposal is for, or contains, a Home Zone.

5.28 Where a layout contains features not explicitly covered by this design guidance or is for, or contains, a Home Zone you must provide a design statement for the safety auditor to support the proposed layout. The statement must cover:

- design speed;
- justification of visibility splays;
- service corridors and future maintenance practicalities;
- access for service vehicles including tracking;
- on-street parking;
- pedestrian routes;
- entry treatments for Home Zones; and
- implications for people with disabilities.

5.29 Safety audits must be carried out by an accredited safety audit team that is independent from the designers.

5.30 You will be responsible for commissioning and paying for all safety audits. Please see appendix D for further information on safety audits.

Section ANR5: Obtaining our approval for your road works

5.31 Each Authority in the Region has its own Act of Parliament that requires the owner of land on which a new street is to be constructed, or the person who holds the planning permission for this development, to obtain our approval as the Street Works Authority to plans, sections and other details of the level, width and specifications for the proposed street (including the sewers and drains) before any construction work is done.

5.32 Before carrying out any technical approval checks, we will require payment of our costs for any checking of the design and for preparing the Section 38 agreement in case the development does not take place. If you enter into the Section 38 agreement, we will deduct this from our administration and inspection fees.

5.33 We must approve your design consultant.

5.34 As soon as possible after stating that you want to enter into a Section 38 agreement, and before you have started to construct your road works, you must send us all the relevant information in line with the standard checklist we have given to you. When you have supplied all the information we need, we will carry out all the necessary design checks.

5.35 Where required you must satisfactorily complete the stage 1 and stage 2 safety audit processes and make all changes that we require before we will approve your proposed road works. (Please see paragraphs 5.58 and 5.62 regarding stage 3 and stage 4 safety audits)

The 6Cs Design Guide

5.36 We will only issue a technical approval when:

- we have completed all design checks;
- stage 1 and 2 safety audit processes have been satisfactorily completed where required; and
- you have supplied any additional or amended details we require.

However, the issuing of technical approval alone does not mean that you can start to construct the works. There are other matters which need to be addressed as set out in Section ANR7.

Section ANR6: Completing the legal requirements

The Section 38 agreement

5.37 After we have granted technical approval, you must provide 13 coloured copies of the drawing to be included in the Section 38 agreement and 2 uncoloured copies of all other details. These drawings are required for completing the legal agreement, inspecting the works, providing a street-lighting scheme and for search purposes.

5.38 You must colour the drawings as follows:

- carriageway – grey
- footways, footpaths, cycleways and other hard-surfaced areas – yellow
- shared-surface roads – brown
- traffic-calming features – brown
- verges – green
- highway drainage – blue
- additional highway structures – pink
- special surfacing – purple
- private drives that have had Advance Payment Code notices served – orange.

5.39 We will prepare all documentation for the Section 38 agreement. Details to be provided at this time include:

- the name and address of the landowner;
- your name and address as the developer;
- the name and address of any bondsman;
- the name and address of the solicitor;
- proof of ownership of the land; and
- proof of an intention to enter into a Section 104 agreement and any deeds of easements.

5.40 Our Section 38 agreements are in a standard format. However, at times it will be necessary to include various additional clauses for 'structures', 'commuted sums' and 'the need for individual licences for trees, benches, bins and so on within the proposed highway limits'.

The 6Cs Design Guide

5.41 We will charge you a fee for preparing the agreement. Please see Section ANR9.

The Construction (Design and Management) Regulations

5.42 Before we sign the Section 38 agreement, you must provide us with written proof that you have informed the Health and Safety Executive in writing that you are appointed client for the works for the purposes of the 'Construction (Design and Management) Regulations' (CDM Regulations). We will **not** sign the agreement until you have provided this proof.

(Note: As defined in the CDM Regulations, "client means any person for whom a project is carried out, whether it is carried out by another person or is carried out in-house." The regulations go on to state: "Where the person appointed [as client for the works] makes a declaration [to the HSE that he will act as client for the works for the purposes of these regulations], from the date of the receipt of the declaration by the [HSE], such requirements and prohibitions as are imposed by these Regulations upon a client shall apply to the person so appointed (as long as he remains as such) as if he were the only client in respect of that project." In other words, as client for the works, you will be responsible for meeting the Regulations and making sure that the works are designed and constructed in line with the Regulation. This is not our responsibility.)

Surety

5.43 We must be protected against the risk of unforeseen expenditure if you leave the road works unfinished for any reason. So we will calculate the cost of the road works, including any highway structures, highway drainage and commuted sums (where applicable) and you must provide us with an appropriate surety equal to the cost that we calculate. This may be in the form of:

- a bond with a recognised financial institution; or
- the equivalent sum of monies lodged with us.

5.44 For information on the fees we charge for road works covered by Section 38 agreements and on commuted sums, please see Section ANR9.

Section ANR7: Constructing the road works

Before you begin

5.45 Where works are being carried out under a Section 38 agreement, you must not begin construction unless and until:

- we have given you technical approval;
- the Section 38 agreement has been completed and signed and an appropriate surety is set in place;
- you have provided us with written confirmation that you have notified the Health and Safety Executive that you are client for the works for the purposes of the Construction (Design and Management) Regulations (see paragraph 5.42 for further details);
- all necessary fees have been paid to us; and
- the following requirements have also been satisfactorily completed.

5.46 Notification of start: You must normally give us at least five weeks' notice in writing of your intention to begin construction work or begin it again.

5.47 Approving your contractor: Your road works must be constructed by a contractor (including any subcontractor) who has relevant experience and capabilities and who

The 6Cs Design Guide

must be approved by us or on the Authorities select list if applicable. You must not start construction of the road works until we have approved your contractor.

- 5.48** Where we have had no previous experience of a contractor's work you will be required to provide us with satisfactory references and also examples of similar work which they have successfully completed to the satisfaction of a highway authority. Where you are unable to do this, or where we have previously experienced problems with a contractor (for example with quality of workmanship), we will not approve that contractor.
- 5.49 The contractor's insurance:** You must indemnify us (protect us from legal responsibility) against any claims by third parties arising from the road works. Before we will approve your contractor they must provide us with written evidence that they have, as a minimum, £5 million public liability insurance with no limit on the number of claims.
- 5.50 Pre-start meeting:** You must arrange a 'pre-start' meeting with the appropriate area office to establish and emphasise our stance on a number of issues including:
- approving and issuing drawings;
 - testing procedures;
 - inspecting works;
 - traffic control; and
 - agreed start dates.

Please see our document 'Standard Conditions Applying to Construction' for further details on pre-start meetings.

- 5.51** The meeting should be attended by your representative, the designer, your contractor for the road works, the area office inspector and the development control officer.

Health and safety

- 5.52** You must comply with all aspects of the Construction (Design and Management) Regulations 1994 and indemnify us (protect us from legal responsibility) against all claims, liabilities and actions if you fail to do so. You are also required to submit full details of any traffic management proposals for the construction of the road works for approval by the appropriate area office inspector.

Site inspection

- 5.53** You are responsible for the day-to-day supervision of the road works construction. We will only inspect the works to check that they are being constructed in accordance with the approved drawings and our requirements. You must give our representative access to the works in progress at all times. If problems arise, we will be happy to discuss possible solutions with you, but it will still be your responsibility to instruct your contractor and make sure that the works are satisfactorily completed in accordance with our requirements.
- 5.54** Inspecting construction of the road works included in the Section 38 agreement will normally be carried out by the relevant area office staff. We will give you this information at the 'pre-start' meeting. You must give our representatives access to the works in progress at all times. These visits do not free you from your responsibility for supervising the work and making sure that it is carried out in a proper and safe manner, and in line with the specification.

The 6Cs Design Guide

Timescale for completing the road works

5.55 Once you have begun work on site it is your responsibility to complete the road works to our satisfaction and to make sure the adoption takes place within a 'reasonable' period to minimise any potential risks or inconvenience to residents.

5.56 We impose a time limit on completing road works. Normally, the works must be completed, that is we have issued a provisional certificate, either:

- within one month of all buildings fronting or served by the works being completed; or
- within three years of the date of signing of the Section 38 agreement;

whichever is soonest.

5.57 Where you do not complete the road works within the specified time limit, and we agree an extension of time, we will charge you extra fees towards our additional administrative and inspection costs. Please see paragraph 5.70 for further details. We may call on the bond or use the surety monies that you lodged with us to complete the works.

Section ANR8: Maintaining and adopting the road works

Issuing a provisional certificate

5.58 We will issue a provisional certificate of completion once:

- you have substantially completed the road works to our satisfaction;
- you have completed all street lighting to our satisfaction;
- any new planted landscaping areas, grassed areas, trees, shrubs and so on that we are to adopt have been fully planted and established;
- the works (including any existing and new planted landscaping areas and so on) have been jointly inspected (that is by us, you and your contractor) and no significant defects have been identified, or where they have, you have agreed to remedy them to our satisfaction; and
- where required, any stage 3 safety audit has been completed and all changes that we require have been made satisfactorily.

5.59 When we issue a provisional certificate, the amount of bond excluding the commuted sums element can be reduced, usually to 40% of the original amount. The exception to this is where you are paying us a commuted sum in which case the bond cannot be reduced to a value less than the provisional commuted sums that we have calculated.

5.60 You will then be responsible for maintaining the road works for a minimum period, usually twelve months. This allows any defects in the works to become apparent after they are brought into use.

5.61 Any variations to the areas originally dedicated as public highway in the Section 38 agreement must be included in a supplemental agreement at this time.

The 6Cs Design Guide

Issuing a final certificate

5.62 We will issue a final certificate of completion when the following actions have taken place.

- You must contact us at the end of the maintenance period to arrange a further joint inspection of the road works (including any landscape planting, trees, grassed areas and so on). We will issue you with a list of any outstanding remedial works we require you to do, which you must then complete to our satisfaction.
- You must have maintained the road works to our satisfaction during the maintenance period.
- You must have maintained any existing or new landscape planting, trees, shrubs, grassed areas and so on to our satisfaction during the road works' maintenance period.
- You must provide us with a copy of the provisional certificate of adoption for the drainage and sewers, as issued by the relevant water company.
- You must pay us any commuted sums that are required.
- You must pay us any other charges that are required, for example some Authorities require payment to cover the bulk clean and lamp change for illuminated signs (see Part 4, paragraph 4.114) or to cover similar for street lighting (see Part 4, paragraph 4.128).
- Where the new road is subject to a safety audit, stage 4 must have been completed to our satisfaction. We will decide whether we can issue the final certificate once the stage 4 12-month report has been completed. (Please see appendix D for further information on safety audits).
- You must provide us with 'as built' drawings, preferably in an electronic form on CD, for example Autocad file.
- You must provide us with the health and safety file, on CD, produced in line with the Construction (Design and Management) Regulations 1994 (CDM).

5.63 After all of the above has been done to our satisfaction, we will:

- issue a final certificate of completion;
- inform you that the bond can be cancelled;
- post notices of adoption on-street; and
- adopt all areas dedicated within the Section 38 agreement as highway to be maintained at public expense.

The 6Cs Design Guide

Section ANR9: Payments to us

Our fees

5.64 We make a charge for the work involved in:

- preparing and managing the Section 38 agreement;
- checking the design of the road works, any associated structures and any highway drainage; and
- inspecting the works on site.

5.65 The charge for administration, design checking and site inspection is normally a fixed percentage of the estimated cost of the total road works, as calculated by us, excluding any associated structures (see below) and SUDS and 'non-standard' drainage systems.

5.66 We will make additional charges for design checking and site inspection of highway structures based on 'actual' costs. (Please see Part 4, Section MC15 for further details on structures.) We will also charge additional fees, based on 'actual' costs, for SUDS and 'non-standard' drainage systems. (Please see Part 4, Section MC8 for further details on drainage).

5.67 We will also charge a separate fee of 10% of any commuted sum towards the costs of our additional administration and inspection work.

5.68 There is also an additional fixed fee for each agreement plus disbursements (money we pay on your behalf) to cover legal costs. This fee is fixed by our Legal Department and we review it every year.

5.69 We will also charge an additional fixed fee for any supplemental agreement for extra administration work.

5.70 If the road works are still not complete after the time limit specified in the agreement, we will offer you an extension of up to three-years; however we will re-assess the bond and charge you a further inspection fee based on our assessment of the cost of the outstanding works.

5.71 If a period of two years or more has elapsed since we issued the provisional certificate and the final certificate has not yet been issued, we will charge you a further fixed fee for additional administration and inspection work.

Committed sums

5.72 We normally required committed sums to cover maintenance of such items as highway structures, noise fencing, traffic signals and 'heritage' street lighting where they are to be adopted as part of a publicly maintained highway,. We have now broadened this requirement to give us greater flexibility to adopt 'innovative' layouts and 'non-usual' materials without placing undue burdens either on our budgets or on Council Tax payers.

The 6Cs Design Guide

5.73 So, where in principle we are prepared to adopt them, you will normally also have to pay commuted sums on:

- additional areas exceeding usual highway design standards and which are not required for the safe functioning of the highway;
- materials outside our usual Specification;
- non-usual or additional street furniture;
- landscaping within the proposed highway, including trees; and
- sustainable drainage systems (SUDS), for example, flow-attenuation devices, swales and storage areas).

Note:

Where you are proposing SUDS, you must hold discussions with all relevant parties at an early stage (and certainly before you submit your planning application) to agree ownership and responsibility for the facility.

This is not an exhaustive list. There are other occasions detailed throughout this document where we require the payment of commuted sums, for example vertical traffic calming.

5.74 Part 4, Section MC18 gives more details on commuted sums and how we calculate them.

The 6Cs Design Guide

Application for an agreement under Section 38 Highways Act 1980 Submission check list

The following information is required before the Section 38 can be processed.

Prior to undertaking technical approval checks, the Highway Authority will require a payment to be paid to cover their costs for any checking of the design and preparation of the Section 38 Agreement in the event of the development not taking place. If the Section 38 is entered into then this £1000 will be deducted from the required administration/inspection fees.

The design consultant must be approved by the Highway Authority.

All requested relevant information must be supplied, as this will reduce the time taken to complete the agreement.

It is an offence under each local authority Act of Parliament for work to be carried out for the purpose of constructing a street other than in accordance with plans approved by the Street Works Authority.

Confirmation is required that the submitted layout conforms to all planning requirements.

Please supply one copy of a 1:500 scale plan, drawn on a current survey base, together with calculations and supporting documents showing all relevant details in respect of the following:

The 6Cs Design Guide

Application for an agreement under Section 38 Highways Act 1980 Submission check list

<p>Layout:</p> <ul style="list-style-type: none"> • Plans indicating the areas of proposed highway offered for adoption • Plans indicating the position of all carriageways, footways, footpaths, cycleways, verges, service strips, visibility splays, traffic calming features, surface water drainage including gully positions, position of dwellings, gradients of driveways, garaging and/or parking spaces with vehicular crossings, traffic signs, road markings and structures • For layouts not conforming to normal HA standards, a drawing and schedule indicating different materials proposed together with appropriate areas for use in the calculation of commuted sums • Drawings in 'Autocad' format will be printed by the Authorities and distributed as required • Safety Audit 	Tick
<p>Vertical Alignment:</p> <ul style="list-style-type: none"> • Longitudinal sections of the carriageway showing existing and proposed levels for the centre line, channel, gradients and vertical curves with the appropriate horizontal road layout drawn below this section. • Longitudinal sections must also indicate surface and foul water sewer profiles including the position of manholes, gradients, pipe sizes etc. 	
<p>Standard Details:</p> <ul style="list-style-type: none"> • Typical cross sections showing carriageway, footway and verge construction including details of kerbs and edgings (as per standard drawings) • Typical construction details of footways, footpaths, cycleways, vehicular accesses and pedestrian crossing points kerbs, manholes and pipe bedding (as per standard drawings) 	
<p>Ground Conditions:</p> <ul style="list-style-type: none"> • A geotechnical report, including CBR test results at formation 	
<p>Drainage:</p> <ul style="list-style-type: none"> • Details of existing and proposed surface and foul water drainage, including a highway gully layout • Calculations of surface water run-off, 'micro drainage' etc • A manhole schedule • Details of deeds of easements and discharge consents 	
<p>Landscaping:</p> <ul style="list-style-type: none"> • Details of planting and additional maintenance proposals 	
<p>Other Features:</p> <ul style="list-style-type: none"> • Any specialist information regarding bridges, culverts, headwalls and retaining walls supplied on separate drawings 	
<p>Street Lighting:</p> <ul style="list-style-type: none"> • Some Authorities in the Region will insist on providing a street lighting layout and specification in accordance with BS5489, together with details on any impact on the existing lighting system as part of the Section 38 submission 	

The 6Cs Design Guide

Part 6: Working on existing highways - Section 278 and Section 184 procedures

- [Section WEH1: Introduction](#)
- [Section WEH2: Completing a Section 278 agreement and providing surety](#)
- [Section WEH3: Designing your highway works](#)
- [Section WEH4: Obtaining our approval for your highway works](#)
- [Section WEH5: Constructing the highway works](#)
- [Section WEH6: Maintaining and adopting the highway works](#)
- [Section WEH7: Payments to us](#)
- [Section WEH8: The Land Compensation Act 1973 and the Noise Insulation Regulations 1975](#)

Section WEH1: Introduction

- [General](#)
- [About Section 278 of the Act](#)
- [About Section 184](#)

General

6.1 This part details our requirements for the construction of works on the existing public highway under Section 278 of the [Highways Act](#) . It covers what we will require from you in terms of:

- technical details, including safety audits and drawings, to enable us to approve your proposed highway works;
- completing a Section 278 legal agreement, to provide for the construction of your highway works
- you constructing and maintaining the highway works before we take over their maintenance; and
- our fees and other payments relating to the construction and maintenance of the road.

(Note: Please see our '[Highways Status Search](#)' page for details of which existing roads are adopted)

The 6Cs Design Guide

Figure WEH1 Section 278 procedures

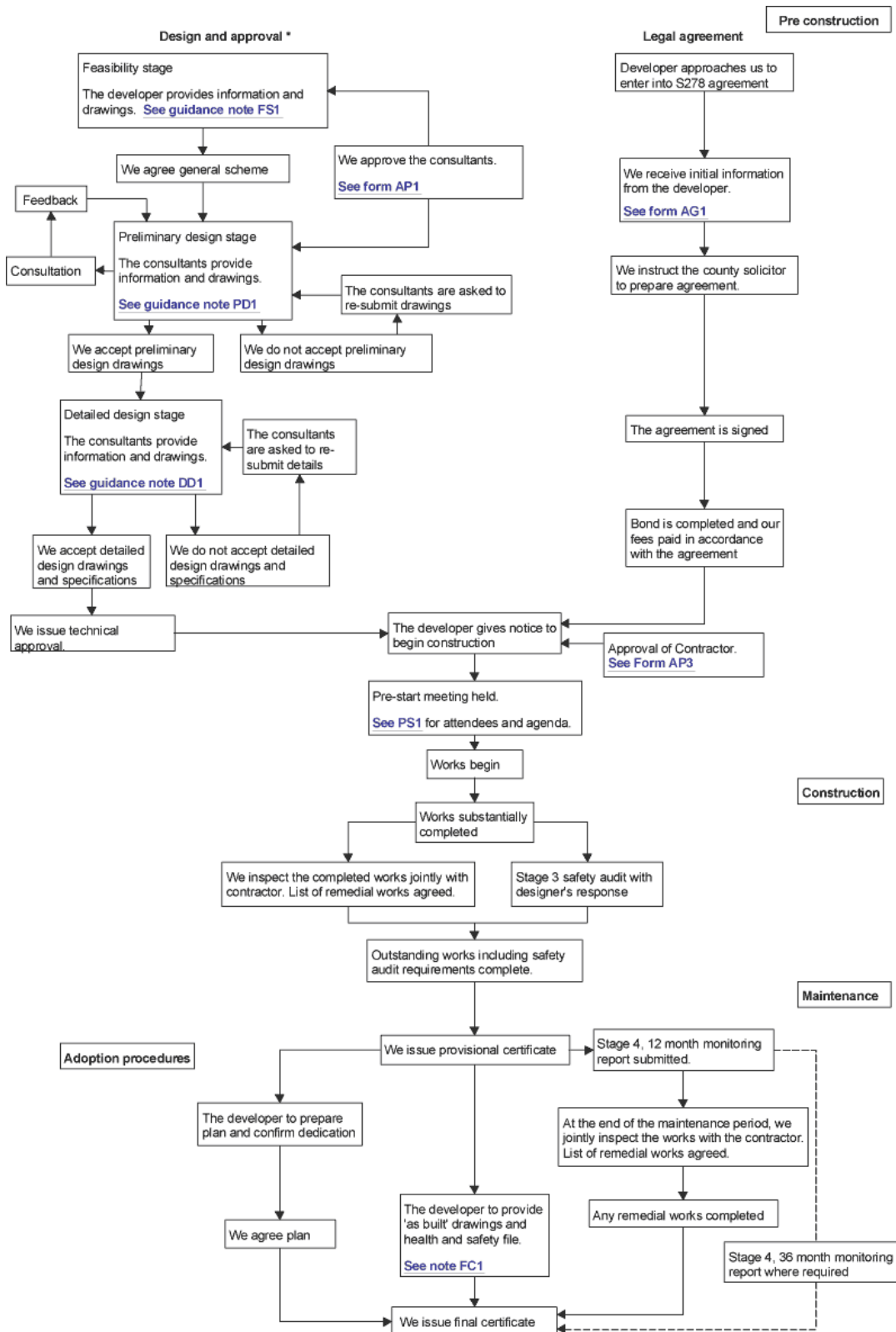

* Note: If you want us to carry out design and approval work before you have completed the Section 278 legal agreement with us, we will normally ask you for an 'abortive costs' letter and/ or up front payment of initial fees. In this letter, you must agree to pay our costs if you do not proceed with your development proposals for any reason. We will not normally carry

The 6Cs Design Guide

out design checking and approval unless we have received this letter or the Section 278 agreement is complete.

6.2 You should consult both us and the planning authority at an early stage of preparing your development proposals, especially if the proposed highway works are extensive and have potentially significant environmental impacts, for example removal of trees and hedges. This will give an opportunity to resolve any potential problems relating to the works before you submit any planning application.

Notes

- Wherever 'the Act' is mentioned in this Part, it refers to the Highways Act 1980 unless otherwise stated.

About Section 278 of the Act

6.3 Where development requires works to be carried out on the existing highway, you will need to complete an agreement with us under Section 278 of the Act.

6.4 Section 278(1) of the Act (as amended by the New Roads and Street Works Act 1991) says: "*A highway authority may, if they are satisfied it will be of benefit to the public, enter into an agreement with any person -*

(a) for the execution by the authority of any works which the authority are or may be authorised to execute, or

(b) for the execution by the authority of such works incorporating particular modifications, additions or features, or at a particular time or in a particular manner,

on terms that that person pays the whole or such part of the cost of the works as may be specified or determined in accordance with the agreement."

6.5 We normally use this section of the Act to allow you, the developer, to employ a contractor and for that contractor to work on the existing public highway in the same way as if we, the highway authority, were carrying out the works instead. You are normally responsible for all aspects of the works on the public highway, from their design, through supervising construction and ensuring that the works are fully and finally completed to our satisfaction.

6.6 Section 278(3) of the Act, says: "*The agreement may also provide for the making to the highway authority of payments in respect of the maintenance of the works to which the agreement relates and may contain such incidental and consequential provisions as appear to the highway authority to be necessary or expedient for the purposes of the works."*

6.7 This section of the Act entitles us to seek expenses for future maintenance and we intend to do this through [commuted sums](#). This will allow us greater flexibility to [adopt](#) non-standard layouts and materials without placing undue burdens on our maintenance budget or Council Tax payers. However, even if you offer a commuted sum payment, we may still not approve your proposals and allow you to work on the highway if we consider them to be inappropriate or unacceptable on highway-safety grounds. (Please refer to [paragraph 6.65](#) onwards for further details on commuted sums.)

The 6Cs Design Guide

6.8 Section 278 agreements are often used together with an agreement under Section 106 of the Town and Country Planning Act 1990. Such agreements, between a planning authority, us (where highway works are covered) and a landowner and developer, are used to regulate developments where using planning conditions would not be appropriate. Granting planning consent depends on the landowner or developer entering into a Section 106 agreement. Section 106 agreements may cover a number of matters such as securing off-site highway works, landscaping, phasing the development, paying sums of money and so on.

6.9 Both Section 278 and Section 106 agreements operate in the same way in relation to highway works. They follow the procedures involved in the approximate order they occur from initial consultations through to final completion of the highway works.

Advice for developers on Section 184 process can be found [here](#).

Section WEH2: Completing a Section 278 agreement and providing surety

- [The Section 278 agreement](#)
- [The Construction \(Design and Management\) Regulations](#)
- [Surety](#)

The Section 278 agreement

6.10 Before you can enter into a Section 278 agreement you must normally obtain full planning permission for the development from the planning authority. This must include approval of any reserved matters relating to the highway works.

Note: If you want to start the Section 278 procedures before you receive planning consent, we will only consider this if you agree to refund all of our costs if planning consent is not given or the development does not proceed for any other reason.

6.11 Each authority has its own standard format for Section 278 agreements. However, at times it will be necessary to make amendments, for example to allow for specific structures and [commuted sums](#).

6.12 You will need to supply certain information before our solicitors can begin preparing the agreement. The information required is listed on [guide AG1](#). This will include, where appropriate, a letter confirming that you will be responsible for all our costs if planning permission is not given or the development does not proceed for any other reason.

6.13 Once we have received the correct information, we will instruct our solicitors to prepare the agreement. You will be charged a fee for us preparing the agreement. Please see [Section WEH7](#).

The Construction (Design and Management) Regulations

6.14 Before we sign the Section 278 agreement, you must provide us with written proof that you have informed the [Health and Safety Executive](#) in writing that you are appointed client for the works for the purposes of the '[Construction \(Design and Management\) Regulations](#)' (CDM Regulations). We will **not** sign the agreement until you have provided this proof.

(Note: As defined in the CDM Regulations, *client means any person for whom a project is carried out, whether it is carried out by another person or is carried out in-house.*" The

The 6Cs Design Guide

regulations go on to state: *Where the person appointed [as client for the works] makes a declaration [to the HSE that he will act as client for the works for the purposes of these regulations], from the date of the receipt of the declaration by the [HSE]), such requirements and prohibitions as are imposed by these Regulations upon a client shall apply to the person so appointed (as long as he remains as such) as if he were the only client in respect of that project.*” In other words, as client for the works, you will be responsible for meeting the Regulations and making sure that the works are designed and constructed in line with the Regulation. This is not our responsibility.

Surety

6.15 We must be protected against the risk of unforeseen expenditure if you leave the highway works unfinished for any reason. So you should provide us with an estimated cost of the highway works for our approval, including any highway structures, highway drainage, works to service providers equipment (for example, gas, water, cable TV). We will provide a cost for any [commuted sums](#) (where applicable). You must provide us with an appropriate surety equal to the approved cost of the highways works including commuted sums. This may be in the form of:

- a bond with a recognised financial institution; or
- the equivalent sum of monies lodged with us.

6.16 For information on the other fees we charge for highway works covered by Section 278 agreements and on commuted sums, please see [Section WEH7](#).



Section WEH3: Designing your highway works

- [General requirements](#)
- [Traffic regulation orders](#)
- [Traffic calming and other traffic management schemes](#)
- [Structures](#)
- [Traffic-signal equipment](#)

General requirements

6.17 The works should normally be designed in line with the standards set out in this document, including [Part 3](#), [Part 4](#) and [our Specification](#). Our [standard conditions](#) applying to highway works for new development provides additional advice, for example on utility equipment (such as gas, water, electricity, and so on). If you have not carried out development in the region before, you should also first read [Part 1](#) and [Part 2](#).

6.18 It is in everyone's interest that the highway works are designed by reputable chartered consulting engineers with experience in designing highway works. So, we must approve the consulting engineers who you choose to design the highway works. At the appropriate time,

The 6Cs Design Guide

you must give us details of the consultants you want to use. You can find a list of the information required on [guide AP1](#).

6.19 We will require safety audits for all highway works covered by Section 278 agreements. They must be carried out by an accredited safety audit team that is independent from the designers. You will be responsible for commissioning and paying for all safety audits. Some authorities in the region will insist on carrying out safety audits in-house. Please see [appendix D](#) for further details on safety audits.

6.20 You must comply with all aspects of the [Construction \(Design and Management\) Regulations 1994](#) and indemnify us (protect us from legal responsibility) against all claims, liabilities and actions if you fail to do so.

6.21 Feasibility stage: You should agree the need for any off-site highway works and their general nature with us before you submit a planning application. We will need to be satisfied that any proposed highway works:

- will off-set the highways and transportation impacts of your development; and
- are possible within the land constraints of the development;

before we recommend to the planning authority that the development is acceptable.

6.22 You will be required to supply key information at the feasibility stage so we can be satisfied that the proposed highway works are possible. You can find a list of the information required in [guide FS1](#).

6.23 The preliminary design stage: When we have agreed the general scheme layout at the feasibility stage, we will need your approved consultants to submit a preliminary design. This should minimise the need for a lot of design changes at the later, [detailed design stage](#). You can find a list of the required documentation we need on [guide PD1](#). Once we have received confirmation that you will be responsible for all the costs if planning permission is not given or your development does not proceed for any other reason, we will check your design.

6.24 At this stage, you or your consultants should talk to other parties who could have an influence on the design of the works, for example [utility providers](#) (for example gas, water, cable TV) or the [Environment Agency](#). You should then analyse any comments you receive and forward them to us (together with your response) for a decision.

6.25 In the case of traffic-calming schemes, we will carry out consultations with interested parties in accordance with [paragraph 6.31](#). After we have received and analysed comments, we will forward our decision to you. You must incorporate any changes to the design we ask for as a result of the consultations.

6.26 The detailed design stage: When we have approved the preliminary design, we will need your consultants to submit the detailed design. You can find a full list of the requirements on [guide DD1](#).

6.27 At this stage we will:

- serve the appropriate notices to the utility companies under the New Roads and Streetworks Act; · carry out noise assessments if appropriate; and
- design the street lighting.

The 6Cs Design Guide

6.28 When we have accepted the detailed design, we will issue conditional approval.

6.29 The agreement will state that we must approve the detailed design before any construction work starts.

Traffic regulation orders

6.30 Where a development requires changes to an existing traffic regulation order (TRO) or a new order is required, you will normally be required to pay all costs associated with this, including all consultation and legal costs. TROs are subject to statutory [procedures and consultations](#). This can be a very lengthy process and a successful outcome is not guaranteed. You should get advice on the likely timescale and take this into account when you programme your proposals.

Traffic calming and other traffic management schemes

6.31 Where the works involve traffic calming, we will consult with interested parties, such as the parish or town council and the local county councillor and residents, about the traffic-calming schemes in line with normal Council practice. This may include a public exhibition and other consultations beyond minimum statutory requirements. We also carry out consultations on other traffic management schemes, in line with our normal policies and procedures (which we will advise you of during the design process).

6.32 After we have received and analysed comments, we will forward our decision to you. You must incorporate any changes to the design we ask for as a result of the consultations.

6.33 You must pay the costs of this consultation whether or not the outcome is successful. You should remember that the consultation procedure can be lengthy which will have implications on the programme of works.

Structures

6.34 Where the highway works involve structures please refer to [Part 4, Section MC15](#) for design requirements.

Traffic-signal equipment

6.35 Regional practices vary for the design of road layouts that require traffic-signal equipment. You are advised to contact the respective Council directly at an early stage to establish local practices.

6.36 Regional practices vary for the design, supply and installation of permanent traffic-control equipment which forms part of the highway works. You are advised to contact the appropriate Council directly at an early stage to establish local practices.

6.37 You must normally pay us a [commuted sum](#) towards the future maintenance of the traffic-signal equipment. Please also see [Part 4, Section MC18](#) for further details on our commuted sums policy.

6.38 You must allow us access at all reasonable times to any part of the site on which cables, pipes, ducts or other apparatus associated with the traffic-signal equipment is to be installed or is located. This will enable us to carry out any works we need to do to install and maintain the cables, pipes ducts or other apparatus.

The 6Cs Design Guide

Section WEH4: Obtaining our approval for your highway works

6.39 We will only issue a technical approval when:

- we have completed all design checks;
- the [stage 1 and 2 safety audit](#) processes have been satisfactorily completed; and
- you have supplied any amended details we require.



Section WEH5: Constructing the highway works

- [Before you begin](#)
- [Health and safety](#)
- [Site inspection](#)
- [Timescale for completing the highway works](#)

Before you begin

6.40 Where works are being carried out under a Section 278 agreement, you must not begin construction unless and until:

- we have given you [technical approval](#);
- the [Section 278 agreement](#) has been completed and signed and an appropriate surety is set in place;
- you have provided us with written confirmation that you have notified the [Health and Safety Executive](#) that you are client for the works for the purposes of the [Construction \(Design and Management\) Regulations](#) (see paragraph 6.14 for further details);
- all necessary [fees have been paid](#) to us; and
- the following requirements have also been satisfactorily completed

6.41 Notification of start: You must normally give us at least five weeks' notice in writing of your intention to begin construction work or begin it again.

6.42 Approving your contractor: Your highway works must be constructed by a contractor (including any sub-contractor) who has relevant experience and capabilities. You must not start construction of the highway works until we have approved your contractor. So, you must supply information about the contractor you want to use. You can find a list of the information we need on [guide AP3](#).

6.43 Where you are unable to supply us with satisfactory details, or where we have previously experienced problems with a contractor (for example with quality of workmanship) we will not approve that contractor.

6.44 The contractor's insurance: You must indemnify us (protect us from legal responsibility) against any claims by third parties arising from the highway works. Before we

The 6Cs Design Guide

will approve your contractor they must provide us with written evidence that they have, as a minimum, £5 million public liability insurance with no limit on the number of claims.

6.45 Pre-start meeting: You must arrange a 'pre-start' meeting with the appropriate [area office](#) and inform residents and the local member. You can find a list of people who should be present at the meeting, and a typical agenda, in [PS1](#).

Health and safety

6.46 You must comply with all aspects of the [Construction \(Design and Management\) Regulations 1994](#) and indemnify us (protect us from legal responsibility) against all claims, liabilities and actions if you fail to do so. You are also required to submit full details of any traffic management proposals for the construction of the highway works for approval by the appropriate officer.

Site inspection

6.47 You are responsible for the day-to-day supervision of the highway works construction. We will only inspect the works to check that they are being constructed in accordance with the approved drawings and our requirements.

6.48 It is in everyone's interests that the works are supervised by a competent engineer who is experienced in site supervision of highway works. So we must approve the supervising engineer. The level of supervision you must provide will depend on the nature and scale of the works. For larger schemes, you must provide supervision at all times. We will discuss and agree the level of supervision you must provide at the pre-start meeting.

6.49 You must give our representatives access to the works in progress at all times. These visits do not free you from your responsibility for supervising the work and making sure that it is carried out in a proper and safe manner, and in line with the specification. The agreement will state that you must carry out the highway works to our satisfaction and you must comply with any reasonable requests made by our representatives.

Timescale for completing the highway works

6.50 Once you have begun work on site it is your responsibility to complete the highway works to our satisfaction and within a 'reasonable' period to minimise any potential disruption to highway users.

6.51 We impose a time limit on completing highway works. Normally, the works must be completed, that is we have issued a [provisional certificate](#), not later than 12 months after their construction started but this may be a substantially shorter period on minor schemes.

6.52 Where you do not complete the highway works within the specified time limit and we agree an extension of time, the Authorities reserve the right to charge you extra fees towards our additional administrative and inspection costs. Please see [paragraph 6.63](#) onwards for further details. We may call on the bond or use the surety monies that you lodged with us to complete the works.

The 6Cs Design Guide



Section WEH6: Maintaining and adopting the highway works

- [Issuing a provisional certificate](#)
- [Issuing a final certificate](#)

Issuing a provisional certificate

6.53 We will issue a [provisional certificate of completion](#) once:

- you have substantially completed the highway works to our satisfaction;
- you have completed all street lighting to our satisfaction and provided appropriate electrical test certificates;
- any planted landscaping areas, grassed areas, trees, shrubs and so on that we are to [adopt](#) have been fully planted and established;
- the works (including any existing and new planted landscaping and so on) have been jointly inspected (that is by us, you and your contractor) and no significant defects have been identified, or where they have, you have agreed to remedy them to our satisfaction;
- the [stage 3 safety audit](#) has been completed and all changes that we require have been made satisfactorily; and
- you have supplied us with a plan showing any areas of land that are to be dedicated as highway and you must provide any highway boundary markers.

6.54 When we issue a provisional certificate the amount of bond can be reduced, usually to 40% of the original amount. The exception to this is where you are paying us a [commuted sum](#) in which case the bond cannot be reduced to a value less than the 'provisional' commuted sums that we have calculated.

6.55 You will then be responsible for maintaining the highway works for a minimum period, usually twelve months. Some Authorities in the region will require an extended maintenance period for soft landscaping. This allows any defects in the works to become apparent after they are brought into use.

Issuing a final certificate

6.56 We will issue a [final certificate of completion](#) when the following actions have taken place.

- You must contact us at the end of the maintenance period to arrange a further joint inspection of the highway works (including any landscape planting, trees, grassed areas and so on). We will issue you with a list of any outstanding remedial works we require you to do, which you must then complete to our satisfaction.
- You must have maintained the highway works to our satisfaction during the maintenance period.

The 6Cs Design Guide

- You must have maintained any existing or new landscape planting, trees, shrubs, grasses areas and so on to our satisfaction during the highway works' maintenance period.
- You must pay us any [commuted sums](#) that are [required](#).
- You must pay us any other charges that are required, for example some authorities make a charge to cover the bulk clean and lamp change for illuminated signs (see [Part 4, paragraph 4.114](#)) or to cover similar for street lighting (see [Part 4, paragraph 4.129](#)).
- Stage 4 safety audit must have been completed to our satisfaction. We will decide whether to issue the final certificate once the Stage 4 12-month report has been completed. (Please see [appendix D](#) for further information on safety audits).
- You must provide us with 'as built' drawings, preferably in an electronic form on CD, for example Autocad file. See [guide FC1](#).
- You must provide us with the health and safety file, on CD, produced in line with the Construction (Design and Management) Regulations 2007 (CDM).
- The land dedication plan must be agreed.
- Paid all staff costs.

6.57 After all of the above has been done to our satisfaction, we will:

- issue a final certificate of completion;
- inform you that the bond can be cancelled; and
- [adopt](#) any areas dedicated to us as highway to be maintained at public expense.

Section WEH7: Payments to us

- [Our fees](#)
- [Commuted sums](#)

Our fees

6.58 We make a charge for the work involved in:

- preparing and managing the Section 278 agreement;
- checking the design of the highway works, any associated structures and any highway drainage; and
- inspecting the works on site.

6.59 The charge for administration, design checking and site inspection varies across the region but is normally a fixed percentage based on the estimated cost of the total highway works, as agreed with the authority or actual cost of total highway works, as agreed with the local authority at an early stage to discuss fees.

6.60 We will make additional charges for design checking and site inspection of highway structures based on 'actual' costs. (Please see [Part 4, Section MC15](#) for further details on structures.) We will also charge additional fees, based on 'actual' costs, for [SUDS](#) and ['non-standard' drainage systems](#). (Please see [Part 4, Section MC8](#) for further details on drainage.)

6.61 We will also charge a separate fee of 10% of any [commuted sums](#) towards the costs of our additional administration and inspection work.

The 6Cs Design Guide

6.62 There is also an additional fixed fee for each agreement plus disbursements (money we pay on your behalf) to cover legal costs. This fee is fixed by the Legal Department and we review it every year.

6.63 If the highway works are still not complete after the time limit specified in the agreement, we will offer you an extension of up to twelve-months; however we will reassess the bond and charge you a further 3% inspection fee based on our assessment of the cost of the outstanding works, with a minimum charge of £1000.

6.64 If a period of two years or more has elapsed since we issued the provisional certificate and the final certificate has not yet been issued, we will charge you a further fixed fee of £500 for additional administration and inspection work.

Commuted sums

6.65 For some time we have normally required commuted sums to cover maintenance of such items as highway structures, noise fencing, traffic signals and 'heritage' street lighting where they are to be adopted as part of works carried out under a Section 278 Agreement, We have now broadened this requirement in accordance with the Adept guidance document "Commuted Sums For Maintaining Infrastructure Assets" to ensure works required to enable new development do not place undue burdens either on our budgets or on Council Tax payers.

6.66 So you will normally have to pay commuted sums on all works carried out as part of a Section 278 agreement, including:

- all materials (whether or not they are materials outside our usual Specifications);
- any street furniture;
- any signing and lining
- any new landscaping within the highway, including trees; and
- Sustainable Drainage Systems (SuDS), for example, flow-attenuation devices, swales and storage areas).

Note: Where you are proposing SuDS, you must hold discussions with all relevant parties at an early stage (and certainly before you submit your planning application) to agree ownership and responsibility for the facility.

This is not an exhaustive list. There are other occasions detailed throughout this document where we require the payment of commuted sums, for example vertical traffic calming.

6.67 Part 4, Section MC18 gives more details on commuted sums and how we calculate them.

6.67 [Part 4, Section MC18](#) gives more details on commuted sums and how we calculate them.

Section WEH8: The Land Compensation Act 1973 and the Noise Insulation Regulations 1975

6.68 Under the Land Compensation Act 1973 people can claim compensation if the value of their property is depreciated by noise and other specified physical factors arising from the use of a new or altered highway. The Noise Insulation Regulations 1975 require us to offer noise insulation or grants to occupiers of dwellings subjected to noise at or above the

The 6Cs Design Guide

specified level due to the use of a new or altered highway. The agreement contains a clause requiring you to indemnify us (protect us from legal responsibility) against the full costs of any payments we make under these regulations. We will notify you about any claim we receive and also about any offers of noise insulation we are making, if any.



Appendices

- [Appendix A:](#) Useful contact details - how to contact us, district councils and so on
- [Appendix C:](#) Assessing the transport impacts of development proposals (includes some information on travel plans) - explains how you should normally prepare an assessment, including guidance on preparing a scoping report and criteria for assessing traffic impacts.
- [Appendix D:](#) Additional information on safety audits - what are they and when should they be carried out
- [Appendix E:](#) Additional information on private area requirements - reasons behind the various requirements
- [Appendix F:](#) Preservation of trees - guidance on identifying trees to be preserved and on how you should protect them during construction
- [Appendix G:](#) Landscaping on new developments - advice on species and planting
- [Appendix H:](#) Air quality management areas - details of the various areas
- [Appendix I:](#) Our other procedures - details on other matters that may need to be taken into account in preparing development proposals, for example traffic regulation orders.
- [Appendix J:](#) Advance payments code (APC) - gives background information on the APC and how it is applied in Leicestershire.
- [Appendix K:](#) Tell us what you think - please complete the form included in this appendix if you have any comments on the 6Cs design guide. Any suggested changes will be considered through our review process, which is also included.
- [Appendix L:](#) Our definition of a Street - describes the attributes of a road which



we consider make it fit within the category of a "Street" as described in Manual for Streets 1 and 2

- [Appendix M](#): The Department for Communities and Local Government (DCLG) research paper on residential car parking
- [Appendix N](#): 6CsDG Business Plan
- [Appendix O](#): Pre application Checklist
- [Appendix P](#): S184 Advice & Forms



The 6Cs Design Guide

Part 8 - Glossary

%ile design speed: This is the speed which a certain percentage of drivers do not exceed. So if the 85%ile design speed of a road is 20mph, 85% of vehicles will travel at 20mph or less.

1 in 30 year return period design storm: A storm of an intensity (in terms of volume and duration of rainfall) that statistically can be anticipated to occur once every 30 years. This does not mean, however, that storms of this intensity will only occur once every 30 years. Such storms can occur more or less frequently.

Adopted road, adoption, to adopt and so on: A road built by a developer will be a '[private road](#)' maintained by the [frontagers](#) unless we take it over to be maintained at public expense. When we take over of the road, we 'adopt' it and the road is then referred to as being 'adopted'.

Advance payments code (APC): A provision of the [Highways Act](#) 1980. The advance payments code provides for us to secure money from you to cover the cost of works in private streets next to new buildings, for example to cover the costs of building the roads in a new development. Before any work begins on the development, you must deposit a sum of money with us to make sure that we can complete the roads within the development to a suitable standard if you fail to complete them. You have one month to appeal against the amount set out in an official notice and you are liable to a fine if you start work on the development before you have paid or secured the money. [See Part 5, Section ANR2 for more information.](#)

Air quality management areas (AQMA): These are areas identified by local authorities where legal national air quality standards are not being met or are not expected to be met by the end of 2005. There are several of these areas in the Counties of Leicestershire, and these are shown in [appendix H](#).

B1, B2 and B8 developments: Developments are given different classifications. B1 is the classification for a business which can be carried out in a residential area, for example, some types of offices and research work, without affecting the area by noise, vibration, smell, fumes, smoke, soot, ash, dust or grit. Other classifications include B2 (general industrial) and B8 (storage and distribution).

Base traffic: This can include:

- existing traffic plus any adjustments for land use which is removed from the site because of the proposed development;

The 6Cs Design Guide

- general traffic growth; and
 - any traffic which results from committed development (for example development included in a [development plan](#) or has planning permission).
-

Bend radius: This is the measurement of a bend in a road measured along its centre line. The smaller the radius, the tighter the bend.

Better Places to Live: A companion to [PPG3](#) this is a guide to better practice in the design of residential developments. It aims to promote greater attention to the principle of good design in order to raise the quality of housing layout and design.

Better Streets, Better Places: Research report resulting from the Office of Deputy Prime Minister's project on [PPG3](#) and Highway [Adoption](#) Procedures. The report sets out the findings of the project, describing the key problems that have been identified and setting out recommendations for action.

Binder course: This is part of the road-surface construction. Formerly known as the 'base course', it is the second layer of construction, immediately below the running surface (known as '[surface course](#)').

Block surfacing: This consists of concrete or clay blocks laid in a pattern on a bed of sand, and which in appropriate circumstances can be used as alternative to a 'tarmac' surfacing.

Bond: A bond is a form of financial guarantee which will cover our costs if you do not complete the development for any reason and we need to take over and complete the works instead.

Boxed culvert: This is a square or rectangular cross-section structure which runs under a road and carries a watercourse, for example a stream.

Brownfield site: This is land that has previously been used or developed and is not currently fully in use, although it may be partly used. Or it may be vacant, derelict or contaminated.

Building Plans: Under the Building Regulations – which exist to ensure the health and safety of people in and around all types of buildings (that is domestic, commercial and industrial) – anyone who is proposing to erect or extend a building must submit a plan(s) of

The 6Cs Design Guide

their proposals to the relevant local authority (usually a district or city council) for approval. The passing of these plans is the trigger for the [Advance Payments Code procedure](#).

Bunding: In this document this refers to an earth mound, sometimes planted, that forms either a visual or noise screen (or both). For example, bunding may be used to screen a new road from adjacent houses.

Commission for Architecture and Built Environment (CABE): A public body, funded by the government, CABE state they believe that well designed homes, streets, parks, work-places, schools and hospitals are the fundamental right of everyone. It further states that it will use its skills and resources to work for higher quality of life for people and communities across England.

Capping (layer): If the ground is structurally weak or likely to be subjected to exceptional loads, a capping layer might be required. This is simply selected fill material, often crushed rock, laid in layers and thoroughly compacted up to the [sub-base layer](#).

Catch pits: These are maintenance access chambers on a drainage system which include a sump to collect materials that might otherwise block a drain, ditch or watercourse.

CBR: This refers to the California Bearing Ratio – a test to measure the strength (softness or hardness) of the [subgrade](#) of a road.

CCTV: Closed circuit television.

Centre-line radius: This is the radius of an imaginary circle which has a bend in the road as part of its circumference. The centre-line radius has to be increased on bends to accommodate larger vehicles, for example buses or lorries.

Commuted sum: Provided for under the [Highways Act](#) 1980, this is a sum of money paid to us by a developer to cover the future maintenance costs of certain areas or items that we are going to [adopt](#) and maintain at public expense. Please see [Part 4, Section MC18](#) for further details.

Concept proposal: This is an outline of a proposal to be submitted for planning permission. Its purpose is to bring together all highways and transportation, planning and

The 6Cs Design Guide

any other relevant matters to demonstrate how you propose to deliver a safe and accessible high-quality development that can be satisfactorily maintained.

It should normally consist of one or more plans along with any supporting information. It should fit together clearly, consistently and logically with any transport assessment and draft travel plan. When you are preparing it, you should refer to the relevant design guidance set out in this document and also take account of 'designing out crime' issues.

The specific content of the concept proposal will depend on:

- whether your development proposals are explicitly covered by this design guidance; and
- whether you are intending to submit an outline or detailed planning application for your development.

Please see [Part 2, Section PDP4](#) for further details.

Construction (design and management) regulations 2007: These regulations state what must be done and what cannot be done when designing and managing construction works. (The Regulations define construction work as any building, civil engineering or engineering construction work.) The CDM regulations define the roles and responsibilities of everyone involved with construction work, including those who commission the works, those who design them and those who construct them. The [Health and Safety Executive](#) enforces the regulations (and all other health and safety laws in Great Britain). Anyone breaking the law could face criminal prosecution.

[For full citation and link to online version.](#)

Crossfall: This is the camber - the slope from one side of the road to the other.

Development plan: This document is prepared by a planning authority and sets out policies on land use and development, including highways and transport, over a particular period. Examples include structure plans (prepared by county councils) and local plans (prepared by district councils). Structure plans and local plans are to be replaced by local development documents as a result of recent changes in planning legislation.

DfT: The Department for Transport.

Easement: This refers to the right (secured by a legal agreement) to use or cross someone else's land for a specified purpose, for example to carry out work on underground pipes.

Emergency accesses: These are closed to general motor vehicles and are for use by the emergency services only, for example the police and fire brigade,. Gates or removable

The 6Cs Design Guide

bollards are usually placed at each end. They are not encouraged, as development layouts should be designed to allow easy access for emergency vehicles, so that emergency access should be necessary only in exceptional circumstances.

Entry ramp: An upward sloping ramp used at road junctions. Located at the start of the side road, the ramp controls the speed of a vehicle that has turned from the main road into the side road.

Figure GL1 Example of an entry ramp



Exempted developments: Under Section 219 (4) of the [Highways Act](#) certain buildings shall be exempt for various reasons from payments under the [Advanced Payment Code](#). The Act details the exemptions.

Final certificate: We issue this certificate either under a Section 38 or [Section 278](#) agreement once you have completed and maintained (usually for at least 12 months) road or highway works to our satisfaction. Once we have issued the certificate, we become responsible for maintaining the works at public expense and the [bond](#) can be cancelled. See also [provisional certificate](#).

Footpath: This is a pedestrian route that is open to the public (a public right of way), often running across open fields but sometimes providing links within urban areas.

Footway: This is a pedestrian route that runs alongside a carriageway as part of a road.

The 6Cs Design Guide

Formation level: This is the level of the ground the various layers of a road's construction are founded on.

Frontager: This refers to someone whose residence or business fronts onto a road. The frontager can be a private householder in a residential area for example, or a company.

Further and higher education: Further education is education up to 'A' level standard, or equivalent, for people over compulsory school age (16 in England). Courses may be taught in a sixth-form college, a further-education college or, in some cases, a higher-education institute. Higher-education courses are normally above 'A' level standard (degrees for example) and the courses are normally taught in universities and higher-education colleges.

GENERATE: This is a computerised database which holds traffic data on different development types. See also [TRICS](#).

Gravity model: A gravity model is a simple computer model used to estimate journeys (trips) between a fixed starting point, for example a proposed new housing development, and particular destinations.

Headwall: A headwall is a retaining wall at the end of a culvert or drain that supports the banks of rivers or streams and ensures that they are not eroded by discharged water.

Highways Act 1980: In broad terms this Act governs the construction, maintenance, operation, use and control of the public highway.

Health and Safety Commission (HSC): Appointed by the Government, the HSC's main concern is the health, safety and welfare of people at work, and the public. Its activities include proposing new laws and standards, conducting research and providing information and advice. The HSC is helped to carry out its functions by the [Health and Safety Executive](#).

Health and Safety Executive (HSE): A public body, funded by the Government, the HSE's job is to help the [Health and Safety Commission](#) to make sure that risks to people's health and safety from work activities are properly controlled. It is also responsible for enforcing health and safety law in Great Britain and has powers to prosecute if the law is broken.

The 6Cs Design Guide

Home zone: A home zone is a street or group of streets where people and vehicles share the road space safely and equally and where quality of life takes precedence over making traffic movement easy.

Invert: This is the lower inner surface of a drain.

Jointing chamber: This is a chamber (covered hole) in the ground which allows easy access to cables if they need repairing.

Latitudinal gradient: This is the camber - the slope from one side of the road to the other.

Local transport plan (LTP): LTPs set out a local authority's priorities over a five-year period. (current document runs from 2006 to 2011). It includes transport strategies, aims and objectives.

Each year, authorities produce 'Annual progress reports' (APR) as part of the LTP process. APRs set out how money has been spent on highway and transport improvements and how this has contributed to achieving LTP aims and objectives.

The Government gives money to local authorities for improving highways and transport based on the LTP process.

Longitudinal gradient: This measures the amount a road rises and falls along its length.

Manhole: A covered chamber without a sump which gives access to underground pipes and equipment, for example, drains and telephone cables.

Minor traffic assessment (MinTA): This assesses the impact of a relatively small development on the existing highways and transport network. It should normally be a very simple document (perhaps just one page). Please see [Part 7, appendix C](#) for further information on transport assessments.

Major transport assessment (MajTA): More comprehensive than a minor transport assessment, this assesses the impact of a larger development on the existing transport network over a wide area. It should also assess provision for walking, cycling and public transport and also look at the car-parking demand and provision. A draft [travel plan](#) should normally form part of a MajTA.

The 6Cs Design Guide

Modal split: This is a breakdown of types of transport used to travel to and from a development, for example the percentage of people who walk, cycle, use a bus or travel by car.

NGUJ7: The National Joint Utilities Group (NJUG) is an organisation that looks after the interests of utility providers (for example, gas, water, cable TV). NJUG7 is a document produced by this organisation which recommends where utility equipment should be positioned.

Non-standard drainage systems: For the purposes of this document, this covers any system which includes features other than normal pipes, manholes, catchpits, culverts or headwalls. This will generally include [SUDS](#) and pollution control devices which result in higher maintenance costs.

Paving the Way: Published following a study commissioned by the 'Commission for Architecture and Built Environment', this report focusses on the process of decision making that has produced the kinds of streets we see in towns and cities. It seeks to understand how and why streets are created and cared for, and in doing so to identify what the impediments are to the creation of good streetscapes.

Perched water table: A perched water table can occur where the ground contains isolated layers of less permeable soil (such as clays). If water collects above these isolated layers, perched water tables may develop which can affect pore water pressure (the pressure exerted by the water within the pores or voids in a porous material). See also [water table](#).

Figure GL2 Perched water table

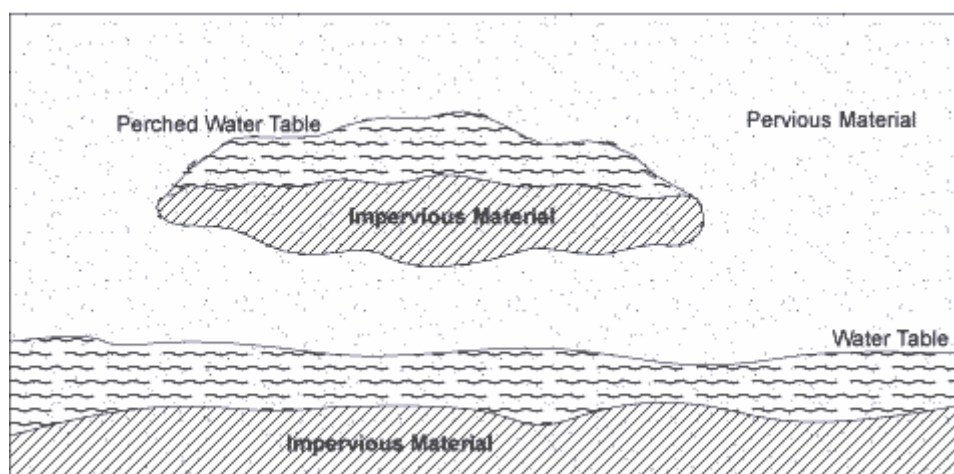

Personal injury accidents (PIAs): These are road accidents which result in a person either being taken to hospital for treatment or being killed. PIAs are recorded by both the police and us,. Central government has set targets to reduce PIAs. (Accidents where no

The 6Cs Design Guide

one requires hospital treatment and no one is killed are generally referred to as 'damage only'.)

PPS3 'Housing': This is a planning policy statement published by the Department for Communities and Local Government. It gives guidance, among other things, about the provision and location of housing land and type and affordability of housing. It also promotes good design in new housing developments to create attractive, high-quality living environments which people will want to live in.

PPG13 'Transport': This is planning policy guidance published by the Office of the Deputy Prime Minister. It gives guidance which promotes:

- more sustainable transport choices for both people and for moving freight;
 - accessibility to jobs, shopping, leisure facilities and services by public transport, walking and cycling; and
 - less need to travel, especially by car.
-

Priority junction: This describes a 'T' junction, cross roads or any other junction layout that has 'Give Way' (or Stop) markings and traffic is not controlled by any other means (for example by traffic signals or roundabout).

Private road (or street or access or area): This is a road (or so on) that is not opted and is maintained by the [frontagers](#) rather than by us. It may or may not be a road to which the public has a right to unrestricted access.

Provisional certificate: We issue this certificate either under a Section 38 or [Section 278](#) agreement once road or highway works have been completed to our satisfaction. Issuing the certificate marks the beginning of a period (usually a minimum of 12 months) where you are responsible for maintaining the works. The bond can also be reduced, normally to 10% of its original value. See also [final certificate](#).

Residential access road: This is a road with separate provision and surfaces for vehicles and pedestrians, that is it has a carriageway and separate footways.

Residential access way: This is an area with one common surface for all users, that is there is no separate carriageway or footways.

The 6Cs Design Guide

RPG8: This is the abbreviation for the current Regional Planning Guidance for the East Midlands issued by the Secretary of State in January 2002. It provides a framework to use when deciding the best form and location of a development to meet the economic, environmental and social needs of the region. Local planning authorities must take it into account when they prepare their [development plans](#).

Sags and crests: These are dips and peaks in the road.

Scoping report: This is a report prepared before a major transport assessment to identify its requirements. Its purpose is to establish key factors that will influence later stages of work. This should avoid the possibility of you carrying out work which later has to be stopped because it was based on incorrect assumptions.

Section 38: Section 38 of the [Highways Act](#) 1980 provides for a highway authority to [adopt](#) by agreement a road built by a third party. A road adopted under Section 38 will be maintained at public expense.

Amongst other things, Section 38 entitles us to seek expenses for maintenance and we intend to do this through [commuted sums](#) .

Please see [Part 5](#) for details on our Section 38 procedures.

Section 104: Section 104 of the Water Industries Act 1991 provides for a 'sewerage undertaker' (water company) to take over, by agreement, ownership and maintenance of any 'sewer or sewer disposal works'.

Section 106: Section 106 of the Town and Country Planning Act 1990 provides for agreements to control the development or use of land. A local planning authority (district council) may enter into a Section 106 agreement with a landowner which, for example, prevents a certain activity being carried out on a site, or which prevents the development proceeding until a particular time. Section 106 agreements can also be used to secure financial contributions from the developer, for example to fund improvements to the highway or public transport or to fund education facilities. We are often a party to Section 106 agreements too.

Section 219: Section 219 of the [Highways Act 1980](#) forms part of the [advance payment code](#). It is the part of the code that provides for us to secure payment from you to cover the costs of constructing the roads within a new development. We would use the money to complete the roads if you failed to do so.

The 6Cs Design Guide

Section 220: Section 220 of the Highways Act 1980 is another part of the advance payment code and sets out the timetable for serving notices on developers for the payment of the money. We must serve the notice within six weeks of the development receiving building regulations approval.

Section 278: Section 278 of the Highways Act provides for works funded by developers to be carried out on the existing public highway with our agreement. For example, this might include constructing a new roundabout to provide access to a development or improving an existing junction to accommodate extra traffic generated by the development.

Amongst other things, Section 278 entitles us to seek expenses for maintenance and we intend to do this through [commuted sums](#).

Please see [Part 6](#) for details on our Section 278 procedures.

Shuttle-working: This is where the road has only one lane and traffic in one direction has to wait for traffic travelling in the opposite direction to pass before it can proceed. It is often used at road works where it is controlled by temporary traffic signals. But shuttle working can also be used to help control vehicle speeds as part of a traffic-calming scheme, as shown in the example below.

Figure GL3 Example of a shuttle-working speed control feature



Speed order: This regulation allows a local authority to set a speed limit in a [Home Zone](#). The regulation is not yet in place, but draft regulations have been published by the Government for consultation purposes.

The 6Cs Design Guide

Sub-base: This is the bottom layer of a road's construction. Made up of crushed, well-compacted stone, it is formed either directly on the subgrade or, where ground conditions are poor, on a [capping layer](#).

Subgrade: This is the layer of naturally-occurring material the road is built on, or it can refer to material that has been used to create an embankment to build the pavement on.

SUDS: This is the acronym for sustainable urban drainage systems. In general terms, it is an approach to managing rainfall that imitates natural drainage. Water run-off (from house roofs or yards, roads and so on) is collected and stored to allow natural cleaning to occur before it drains into the surrounding earth or it is released into watercourses (streams, rivers and so on).

Surface course: Formerly known as the 'wearing' course, this is the uppermost surface of a road which vehicles run on.

Sustrans: Sustrans describes itself as a transport charity that works on practical projects to reduce motor traffic and its adverse effects by encouraging people to walk, cycle and use public transport.

Swept path: This is the width needed to accommodate the movement of vehicles as they manoeuvre. Larger vehicles, such as HGVs and 15m-long rigid buses, have a large swept path in comparison with the space that a car requires to manoeuvre. The swept path varies as vehicles move from a straight section of highway to a curved section.

Technical approval: You must submit to us design details for all road or highway works that are to be carried out either under a Section 38 or [Section 278](#) agreement. Once we are satisfied with the design, we give it technical approval. You must not start the works until we have issued this approval.

TEMPRO: TEMPRO is the acronym for the Department for Transport's **Trip End Model Presentation Program**. It is based on development information provided by local authorities and is used to analyse data about trip ends (destinations), journey mileage, car ownership and the population and workforce. TEMPRO is also often used to estimate how much traffic might grow by over a particular time and area.

Topography: This refers to the natural land features of a region.

The 6Cs Design Guide

Tracking: Tracking is providing the required width for vehicle movement within the overall width of the road. It can also be used to establish an appropriate [bend radius](#). Instead of taking the highway engineering requirements as the starting point for layout design, you can consider the arrangement of the buildings and the boundaries of the development first. You can lay out buildings to suit a particular form, with kerblines helping to define and emphasise spaces. The width between kerbs can vary. (You can find further information on how to use tracking in '[Places, Streets and Movement](#)', published by the Department for Transport).

Figure GL4 Example of tracking. Reproduced with kind permission of Jelson Ltd and Boreham Consulting Engineers.



Travel plan: This refers to a package of measures tailored to the needs of individual sites and aimed at reducing reliance on the car, for example by encouraging more use of public transport, walking and cycling. It involves developing a set of mechanisms, initiatives and targets (as appropriate) that together can enable an organisation to reduce the impact of travel and transport on the environment. It is a process that will grow and develop with time and reflect the changing circumstances of an organisation and its environment.

TRICS: This computerised database holds traffic survey data, such as the amount of traffic a surveyed development generates, as well as information about its size and other descriptions relevant to the development and its location. See also [GENERATE](#).

Turning head: This is the space at the closed end of a cul-de-sac (or similar) which allows vehicles to turn round without having to reverse over long distances or cause damage to verges or footways.

The 6Cs Design Guide

Unilateral undertaking: Under the terms of a contract or an agreement, one party can act without the permission or approval of the other parties.

Unitary authority: A unitary authority is an administrative division of an area and is in place of a two-tier system (that is, there is no separate county or district councils). A unitary authority is responsible for all local government functions in the area.

Use class: Under the planning system, development types are grouped together into use classes. For example, shops are grouped together in use class A1; restaurants, bars and takeaways in A3; storage and distribution warehousing in B8.

Use order: This regulation allows a local authority to designate how roads in a [Home Zone](#) are to be used. The regulation is not yet in place, but the Government has published draft regulations for consultation.

Visibility splays: These are the sight lines, for example at junctions and on bends, required to make roads safe for motoring - it must be possible to see and be seen.

Water table: This is the level below which the soil is permanently saturated. See also [perched water table](#).
