

# The 6Cs Design Guide

## Part 3 Design guidance

- [Section DG1: Introduction](#)
- [Section DG2: Road layouts](#)
- [Section DG3: Home Zones](#)
- [Section DG4: Mixed-use developments](#)
- [Section DG5: Speed control](#)
- [Section DG6: Public transport](#)
- [Section DG7: Pedestrians and cyclists](#)
- [Section DG8: Horse riders](#)
- [Section DG9: Lining, signing and traffic regulation orders](#)
- [Section DG10: Street lighting](#)
- [Section DG11: Utility equipment \(for example, gas, water, cable TV\)](#)
- [Section DG12: Drainage](#)
- [Section DG13: Landscaping](#)
- [Section DG14: Vehicle parking and making provision for service vehicles](#)
- [Section DG15: Parking for motor cycles](#)
- [Section DG16: Parking for cycles](#)
- [Section DG17: Considering parking provision together with transport assessments and travel plans](#)
- [Section DG18: Residential developments served by private drives and areas](#)
- [Section DG19: Employment and commercial developments served by private drives and areas](#)
- [Section DG20: Marking the highway boundary](#)



### Section DG1: Introduction

3.1 The guidance contained in this part is intended to help you design development layouts that provide for the safe and free movement of all road users, including cars, lorries, pedestrians, cyclists and public transport. You should select and assemble appropriate design elements to:

- provide road layouts which meet the needs of all users and restrain vehicle dominance;

# The 6Cs Design Guide

- create an environment that is safe for all road users and in which people are encouraged to walk, cycle and use public transport and feel safe doing so; and
- help create quality developments in which to live, work and play.

We believe that such an approach, coupled with the flexibility that our guidance allows, already reflects many key themes of the [Manual for Streets 2 \(MfS2\)](#). Also, we have revised certain aspects of 6CsDG to reflect specific MfS2 guidance, particularly with regard to visibility splays. We recognise, however, that further work is required to bring 6CsDG even more closely in to line with the MfS2, in particular with regard to our road design descriptions and guidance. Meanwhile, this will not stop us seeking residential development layouts that recognise that roads have a wider role to play in creating a sense of place and community as opposed to simply having a functional transport role.

3.2 Where this cannot be achieved by development layouts that are explicitly covered by this guidance, we are prepared to be flexible. Subject to [Part 1 paragraph 1.16](#) onwards we will consider layouts that are not covered by the guidance.

3.3 Where development proposals do not align with either the principles or guidance set out in this document it is likely that we will seek to resist those proposals in the interest of the users of the highway network and its primary role in providing safe and effective transport for all. However, if the proposals are significantly out of line with the principles and guidance the Council may recommend a refusal.

## Section DG2: Road layouts



- [General geometry and safety audit requirements](#)
- [Emergency accesses](#)
- [The design of residential road layout widths based on tracking](#)
- [Vertical curves](#)
- [Visibility splays](#)
- [Junction design within a development](#)
- [Junction spacing within a development](#)
- [Private-access restrictions](#)
- [Widening on bends](#)
- [Turning heads](#)
- [Materials and construction](#)
- [Adopting new roads](#)

3.4 This section sets out our design guidance for [adoptable roads](#). You can find guidance on Home Zones, public transport, providing for pedestrians and cyclists, and providing for horse riders in sections [DG3](#), [DG6](#), [DG7](#) and [DG8](#), respectively.

*(Note: Please see our ['Highways Status Search'](#) page for details of which existing roads are adopted)*

# The 6Cs Design Guide

3.5 We will continue to encourage developers to create layouts that are to an adoptable standard and that will be offered for adoption. We will not normally adopt developments of five or less dwellings.

3.6 For employment and commercial developments, we will normally expect road layouts serving developments of more than one building and with more than one occupier to meet our adoptable design guidance and be offered for adoption. However, you are encouraged to contact the relevant highway authority with to discuss their adoption requirements for specific proposals. (See [Section DG19](#) for employment and commercial developments served by private drives and areas.)

3.7 You can find advice on how to get your roads adopted under Section 38 of the Highways Act in [Part 5](#) of this document.

## General geometry and safety audit requirements

Note: Please see [appendix D](#) for additional information on safety audits.

3.8 External roads and other off-site highway works: These are roads that provide a new link in the road network and serve a more general purpose than simply giving access to a development. Unless they fall outside the definition of a road (street) as set out in [appendix L](#), you should normally design these in line with the appropriate parts of the Manual for Streets 1 and 2 and our [Specification](#) and [standard drawings](#). They should contain measures to control vehicle speeds and to limit the impact on the environment. We will require safety audits in all cases. We may be prepared to consider permitting direct frontage access from properties to such roads providing that they are subject to a 40mph speed limit and 85th percentile speeds are 40mph or less.

3.9 Site access to external roads: Unless the external road falls outside the definition of a road (street) as set out in [appendix L](#), you should normally design these in line with the appropriate parts of the Manual for Streets 1 and 2, and our [Specification](#) and [standard drawings](#). We will not normally accept mini-roundabouts unless they form part of a more comprehensive traffic-calming scheme that is either required to minimise the development's impacts or that has previously been identified. A mini-roundabout will not be acceptable where it is proposed simply because the necessary visibility for a [priority junction](#) cannot be achieved. We may be prepared to consider permitting direct frontage access from properties to the external road providing that they are subject to a 40mph speed limit and 85th percentile speeds are 40mph or less.

3.10 Site-specific requirements will depend on a number of factors including:

- location;
- safety considerations;
- traffic, pedestrian and cycle flows; and
- public transport requirements.

You should establish and agree our requirements with us in the early stages of preparing your development proposals. We will require safety audits in all cases.

3.11 Internal development roads: These are roads that serve only the development. You should normally design them in line with the sections below, which cover residential developments around 1000 dwellings and employment and commercial developments, and

# The 6Cs Design Guide

our [Specification](#) and [standard drawings](#). We will consider the design of development roads for sites of over around 1000 dwellings, or which are otherwise not covered by the following guidance, on a site-by-site basis.

3.12 We will not normally require safety audits of internal development roads unless:

- the layout contains features which are not explicitly covered by this document; or
- the proposal is for or contains a Home Zone.

**Figure DG1 Examples of shared surfaces**



3.13 Table DG1 gives general geometry for internal residential roads. In general terms, a residential access road is a conventional cross-section road with separate provision for vehicles and pedestrians. On a residential access way users share a common surface.

# The 6Cs Design Guide

**Table DG1: General geometry of residential roads (internal)**

	Major Residential access road	Residential access road	Residential access way
Type of use	Mainly vehicles (bus access likely)	Mainly vehicles	Mainly pedestrians and cyclists. Not normally acceptable for use on a bus route
Normal dwelling limits	1000 Normally no more than 400 from a single point of access <sup>(a)</sup>	400 Normally no more than 150 from a single point of access <sup>(a)</sup>	50 Normally no more than 25 from a single point of access <sup>(a)</sup>
Access to schools <sup>(b)</sup>	Yes	Yes, but not as a cul-de-sac	No
85th %ile design speed	20mph	20 mph	15mph
Shared surface	No	No	Yes <sup>(c)</sup>
Widths for two-way traffic:  Note: Where a road is to be narrowed, to help control vehicle speeds, for example, the minimum <i>carriageway</i> width (kerb to kerb) = 3.7m. Minimum <i>lane</i> width at a restriction, such as pedestrian refuge in the middle of the road = 3.2m.	Carriageway width; <sup>(d) (f)</sup>  6.75m	Carriageway width: <sup>(d) (f)</sup> 4.8m up to 50 dwellings 5.5m 50 to 400 dwellings  Except on a bus route where the carriageway should be a minimum of 6m wide (subject to <a href="#">tracking assessment</a> ) or on a road serving a school where the carriageway should be 6.75m wide in all cases.	Overall corridor width; <sup>(e) (f)</sup>  7.5m
Centre-line radius	Defined by tracking <sup>(g)</sup>	Defined by tracking <sup>(g)</sup>	Defined by tracking <sup>(g)</sup>
Crossfall	1:40	1:40	1:40
Longitudinal gradient	Flexible surfacing minimum: 1:100 Block surfacing minimum: 1:80 In all	Flexible surfacing minimum: 1:100 Block surfacing minimum: 1:80 In all cases maximum:	Flexible surfacing minimum: 1:100 Block surfacing minimum: 1:80 In all cases

## The 6Cs Design Guide

	cases: 1:20 <sup>(h)</sup> In all cases at junctions: not to exceed 1:30 for first 10m of the side road	1:20 <sup>(h)</sup> In all cases, at junctions: not to exceed 1:30 for first 10m of the side road	maximum: 1:20 <sup>(h)</sup> In all cases, at junctions: not to exceed 1:30 for first 10m of the road
Vertical curves. See <a href="#">paragraph 3.25</a>	See paragraph 3.25	See <a href="#">paragraph 3.25</a>	See <a href="#">paragraph 3.25</a>
Visibility distance at junctions, bends and vertical crests	25m	25m <sup>(i)</sup>	17m <sup>(i)</sup>
Verges		Grassed verges minimum 1m wide, minimum area 10sqm. Hard paving otherwise	Grassed verges minimum 1m wide, minimum area 10sqm. Hard paving otherwise
Steps		Not normally acceptable in areas to be adopted as public highway unless a suitable alternative ramp is provided for those unable to climb steps.	Not normally acceptable in areas to be adopted as public highway unless a suitable alternative ramp is provided for those unable to climb steps.

(a) We will consider developments in excess of the single-access limits on a site-by-site basis. See also [paragraph 3.15](#).

(b) Care must be taken in the design of roads serving schools. Parking in the vicinity of schools as children are dropped-off or collected, is a serious safety hazard and can cause traffic congestion.

For new residential developments, any need for a new school on the site must be established early on (see [Part 2 para 2.10](#) onward). The school should be located to maximise opportunities:

- for children to walk and cycle to school;
- to provide safe routes to school; and
- to minimise the risk of on-street parking problems.

All of this will need to be considered as part of the transport assessment for the development and a school travel plan will be required.

## The 6Cs Design Guide

Where a proposed development requires the expansion of an existing school, (that is the construction of one or more new classrooms) the traffic impacts of the expansion must be considered early on and as part of any transport assessment required for the development. Measures will normally be required to provide 'safe routes to school' and minimise the risk of causing or making worse on-street parking problems.

(c) The [Manual for Streets](#) suggests that shared surfaces work well in short lengths or where they form cul-de-sacs, where traffic is less than 100 vehicles per hour, and where parking is controlled. Care must be taken in the design of shared-surface layouts to ensure that the development's whole design, including building type and layout, use of street furniture and so on, conveys to users the nature of the area. Motor vehicles should not dominate and the layout should not simply appear to be a road without footways. Vertical traffic calming measures are not acceptable on shared surfaces.

It is also important that any shared surface is designed for blind or partially sighted people and that they include an alternative means for visually impaired people to navigate by. As the [Manual for Streets](#) documents emphasises, we will expect you to consult with relevant representative groups and access officers in designing your proposals.

The type of surfacing materials will normally be a secondary feature in defining the nature of the area. It will not normally be acceptable simply to use a different material to convey the nature of an area to users. We will consider the surfacing material you propose for any shared-surface area with regard to the development's overall design, including proposed housing layouts.

(d) The carriageway width does not include any footways, verges and so on. We may be prepared to accept a narrower, single *carriageway* width of 3.7m between kerbs over short lengths as a speed-control feature. The minimum *lane* width of 3.2m applies only where there are limited restrictions, for example where a pedestrian refuge is provided in the middle of the road.

(e) The corridor width is the minimum space required to accommodate all likely road users and utility equipment (for example, gas, water, cable TV). It does not include any additional space for outward-opening windows, drainage downpipes and so on where dwellings front direct onto the highway. You should define vehicle paths within the corridor by a tracking assessment. See [paragraph 3.21](#).

(f) Where a proposed building fronts directly on to the highway, that is, it has no front garden, it should be set back at least 0.5m behind the proposed highway boundary to allow for opening of windows, drainage downpipes, overhanging eaves and so on .

(g) See [paragraph 3.21](#).

(h) Taking into account the needs of people with impaired mobility, we may be prepared to consider a relaxation to on sites with particularly difficult topography. However, relaxations should not form the starting point of longitudinal design. The financial cost of cut/fill is not a material consideration when assessing the ability to achieve gradients to aid walking/cycling.

(i) See also paragraphs [3.26](#) and [3.27](#).

3.14 Table DG2 gives the general geometry for internal employment and commercial roads. In general terms, both major industrial access roads and the minor industrial roads are

## The 6Cs Design Guide

conventional cross-section roads with separated provision for vehicles and pedestrians, but their designs vary depending on likely levels of heavy-goods vehicles (HGVs).

**Table DG2: General geometry of employment and commercial roads <sup>(a)</sup>**

	Type of internal development road	Type of internal development road
	Major industrial access road	Minor industrial access road
Planning use class	B2 to B8 <sup>(c)</sup>	B1 <sup>(b) (c)</sup>
Development limit	Normally no more than 8 hectares for a single point of access <sup>(d)</sup>	Normally no more than 8 hectares for a single point of access <sup>(d)</sup>
85th %ile design speed	30mph	25mph
Shared surface	No	No
Widths for two-way traffic	Carriageway width: 7.3m	Carriageway width: 6m for offices 6.75m for other B1 uses
Centre-line radius	55m minimum	Defined by tracking <sup>(e)</sup>
Crossfall	1:40	1:40
Longitudinal gradient	Minimum: 1:100 Maximum: 1:20 <sup>(f)</sup> At junctions: not to exceed 1:30 for first 10m of the side road	Minimum: 1:100 Maximum: 1:20 <sup>(f)</sup> At junctions: not to exceed 1:30 for first 10m of the side road
Vertical curves	See <a href="#">paragraph 3.25</a>	See <a href="#">paragraph 3.25</a>
Visibility distance at junctions, bends and vertical crests	70m <sup>(g)</sup>	45m <sup>(g)</sup>
Verges	Grassed verges minimum 1m wide, minimum area 10sqm. Hard paving otherwise.	Grassed verges minimum 1m wide, minimum area 10sqm. Hard paving otherwise.
Steps	Not normally acceptable in areas to be adopted as public highway unless a suitable alternative ramp is provided for those unable to climb steps.	Not normally acceptable in areas to be adopted as public highway unless a suitable alternative ramp is provided for those unable to climb steps.

(a) Other [use classes](#), for example shopping and leisure, will be considered on a site-by-site basis and depending on the likely numbers of HGVs.

(b) We will recommend planning conditions to restrict change of use from B1 to B2 - B8 developments unless the roads provided are to major industrial road standard – including construction specification – or the development layout provides for their future improvement at a developer's expense.

(c) Where a B1 development is large enough to generate significant numbers of HGVs, we may require a major industrial road. However, where a B2 - B8 development is small



# The 6Cs Design Guide

enough to generate only a small number of HGVs, for example business starter units, we may be prepared to accept a minor industrial access road instead.

(d) We will consider developments in excess of the single access limits on a site-by-site basis. See also [paragraph 3.15](#).

(e) See [paragraph 3.21](#).

(f) Taking into account the needs of people with impaired mobility, we may be prepared to consider a relaxation to 1:12 on sites with particularly difficult topography.

(g) See also paragraphs [3.26](#) and [3.27](#).



## Well- connected street and Emergency accesses

3.15 New residential streets should be designed to form part of a well-connected street network. Well-connected street networks have significant advantages:

- A shorter route can be used to cover a given area;
- reversing may be avoided altogether;
- they also minimise land-take by avoiding the need for wasteful turning areas at the ends of cul-de-sacs;
- encourage more people to walk and cycle to local destinations, improving their health while reducing motor traffic, energy use and pollution;
- more people on the streets leads to improved personal security and road safety- research shows that the presence of pedestrians on streets causes drivers to travel more slowly;
- for utility companies - service provision and alternative service routes;
- for highway and utility maintenance operations as traffic can be routed around a point closure if it is necessary to excavate the carriageway for maintenance.

3.16 As such developments will usually need at least two access points to the highway network. The number of external connections that a development provides depends on the nature of its surroundings. These access points should be to [adoptable](#) standards and available for general public use.



## The 6Cs Design Guide

3.17 However, cul-de-sacs may provide the best solution for developing awkward sites where the site is linear in nature, has difficult topography, boundary or other constraints and where through routes are not practical.

3.18 We will not normally accept emergency accesses because of:

- enforcement problems arising from their misuse;
- difficulties encountered by the emergency services;
- maintenance issues and vandalism of access-control equipment; and
- general crime and anti-social behaviour problems

3.19 However, where there are valid reasons why this cannot be achieved, and where the development proposal is otherwise acceptable to us, we may be prepared to consider an emergency access as long as:

- highway safety is not compromised and the access is not likely be a source of crime or anti-social behaviour problems;
- there are appropriate means of controlling its use;
- you have fully consulted the emergency services and the proposals are acceptable to them (your consultations with the police should include both traffic management and the Police Architectural Liaison Officer);
- the access is designed to accommodate safely all vehicles likely to use it; and
- long-term maintenance responsibilities are clearly defined and secured.

3.20 Where suitable access arrangements cannot be achieved, we may refuse to adopt the development roads.

### **The design of residential road layout widths based on tracking**

3.21 Tracking is providing the required width for vehicle movement within the overall width of the road. It can also be used to establish appropriate bend radii. Instead of taking the highway engineering requirements as the starting point for layout design, you can consider the arrangement of the buildings and the boundaries of the development first. You can lay out buildings to suit a particular form, with kerb lines helping to define and emphasise spaces. The width between kerbs can vary. (You can find further information on how to use tracking in the [‘Manual for Streets’](#) documents, published by the Department for Transport [\(an example\)](#). Where tracking of large vehicles results in the use of the whole width of the carriageway to make manoeuvres on narrow roads it is important to ensure that forward visibility to bends is provided in accordance with Part 3 Table DG4 to enable this to be achieved safely. There should be no recourse to reducing the width of roads such that it is necessary for the drivers of the private motor car to make use of the whole width of the carriageway to make similar manoeuvres”

3.22 You will then need to check the layout, including widths and bend radii, to make sure that the various types of vehicles you expect to visit and use the road layout can manoeuvre. This is normally likely to include a refuse lorry, fire tender and pantechnicon (for example, a removal lorry) and a bus if the development will be served by public transport. You should do this using a computer software package to generate swept paths for particular types of vehicles and to superimpose them onto layout drawings.

# The 6Cs Design Guide

3.23 The tracking assessments will need to take account of any planned or likely on-street parking (see Section DG14, in particular [paragraph 3.188](#) onwards).

3.24 You should check the proposed layout and get our agreement before submitting a planning application. The layout will also need to satisfy other relevant design guidance for the road type to achieve the design speed and to create a safe environment for all road users, including pedestrians and cyclists.

## Vertical curves

3.25 Where changes in gradient occur, vertical curves will be required at sags and crests. Except where indicated in the notes to Table DG3, curve lengths should normally be either:

- the sum  $K \times A$ , where  $K$  is given in Table DG3 and  $A$  is the algebraic difference of the gradients expressed as a percentage; or
- the 'minimum length for appearance' given in Table DG3;

whichever is higher.

### Example calculation of length of vertical curve

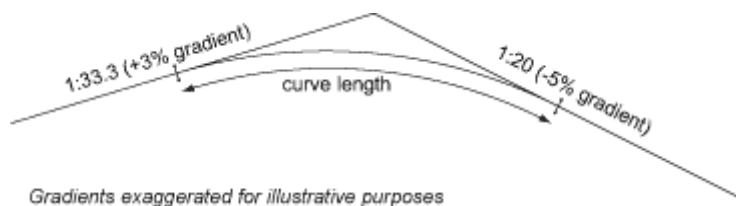

For 20mph design speed  $k = 3$  (from Table DG3)

Algebraic difference of gradients expressed as a percentage =  $+3.0 - (-5.0)$   
= 8.0

Curve length =  $3 \times 8$   
= 24

(minimum length for appearance = 20m (from table DG3))

# The 6Cs Design Guide

**Table DG3: Vertical curves for all internal roads** <sup>(a) (b)</sup>

85th %ile design speed (mph)	Minimum length of vertical curve <sup>(c)</sup>	Minimum length of vertical curve <sup>(c)</sup>
	K	Minimum length for appearance (metres) <sup>(d)</sup>
30 <sup>(e)</sup>	6.5	30
25 <sup>(e)</sup>	4	25
20	3	20
15	2	20

(a) You should hold early discussions with us for large, flat sites to ensure that the vertical alignment is acceptable. In some cases, it may be necessary to provide combined kerb and drainage units to ensure both an acceptable alignment and drainage of the highway.

(b) For crests, it may be necessary to increase the length of vertical curve derived in order to achieve the visibility distance as set out in table DG4.

(c) We may accept shorter curve lengths where there are exceptional difficulties in achieving the length normally required

(d) To avoid stretches of road where water gathers, do not apply the minimum length where A is less than five on any sag curve that results in a low point on the road.

(e) Speeds on new residential development roads should normally be restricted to 20mph or less.

## Visibility splays

3.26 Table DG4 sets out visibility splays normally required for junctions, bends and at vertical crests. The starting point when calculating visibility splays should be the Manual for Streets, unless the external road falls outside the definition of a street as set out in Appendix L. Otherwise you should use the calculation in the Design Manual for Road and Bridges. For proposed internal development roads, you should normally base visibility splay on an assessment of likely 85th% ile vehicle speeds. For existing roads, you should base it on measured vehicle speeds. We will normally require you to carry out radar surveys to measure existing speeds and establish the 85th% ile.

3.27 While taking into account the design speeds in Tables DG1 and DG2, we will assess visibility requirements based on likely vehicle speeds within a proposed development. Where we are satisfied that speeds are, in practice, likely to be lower than the design speeds, we will normally be prepared to consider correspondingly shorter splays. The

## The 6Cs Design Guide

reverse is also true - if speeds are likely to be higher, the splays will need to be correspondingly greater in length.

**Table DG4: Visibility splays**

Assessed likely vehicle 85th %ile vehicle speed (mph)	Measured 85th %ile vehicle speed (mph)	Visibility distance at junctions, bends and vertical crests (m) <sup>(a)</sup>	
		Light vehicles	HGV and buses <sup>(e)</sup>
15	11 to 15	17 <sup>(c)</sup>	19 <sup>(c)</sup>
20	16 to 20	25 <sup>(c)</sup>	27 <sup>(c)</sup>
Speeds on new residential development roads should normally be controlled to 20mph or less <sup>(b)</sup>	21 to 25	33 <sup>(c)</sup>	36 <sup>(c)</sup>
Speeds on new residential development roads should normally be controlled to 20mph or less <sup>(b)</sup>	26 to 30	43 <sup>(c)</sup>	47 <sup>(c)</sup>
Speeds on new residential development roads should normally be controlled to 20mph or less <sup>(b)</sup>	31 to 35	54 <sup>(c)</sup>	59 <sup>(c)</sup>
Speeds on new residential development roads should normally be controlled to 20mph or less <sup>(b)</sup>	36 to 40	65 <sup>(d)</sup>	73 <sup>(c)</sup>
Speeds on new residential development roads should normally be controlled to 20mph or less <sup>(b)</sup>	41 to 44	120 <sup>(d)</sup>	120 <sup>(d)</sup>
Speeds on new residential development roads should normally be controlled to 20mph or less <sup>(b)</sup>	45 to 53	160 <sup>(d)</sup>	160 <sup>(d)</sup>
Speeds on new residential development roads should normally be controlled to 20mph or less <sup>(b)</sup>	54 to 62	215 <sup>(d)</sup>	215 <sup>(d)</sup>
Speeds on new residential development roads should normally be controlled to 20mph or less <sup>(b)</sup>	63 to 75	295 <sup>(d)</sup>	295 <sup>(d)</sup>

(a) See Figure DG2 below for guidance on constructing splays.

# The 6Cs Design Guide

- (b) Where speed is assessed to be over 20mph, splay provision will normally be based on the appropriate 'measured 85th %ile vehicle speed' distance.
- (c) Based on the [Manual for Streets](#), documents 'adjusted for bonnet length' distances.
- (d) Based on [Design Manual for Roads and Bridges](#).
- (e) Use figures for HGV and buses if these vehicles make up more than 5% of actual or predicted total traffic flow.
- (f) We will accept calculated values for actual agreed 85th percentile speeds

[up to top](#) | [back to contents page](#)

## Figure DG2 Construction of visibility splays

(For all horizontal visibility splays, where a footway, cycle way or similar is provided, the rear of the footway and so on should coincide with (match) the rear edge of the visibility splay.)

A more accurate assessment of a visibility splay is made by measuring to the nearside edge of the vehicle track. The measurement is taken from the point where this line intersects the centerline of the minor arm unless there is a splitter island in the minor arm.

## Figure DG2a Junctions

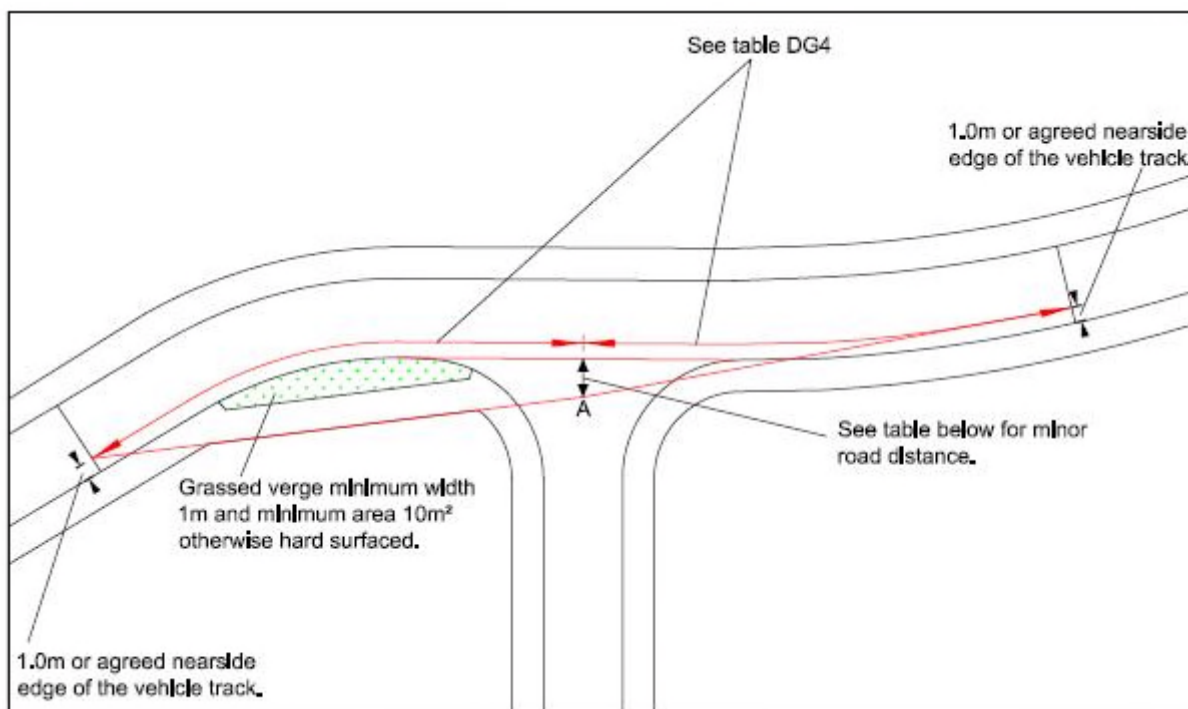

## The 6Cs Design Guide

Main road  Side road	Road (street) as defined at Appendix L	Residential access road	Residential access way	Major industrial access road	Minor industrial access road
Residential access road	2.4m	2.4m	2.4m		
Residential access way	2.4m	2.4m	2.4m		
Major industrial road	4.5m			4.5m	4.5m
Minor industrial road	4.5m - 2.4m*			4.5m - 2.4m*	4.5m - 2.4m*

\* Set back will depend on scale and nature of proposed development

### **Figure DG2b Bends**

Note: For all road types **within** a development, visibility (at junctions, bends or crests) in the vertical plane should normally be measured from a drivers eye-height of no less than 1.05m above the road surface to a point no less than 0.6m above the road surface. This is as set out in the [Manual for Streets](#) documents. On roads **outside** of the development, for example at the site access, the visibility should normally be measured from an eye-height of not less than 1.05m to a point not less than 0.26m, in line with the [Design Manual for Roads and Bridges](#). However, if they fall within the definition of a road (street) as defined at [appendix L](#), visibility can normally be measured as if the road lies **within** a development

# The 6Cs Design Guide

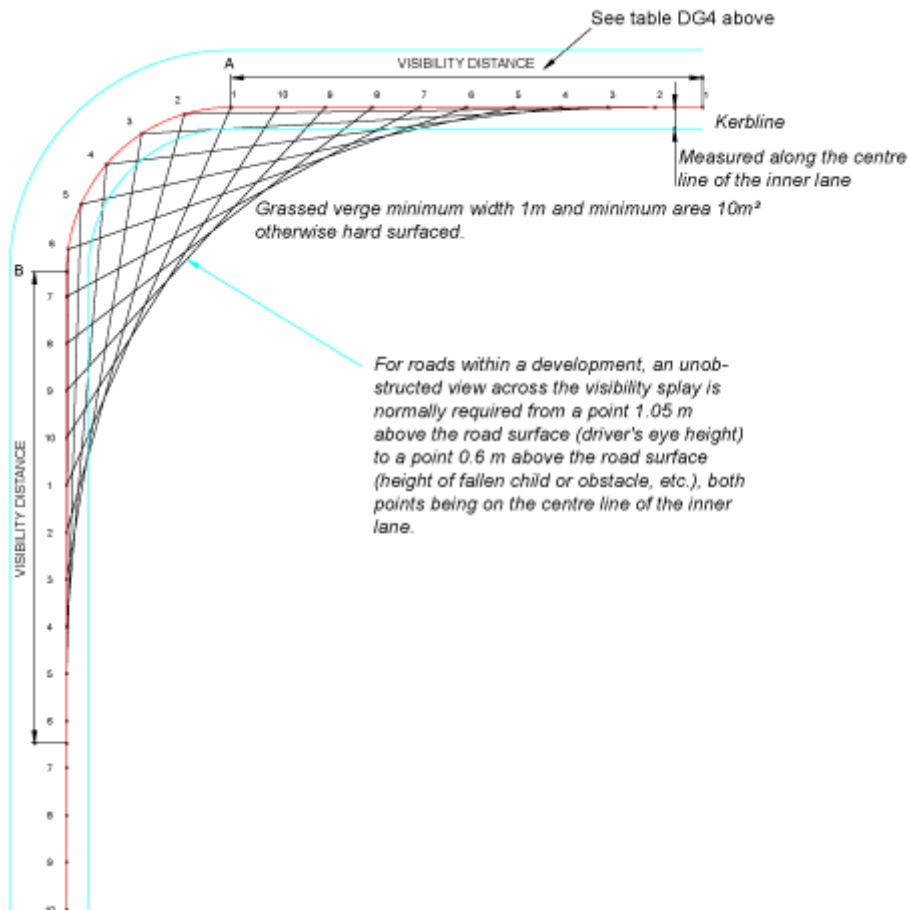

**Figure DG2c Crests in road (brow of hill)**

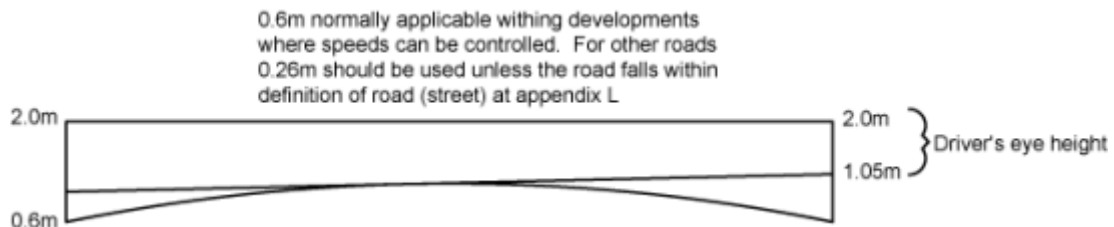

## Junction design within a development

3.28 Basic junction forms should be determined at the [concept layout \(masterplanning\) stage](#) with the more detailed proposals developed as the development proposal evolves.

Table DG5 and the accompanying illustrations highlight broad junction types and the corner radii that should normally be provided within developments.



# The 6Cs Design Guide

**Table DG5: Broad junction types and corner radii within developments <sup>(a)</sup> <sup>(b)</sup>**

Nodal form	T	Y	Cross / Staggered	Multi armed	Square	Circus	Crescent
Regular							
Irregular							

The above diagram is based upon Figure 7.9 of the Manual for Streets documents. The Manual for Streets is copyright of the Department for Transport and Department of Communities and Local Government.

Development type <sup>(d)</sup>	Road type <sup>(e)</sup>	Corner radii (m) <sup>(f)</sup> <sup>(g)</sup> <sup>(h)</sup>
Residential	Entry to a Residential access way or road or junction between access ways and roads	6m <sup>(b)</sup>
Industrial and commercial		
Use class B1 offices	Entry to Minor industrial access road or junction between access roads	6m
Other B1 uses	Entry to Minor industrial access road or junction between access roads	10m
Use classes B2 to B8	Entry to Major industrial access road or between access roads	

## The 6Cs Design Guide

- (a) See [paragraph 3.9](#) for site access junctions.
- (b) A lower radii may be acceptable if suitable tracking is carried out
- (c) See [Section DG9](#) for details on lining and signing.
- (d) Development types not listed will be considered on a site-by-site basis.
- (e) For further details, please [paragraph 3.11](#) onwards.
- (f) Radii based on road widths set out in [Table DG1](#) and [Table DG2](#), assuming that roads meet at an angle of 90 degrees. For other circumstances (including any proposals for tighter radii), you will be required to provide computer tracking assessments ([see paragraph 3.21](#)) of your proposed layout.
- (g) Other factors will also be taken into account in considering your junction proposals. This includes the likelihood of on-street parking problems in the vicinity of the junction and whether or not the roads are likely to form part of a bus route.
- (h) Where a corner radius is less than 7.5m, footway strengthening will be needed. Please see [Part 4 paragraph 4.97](#).

### **Junction spacing within a development**

3.29 You should normally avoid priority-controlled ('Give way') crossroads. When a crossroads cannot be avoided, you should normally provide an appropriate form of control such as a roundabout. Mini-roundabouts will not normally be acceptable to provide access to a development unless they form part of a more comprehensive traffic-calming scheme that is either required to reduce the development's impacts or that has previously been identified.)

3.30 You should space road junctions on the same side of a road so that a vehicle waiting to enter the main road at one does not interfere with visibility for a vehicle waiting at another.

# The 6Cs Design Guide

**Figure DG3 Junction spacing**

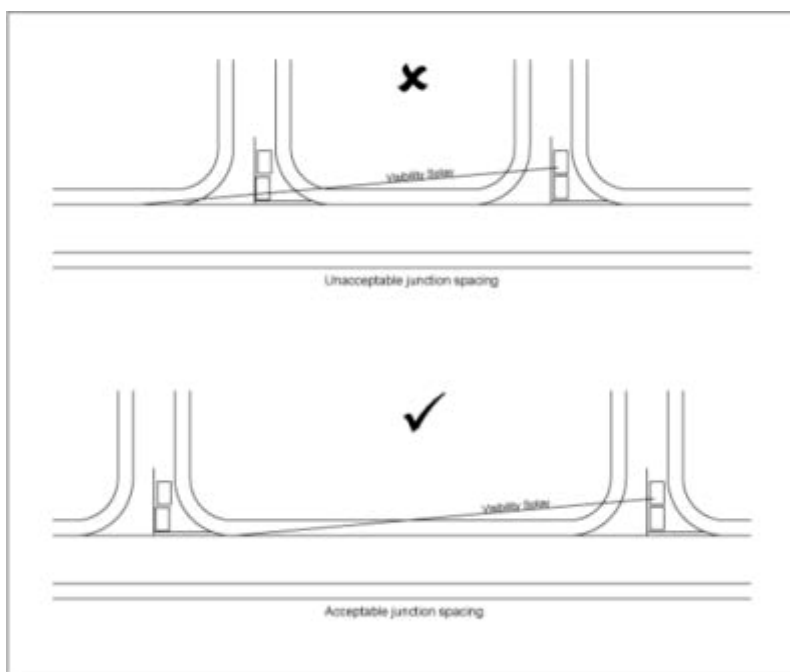

## Private-access restrictions

3.31 There should normally be no accesses for vehicles:

- on to the corners (radii) of the junction;
- at bus stops or lay-bys;
- close to a pedestrian or cycle refuge;
- close to a traffic-calming feature (accesses should not be sited on the ramp of a road hump or speed table due to the risk of a vehicle grounding as it manoeuvres into or out of the access); and
- close to street furniture.

3.32 Elsewhere, we will normally accept accesses as long as they meet safety considerations and comply with the guidance on the design of private accesses and areas set out in [Section DG18](#) and [Section DG19](#).

## Widening on bends

3.33 On residential roads serving more than 25 dwellings, carriageways should normally be widened at bends that curve through more than 10 degrees.

**Table DG6: Residential roads – widening on bends**

Centre-line radius (m)	20	30	40	50	60	80
Minimum widening	0.60	0.40	0.35	0.25	0.20	0.15

## The 6Cs Design Guide

3.34 Bends should normally be widened in industrial and commercial developments.

**Table DG7: Industrial and commercial roads – widening on bends**

<b>Centre line radius (m)</b>	55 to 74	75 to 89	90 to 150
<b>Minimum widening</b>	1.2	0.7	0.6

3.35 For any proposals not conforming to the figures in the above table, you will need to produce computerised vehicle-path assessments to show that the proposed layout can accommodate appropriate vehicles without danger to other road users, including pedestrians and cyclists.

### Turning heads

3.36 A turning head should normally be provided at the end of all cul-de-sacs or wherever vehicles would otherwise have to reverse over long distances – normally anything over 25m, in line with [BS5906, 1980](#). You should also provide turning heads where turning vehicles might damage adjacent verges or footways. Figure DG4 shows minimum turning dimensions and areas. It may be necessary to provide tracking details for turning heads to ensure that a specified Waste/Recycling vehicle can negotiate a turning area satisfactorily.

For further information, including on vehicle specification, please contact the relevant Authority.

3.37 You should give careful consideration to the design of the development surrounding the turning head to make sure that its use is not reduced by on-street parking. Where on-street parking is likely to cause problems, we will normally expect you to provide measures to control it (see Section DG14, in particular [paragraphs 3.192](#) onwards).

3.38 We will consider larger areas, such as residential squares, which provide the minimum turning dimensions as long as their use as a turning head would not be affected by on-street parking. You would also be required to provide clear details of who is responsible for maintenance. Where it is intended that we [adopt](#) any extra areas over the normal minimum, we may require you to pay [commuted sums](#) for future maintenance (see [Part 4 Section MC18](#)).

# The 6Cs Design Guide

**Figure DG4 Turning heads**

**Figure DG4a Example of a turning head within a 'square'**



This is an example of a highway square which forms the end of a road and a turning area. The area must be proven through tracking to allow turning. The edge of any turning area need not be demarcated on site.

## The 6Cs Design Guide

**Figure DG4b Turning heads for use on residential access roads and minor industrial access roads serving offices**

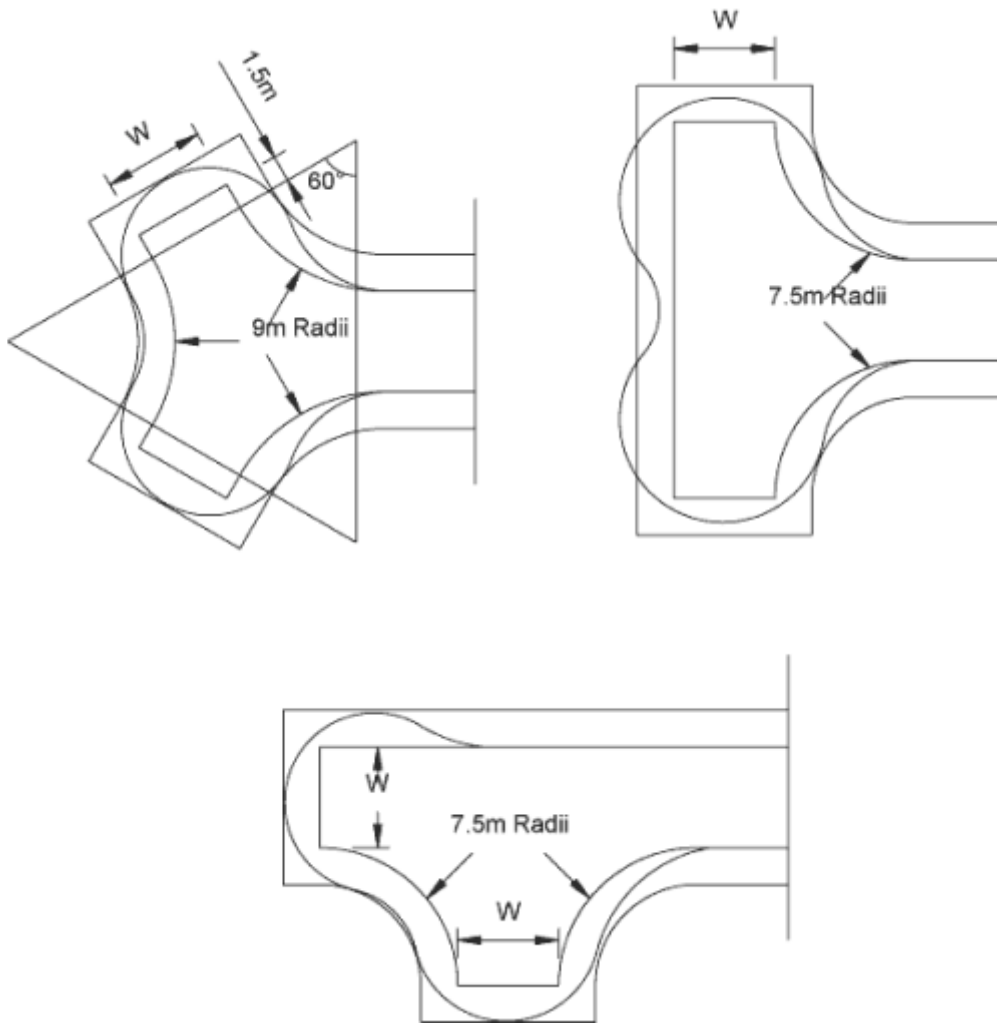

W = 4.8m up to 50 dwellings

W = 5.5m from 50 - 400 dwellings

W = 6m for B1 [use class](#) office developments

# The 6Cs Design Guide

**Figure DG4c Turning heads for use on industrial/commercial estate roads**

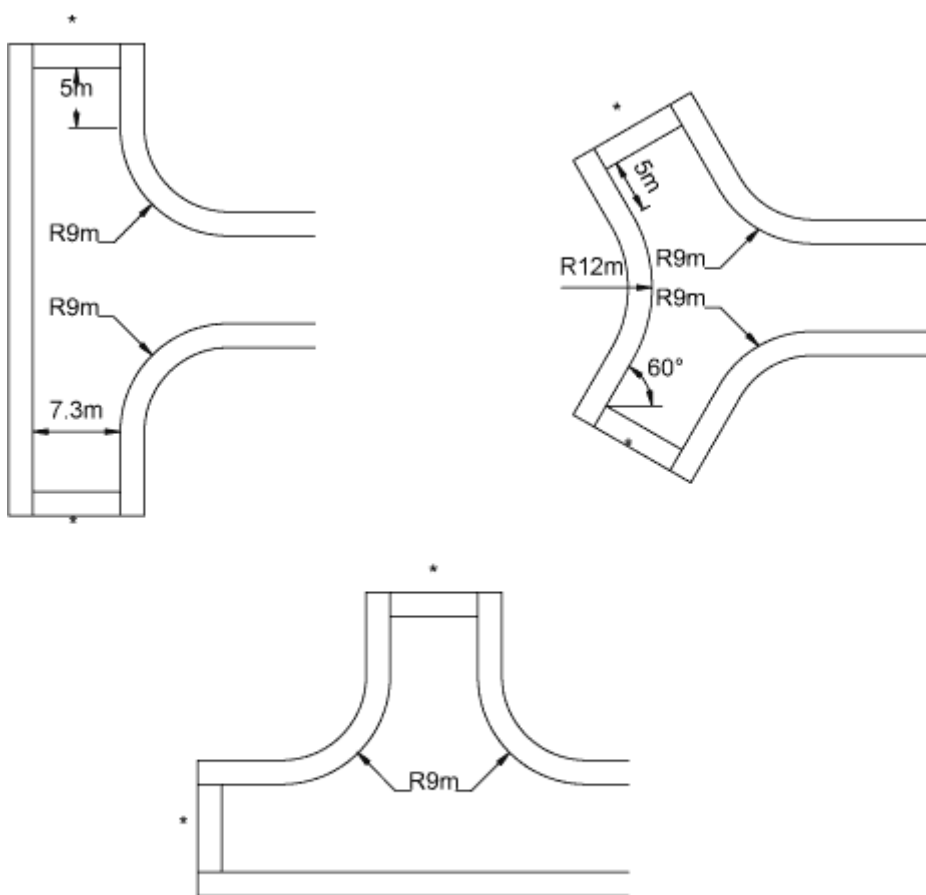

\* Depending upon the type of vehicles likely to use the road, a footway may be required around the end of the turning head.

## Materials and construction

3.39 Please refer to [Part 4](#). The standard construction requirements and materials set-out in this Part are based on national standards and advice used in general for constructing and maintaining highways throughout Leicestershire, Derbyshire and Nottinghamshire. They should normally be applied to **all** highway works and have been chosen to make sure the highways function safely and to make sure that they can be maintained in the most cost-effective way. To achieve these ends, we have considered the principles of quality, durability, maintainability and sustainability.

However, it is recognised that each Authority has regional variants in its palette of construction materials that should be used in such places as City Centres/ Conservation areas. Reference should always be made to the relevant Authorities website for local advice on construction materials. For example, in Nottingham City please refer to the Nottingham City Centre Streetscape Design Manual.

## Adopting new roads

3.40 We will normally adopt a new road where:

## The 6Cs Design Guide

- it serves more than five dwellings or serves a multiple building and multiple-occupation industrial or commercial development;
- all highway works have been designed and completed to our satisfaction;
- an agreement under S104 of the Water Industry Act has been signed with the [relevant water company](#) for the road's drainage to be adopted, or alternatively we are satisfied to adopt the drainage; and
- the development served by the road is acceptable in all other highways and transportation respects, for example in terms of parking provision.

3.41 Please see [Part 5](#) for details of adopting roads under a Section 38 agreement of the Highways Act. In this Part, [Section DG18](#) gives guidance on the layout of private roads and areas in residential developments and [Section DG19](#) gives guidance on the layout of industrial and commercial developments.

3.42 In some cases, [commuted sums](#) may be payable. For example this will normally be for:

- additional areas exceeding usual highway design standards and which are not required for the safe functioning of the highway;
- materials outside our usual Specification;
- non-usual or additional street furniture;
- landscaping within the proposed highway, including trees; and
- sustainable drainage systems (SUDS), for example, flow-attenuation devices, swales and storage areas for highway drainage.

Note:

Where you are proposing SUDS, you must hold discussions with all relevant parties at an early stage (and certainly before any planning application) to agree ownership and responsibility for the facility.

This is not an exhaustive list, and there are other occasions described throughout this document where we require the payment of commuted sums, for example vertical traffic calming.

3.43 Please refer to [Part 4](#) for further details of where commuted sums will normally be payable and for details of how they are calculated.



# The 6Cs Design Guide



## Section DG3: Home Zones

- [Principles](#)
- [The legal framework](#)
- [General design considerations](#)
- [Adopting new Home Zones](#)

### Principles

3.44 '[Home Zone](#)' is the term used for a street where people and vehicles share the whole of the road space safely and equally.

3.45 Home Zones are based on a change in the way that people regard the street. Motorists should feel that they have left the normal highway and have entered an area where they can expect to find people who are using the whole of the street. Simply, Home Zones should make motorists feel they are guests in a pedestrian environment, and they should drive accordingly.

3.46 Home Zones may consist of shared surfaces, indirect traffic routes, areas of planting and features such as seating to encourage people to use the street. Entry gateways and signing will be needed to mark the limits of the area.

3.47 Home Zones are a relatively new idea in the UK, and some of the legal regulations to introduce them have only recently been put in place.

### The legal framework

3.48 Section 268 of the [Transport Act 2000](#) provides the legal basis for establishing Home Zones in England and Wales. It permits local traffic authorities (us, in this case) in England and Wales to designate any street or streets as a Home Zone. However, this in itself does not change the legal use of the highway. This can only be done by local authorities making use orders and speed orders for designated Home Zones.

3.49 The Secretary of State has recently made the necessary regulations under the Transport Act setting out the procedures for designating Home Zones and making use orders and speed orders. A use order will allow activities other than moving vehicles (such as children's play), to take place legally on streets. A speed order will allow the traffic authority to define an appropriate design speed for the Home Zone.

3.50 We will consider proposals for Home Zones on a site by site basis.

### General design considerations

3.51 If you want to progress proposals that include Home Zone concepts, you should discuss your ideas with us and the planning authority at the earliest opportunity and before

# The 6Cs Design Guide

you submit a planning application. You should also take account of the following general design considerations.

## 3.52 Location

- No areas Derbyshire, Leicestershire and Nottinghamshire are specifically excluded in principle. However, Home Zones are likely to be most appropriate in more urban areas that are well served by public transport and where car ownership may be lower than in more rural areas.
- Indications are that Home Zones may be less appropriate in housing-association and social-housing developments.

We will consider Home Zones in principle off any class of road, subject to our access policy in [Part 1](#) of this document. Where accessed off a classified (A, B or other classification) road or off a busy unclassified road, the junction must be formed in line with the Design Manual for Roads and Bridges and there must be a [length of access road](#) between the site access and the beginning of the Home Zones. The length of the access road will depend on the speed and flow of traffic on the main road, the size of the Home Zone and local topography. Each site will be considered on its merits. Home Zones on other classifications of road may normally be served by a dropped-kerb arrangement.

- It will not normally be appropriate for Home Zones to form part of a bus route.

## 3.53 The scale of development

- We will normally only consider Home Zones for small-scale pockets or cells of development where traffic flows are likely to be low. This applies either to a small free-standing development or any part of a large development.
- Home Zones are particularly appropriate for cul-de-sacs and small loop roads where there is little 'extraneous' traffic (traffic from outside the development). You should avoid layouts that could result in 'rat-running'.
- Normally there should be no more than 25 dwellings in each cell for a cul-de-sac and 50 dwellings where there is any form of route for vehicles through it. These limits are not intended to rule out larger developments consisting of a number of Home Zones. Cells can be arranged to form larger Home Zone developments linked by routes that allow people and vehicles to move round the development.

# The 6Cs Design Guide

Figure DG5 Home Zones arranged to form a larger development

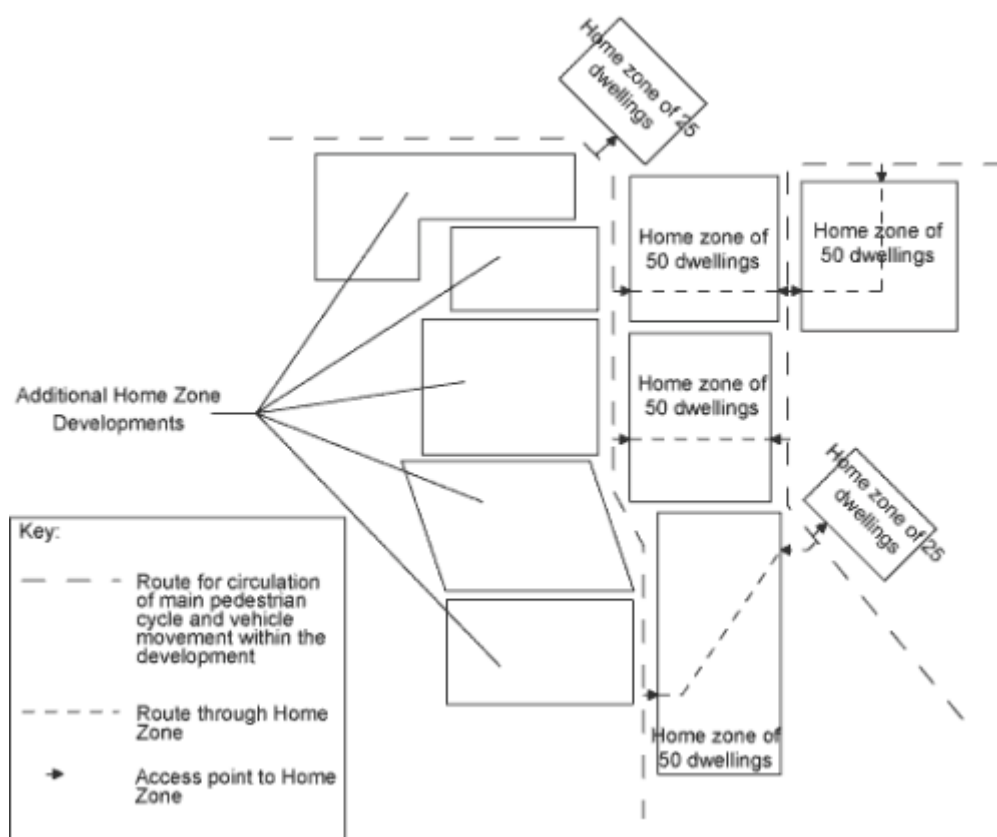

## 3.54 Layout

- The normal 85th %ile design speed will be assumed as 15mph, with a corresponding minimum visibility splay of 17m. We will be prepared to consider lesser visibility splay if we are satisfied that the proposed layout will achieve lower overall traffic speeds.
- You must pay particular attention to:
  - methods of controlling entry speeds to the Home Zone;
  - the width for each area in the development to allow vehicles, pedestrians and cyclists to use it safely;
  - making sure vehicles keep to the intended design speed, preferably through the design and layout of buildings and areas in between or, where necessary, by using speed-control features (with vertical features such as road humps as a last resort);
  - making the design safe for blind or partially-sighted people and those with impaired mobility;
  - accessibility for servicing vehicles, for example refuse-collection vehicles and meeting the requirements of [British Standard BS5906, 2005](#), which sets the maximum distances for carrying refuse at 25m;
  - accessibility for emergency vehicles, including meeting with any requirements of [BS5906, 2005](#) and the [Building Regulations Approved Document B, Fire Safety 2006](#);

# The 6Cs Design Guide

- reducing the risk of accidents between vehicles and other highway users by making sure that there is appropriate inter-visibility (road users are clearly visible to one another);
- clearly defining the extents of the public highway;
- providing utility equipment (for example, gas, water, cable TV) and making sure access for maintenance disrupts the highway as little as possible; and
- providing clearance for opening windows, drainage downpipes and overhanging eaves where buildings front directly on to the highway.

3.55 So we can properly and efficiently consider any development proposals that either are, or include, a Home Zone, you must submit a concept proposal and supporting information in line with [Part 2](#) of this document.

3.56 We will continue to review our guidance on Home Zones in the light of any new national guidance and practical experience gained.

## Adopting new Home Zones

3.57 We will normally adopt a new [Home Zone](#), subject to the requirements in [paragraph 3.40](#) onwards.

## Section DG4: Mixed-use developments

3.58 Wherever possible, in the interests of road safety and to reduce environmental impacts, commercial and employment developments that generate larger goods vehicles should be kept separate from residential areas. You should design layouts so this type of commercial and employment traffic does not need to use residential roads. Similarly, Home Zones cannot be used to access these developments.

3.59 To support sustainable development, we may accept mixed-use developments that include small developments that generate very few goods vehicles, such as offices or a shop, particularly in or close to town centres.

3.60 Where a mixture of residential and commercial traffic is likely to use a road, the design elements, including materials and construction, should be based on the largest vehicles likely to use any particular section of the road.

3.61 We will normally [adopt](#) road layouts in mixed developments subject to the requirements in [paragraph 3.40](#) onwards.

# The 6Cs Design Guide



## Section DG5: Speed control

- [Internal roads](#)
- [The existing external road network](#)
- [Materials and construction](#)

### Internal roads

3.62 For developments outside the cities, vehicle speeds within new developments should normally be controlled through the design and layout of the roads and the locations of buildings and not normally by using traffic-calming features (particularly vertical features such as road humps). Within the city areas, all new developments should be designed so that a 20mph zone can be introduced and vertical traffic calming may be used to achieve this. You should avoid:

- long straights;
- shallow bends
- roads wider than the requirements for the safe and satisfactory passage of all road users; or
- development layouts that provide greater visibility than recommended in this guidance.

You should break up stretches of straight road by either junctions or 90-degree bends as shown in [Figure DG6](#).

3.63 Where there are valid reasons why vehicle speeds cannot be controlled through site layout, and traffic calming measures are required, in the county areas you should consider horizontal measures first and you should use vertical measures only as a last resort. There is greater flexibility to use vertical measures in the cities. We will normally require commuted sum payments to cover future maintenance (see [Part4 Section MC18](#)). Some examples of measures are shown in [Figure DG6](#). Any traffic calming should normally be in accordance with advice contained in Department for Transport Traffic Advisory Leaflets as [listed in Part 9](#).

3.64 Take particular care over choosing any type of traffic-calming measure on a proposed bus route (see Section DG6, in particular [paragraphs 3.98](#) onwards).

3.65 You must take particular care on key routes that are used or are likely to be used by the emergency services. While certain types of traffic calming (particularly vertical measures such as road humps) can have potential road safety benefits, they can also adversely affect the response times of emergency vehicles. Where traffic calming is proposed on a key route, you will need to consult the emergency services at a very early

## The 6Cs Design Guide

stage (and certainly before you submit any planning application) and you will need to work closely with them in the design of any measures.

**Table DG8: Maximum lengths of straight for vehicle speed control** <sup>(a)</sup>

Maximum length of straight <sup>(a)</sup>	
85th %ile design speed (mph)	Maximum distance <sup>(b)</sup> (metres)
30	150
25	100
20	60
15	40

(a) This is the maximum distance between junctions, 90-degree bends or a speed control feature

(b) Distance between curves is measured between the tangent points.

3.66 Where any form of vertical calming feature is proposed, you should not site it within 25m of the edge of a structure, for example, a bridge or culvert. You should also site such features clear of private accesses and driveways to avoid problems of vehicles 'grounding' as they turn into or out of the accesses or drives.

3.67 We will be prepared to consider other methods of vehicle speed control in the light of practical experience of their effectiveness and any further research. However, because of problems with noise and vibration, we will not normally accept 'rumble strips'.

**Figure DG6 Some examples of speed control features**

# The 6Cs Design Guide

**Figure DG6a Speed control bend (please also see [Part 4, paragraph 4.91](#))**

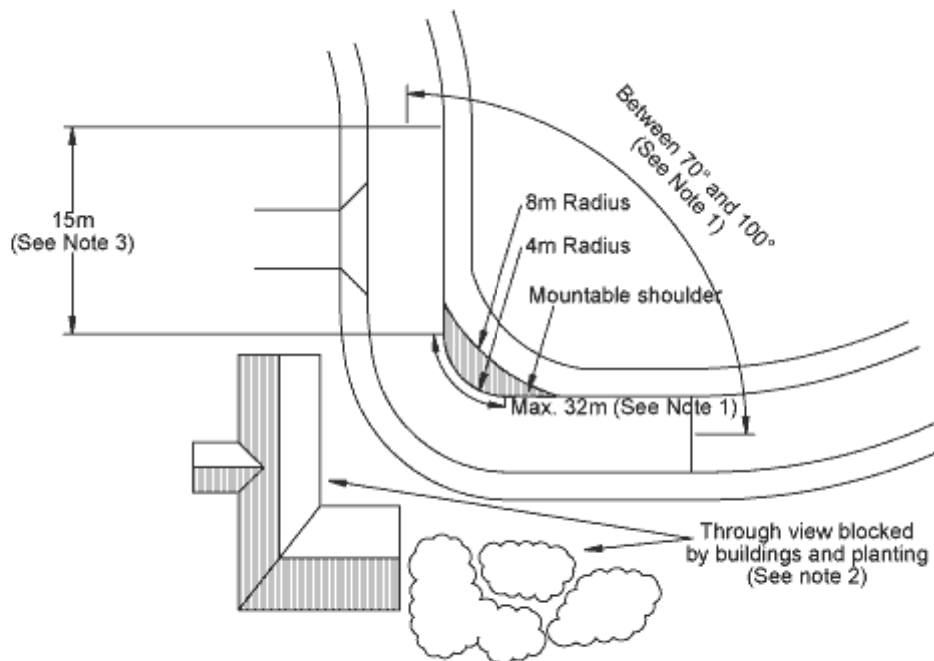

**Notes:**

1. Change in direction to be between 70° and 100° over a maximum distance of 32m measured along the inside kerb.
2. The through view beyond the bend on to the approach should be blocked by buildings, walls or dense planting etc.
3. A 15m separating straight is required after the speed control bend if the road curves in a reverse direction
4. There should be no vehicular accesses over the length of the forward visibility curve

**Figure DG6b Chicane**

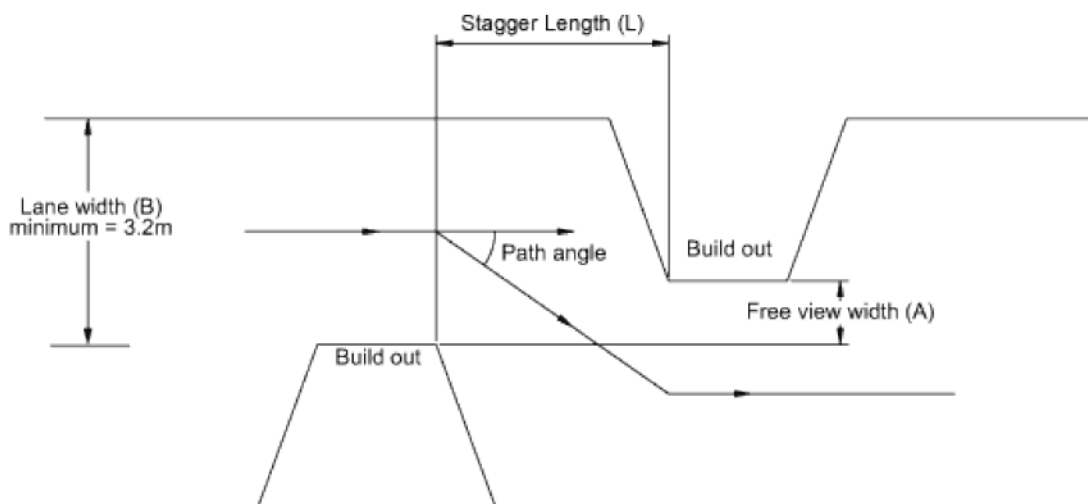

- Free View Width (A) - The width of the central gap between build outs on opposite sides
- Lane Width (B) - The average width between the build out and the opposite kerb
- Stagger Length (L) - The length between the start of the stagger on the offside and the end of the stagger on the nearside
- Path Angle - The angle through which the traffic lane is displaced. This should be minimum of 20° for design speeds of 15mph and a minimum of 15° for design speeds of 25mph

# The 6Cs Design Guide

Stagger length and car speeds and Minimum dimensions of stagger length for larger vehicles

Lane width 'B' (metres)	Free view width 'A' (metre)	Stagger length 'L' to achieve the required vehicle speed in chicane 15 mph	Stagger length 'L' to achieve the required vehicle speed in chicane 25 mph		Stagger length 'L' (m) needed for a free view width of 0.0m	Stagger length 'L' (m) needed for a free view width of 0.0m	Stagger length 'L' (m) needed for a free view width of 0.0m
3.2	+1.0	6m	14m	Lane width	3.2m	3.5m	4.0m
	0.0	9m	18m				
	-1.0	12m					
		9m 11m	11m 15m 19m	Artic lorry	20	15	11
3.5	+1.0		9m	Rigid lorry	12	9	7
	0.0		12m				
	-1.0		15m				
				Single decker bus	13	11	9

Figure DG6c Example of chicane including cycle 'bypass'

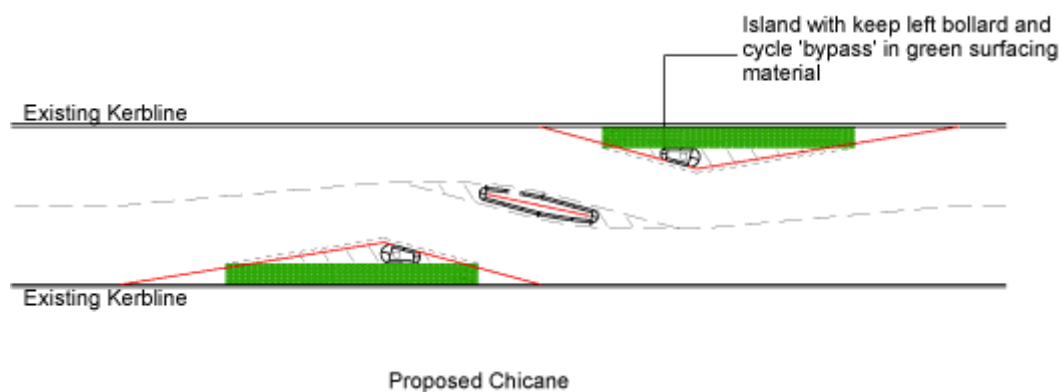

Note: Length of cycle lane to be agreed



# The 6Cs Design Guide

**Figure DG6d Junction table (please also see [Part 4, paragraph 4.86](#))**

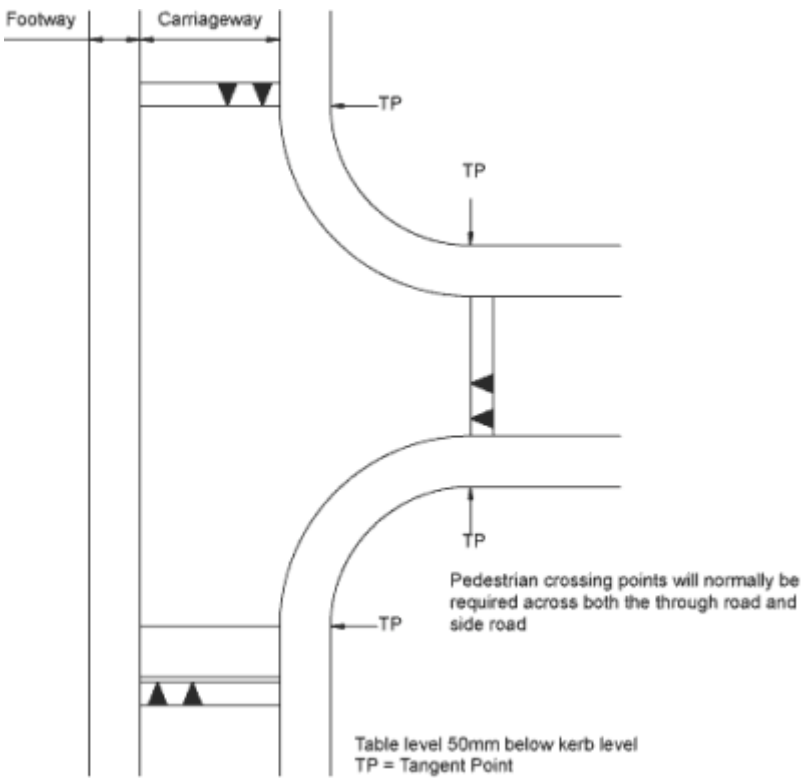

**Figure DG6e Cross section of speed tables with alterations for steep roads shown in lower diagram (please also see [Part 4, paragraph 4.86](#))**

All construction joints to be saw cut and painted with bitumen in accordance with BS594 part 2

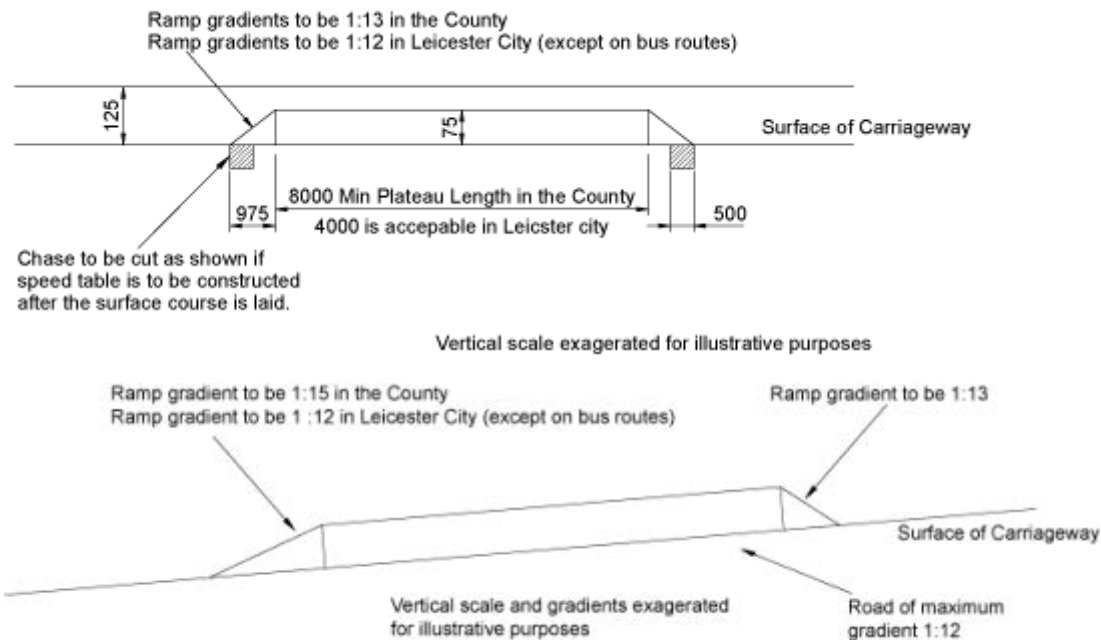

# The 6Cs Design Guide

**Figure DG6f Example of vehicle speed control by development layout**

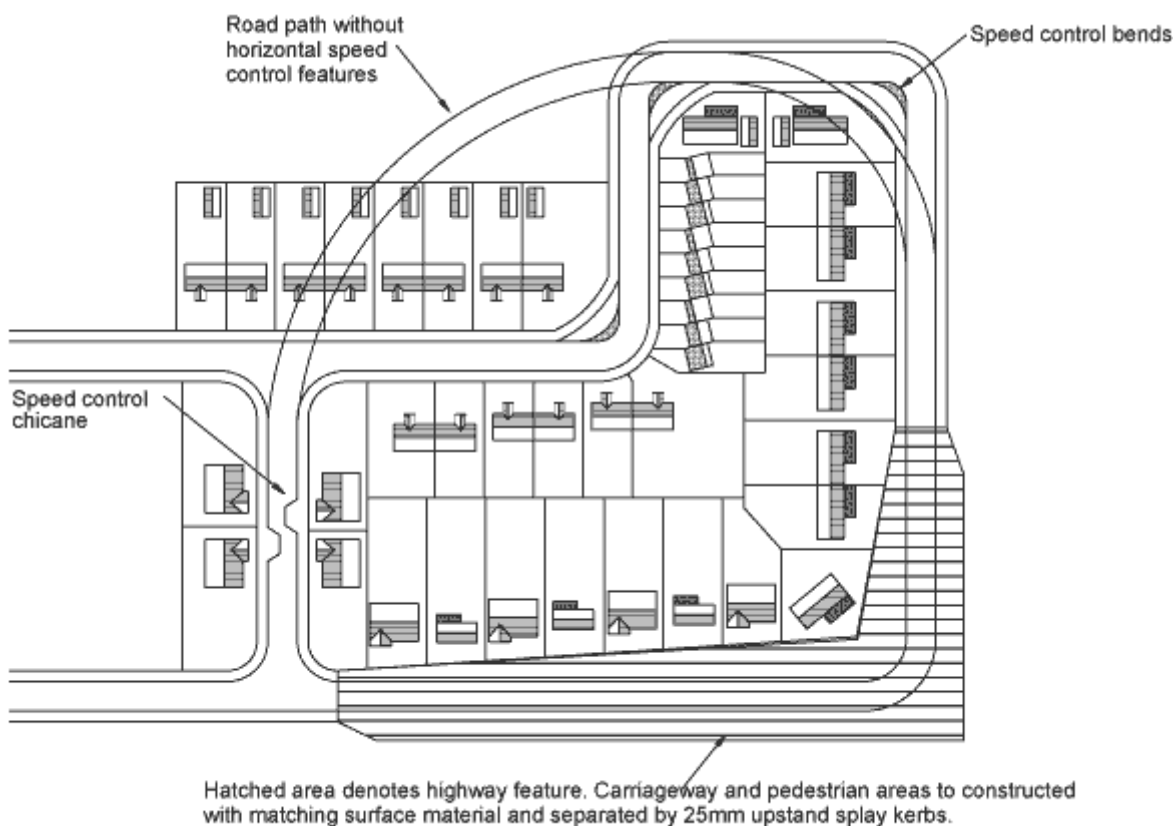

Note: Please see our [standard drawings](#) for junction tables, speed cushions and road humps.

## The existing external road network

3.68 Where a development requires speed-control measures on the existing external highway network, for example, to help minimise its impacts or to achieve safe site access, there will have to be an additional public consultation separate from the planning process including advertising of features and where appropriate a different speed limit. These separate consultations are required even where the development has received planning permission. Because of problems with noise and vibration, we will not normally accept 'rumble strips'.

3.69 These consultations can often be an extensive and lengthy process, particularly where statutory procedures are involved. You will normally be required to fund all costs associated with these consultations.

3.70 We will normally seek to secure the speed-control measures and the funding of any associated costs through an appropriate legal agreement.

3.71 You should get early advice on the likely timescale and procedures involved for your specific proposals. Take this information into account when you draw up the programme for your proposed development and in any negotiations that you may have with the landowner of the development site.

# The 6Cs Design Guide

In Leicester City, on residential distributor roads vertical features can only be introduced after discussions with the appropriate Cabinet Lead. Speed cushions are normally preferred for residential distributor roads. However, if road humps are the only solution these should be a maximum of 65mm in height (possibly 75mm subject to agreement) and over 7m in length (only on bus routes). All traffic calming installed on the existing road network as part of a s278 agreement should include a speed reduction feature prior to any vertical feature where the 85<sup>th</sup> percentile approach speed is greater than 30mph.

## Materials and construction

3.72 Please refer to [Part 4](#).



## Section DG6: Public transport

- [Introduction](#)
- [Bus services](#)
- [Pedestrian access to bus routes](#)
- [Bus stop location and design](#)
- [Designing bus routes](#)
- [Bus-only links](#)
- [Public-transport interchanges](#)

### Introduction

3.73 In the interests of sustainability, new development should be located in areas well served by alternative means of transport to the private car, including buses, taxis and cycle routes.

3.74 Particularly if your development requires any form of transport assessment (see [Part 2 Table PDP1](#)), you should seek early advice from us and bus operators on:

- existing bus services in the area, and any proposals to upgrade services or facilities, for example, introducing the real-time bus information system 'star trak';

(A system which provides waiting passengers with details of when the next bus is due and the route number. This is known as 'real-time information', and the system currently used in Leicester, Leicestershire, Nottinghamshire and Derbyshire is 'star trak'.)

- how best to serve the proposed development, for example, how appropriate would it be to:
  - operate a bus service through the development (bearing in mind the walking distance guidance in [paragraph 3.81](#) below); or

## The 6Cs Design Guide

- enhance existing services adjacent to the development and provide improved footway links to the bus stops;
- where a service is to operate through the development, how best to plan a route and where best to locate bus stops and any lay-bys to encourage maximum use of the service; and
- what other measures might be required to improve public transport provision, for example, more frequent services or improvements to existing bus stops.

3.75 You should discuss these issues and agree the general approach as soon as possible as the outcomes are likely to have a bearing on:

- the development's layout;
- the transport assessment;
- any travel plan;
- any likely highway mitigation works; and
- parking provision.

3.76 Additionally, where a development requires a concept proposal (see [Part 2 paragraph 2.17](#)), you should clearly identify and detail any agreed public transport facilities and routes.

### Bus services

3.77 Where you are proposing public transport as a sustainable alternative to using cars, the service must realistically be capable of delivering a shift away from the car. To achieve any significant shift, it is likely that the service will have to be more frequent than once an hour during the day, Monday to Saturday, with an evening and Sunday service for larger developments.

3.78 We will consider developments on a site-by-site basis. We will assess any estimates for likely levels of public transport use included in any transport assessments or draft travel plans, against existing or proposed bus routes, vehicle capacities and timetables. We will need to be satisfied that a public transport service can be provided that is realistically capable of achieving the proposed level of use by the development's occupants.

3.79 We will also consider any phasing in of services, particularly for larger developments, on a site-by-site basis. Issues that will need to be discussed and agreed include:

- the initial service provision to a development site, for example, taxibuses and demand-responsive transport (services that operate in response to specific requests from residents) to serve the first occupiers of new residential developments;
- at what stage the growing numbers of houses, employees and shoppers will trigger an increase in the capacity and frequency of services;
- the need for priming initial services by using subsidised or free bus passes, residents' travel packs and so on; and
- if and when a new service might become self-funding.

3.80 Through the planning process we will normally recommend to planning authorities that developers fund public transport services through a Section 106 agreement which, among

# The 6Cs Design Guide

other things, specifies the level of support which must be provided to the service and over what time period. While we will seek to work with you to reach a suitable agreement, we will resist (for example by recommending refusal of any planning application) development proposals that do not meet the policies and objectives set out in this document, (see [Part 1, paragraph 1.24](#) onwards)

## **Pedestrian access to bus routes**

3.81 Generally walking distances to bus stops in urban areas should be a maximum of 400m and desirably no more than 250m. In rural areas the walking distance should not be more than 800m.

3.82 You should design pedestrian routes to bus stops to be as direct, convenient and safe as possible to encourage use of public transport. You should design the routes in line with principles set out in [paragraph 3.111](#). They should:

- enjoy good natural observation from neighbouring buildings;
- be well lit; and
- be carefully designed so any planting minimises opportunities for crime.

You should place bus stops in employment or commercial areas near building entrances and avoid locations where passing traffic speeds are high. In rural areas there should always be at least a footway from any proposed development to the nearest bus stop.

3.83 Where there is a footway on the opposite side of the road, a pedestrian crossing point should normally be provided next to a bus stop, and designed in line with the appropriate [standard drawing](#). The crossing point should be located as close as is possible to the stop, bearing in mind safety considerations.

## **Bus stop location and design**

3.84 You should think carefully about the proposed layout of the development in the immediate vicinity of a bus stop to:

- make sure bus drivers and passengers waiting at the stop have ample time to see each other;
- make sure vehicles overtaking a stationary bus have satisfactory forward visibility;
- prevent parked vehicles blocking bus stops;
- avoid safety conflicts with road junctions, pedestrian or cycle crossings and so on
- avoid interference with accesses to properties;
- make sure there is satisfactory drainage where raised kerbing is installed (see [paragraph 3.88](#));
- minimise risks to personal safety and opportunities for crime, in line with principles similar to those set out in [paragraph 3.111](#); and
- protect bus stops from obstruction.

3.85 You should not site bus stops within 30m of vertical traffic-calming features (including domed mini roundabouts). This is to minimise the risk of passengers waiting to get off the bus being thrown about the inside of the bus, and to allow boarding passengers time to sit down.

## The 6Cs Design Guide

3.86 To erect a new bus stop or relocate an existing bus stop on an existing public highway you need to get agreement from:

- us;
- the police;
- the local parish council (if appropriate) / local ward councillor;
- bus operators; and
- in Leicester City, frontages directly affected must be notified in writing and allowed a reasonable time to respond (usually two weeks).

3.87 The minimum footway width at a bus stop should normally be 3m. Where a shelter is to be provided (see [paragraph 3.89](#)), there should be at least 0.5m clearance between any part of the shelter and the edge of the carriageway. There should be a clear footway of at least 1.3m (1.8m in the city) between the shelter and the rear edge of the footway (both for cantilever-style shelters where the roof extends beyond the support and enclosed shelters). Where you cannot achieve this, but there are no alternative locations to site the shelter, then we will consider site-specific shelter designs.

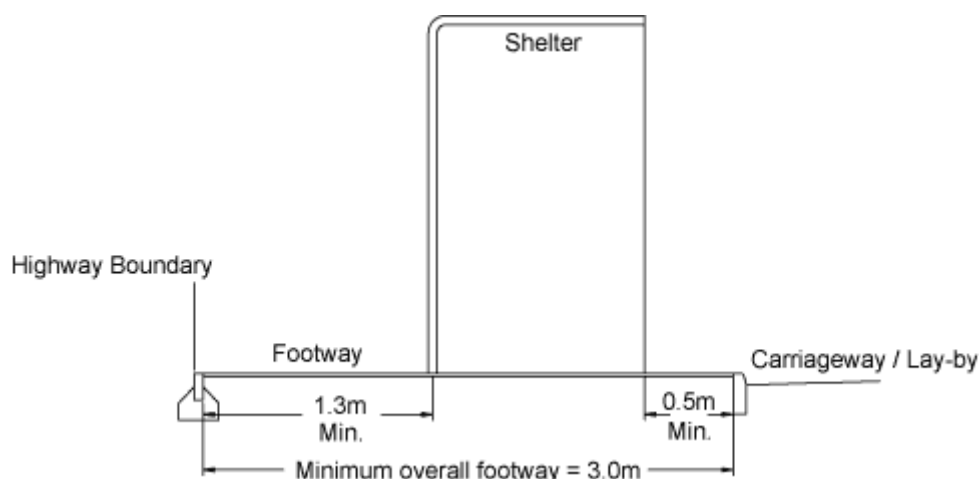

**Figure DG7 Bus shelter siting**

3.88 Accessible raised kerbing to a height of 180mm will be required at all stops. The length of raised kerbing should normally be 6m in the county and 4m in the city (plus 1m transition kerbs at either end) with a minimum run of 3m (plus transition kerbs). The stop should be located and laid out so a bus can stop parallel to and close to the raised kerbing.

# The 6Cs Design Guide

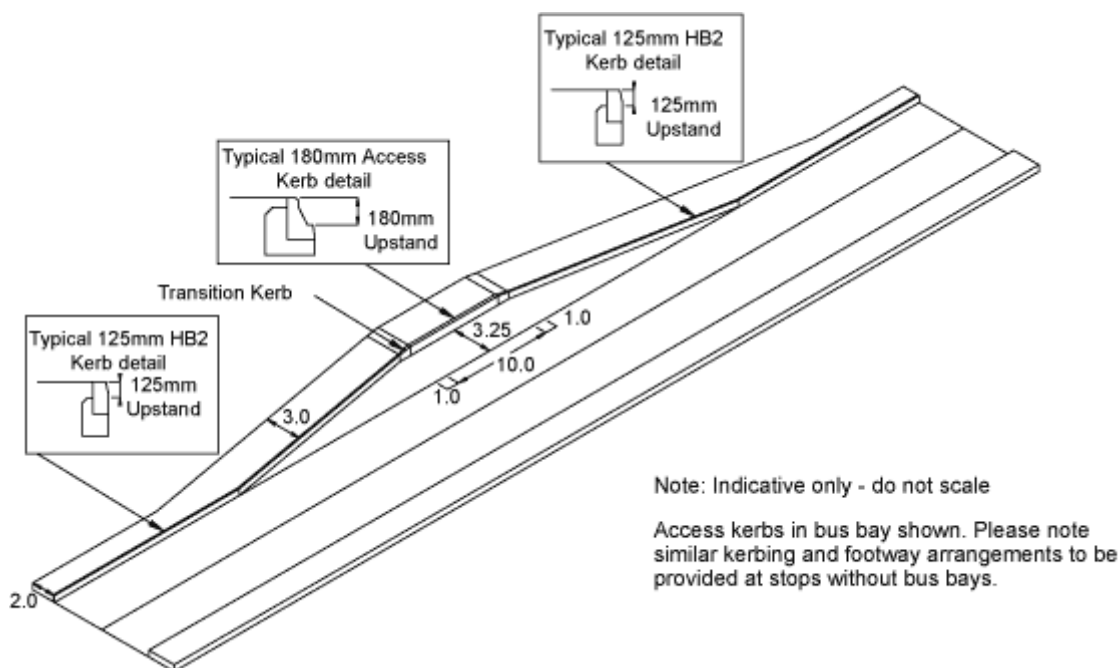

**Figure DG8 Raised kerbing at bus stops**

3.89 Shelters will usually be required at key access points where there are likely to be higher passenger flows, for example, near:

- high-density housing;
- business parks;
- local shops, schools, hospitals or other significant community facilities; or
- in rural areas where public transport services are infrequent and people may have to wait some time for a bus.

3.90 Where we will not own a bus shelter, you will need a license from us to erect it. Where shelters will display advertising, you will also need planning permission from the planning authority. We will also need to be satisfied that appropriate arrangements are in place for the shelter's future maintenance.

Note: in Leicester City new bus shelters may only be introduced through the contract we have with JC Decaux. All installation and maintenance costs will be met by the developer.

3.91 We will consider how bus service information will be provided at bus stops on a site-by-site basis. Depending on the nature and size of the development, the information provided could consist of:

- a simple timetable;
- a more comprehensive display including a bus route map and a plan showing pedestrian links to surrounding facilities; or
- real-time bus information for key stops.

## The 6Cs Design Guide

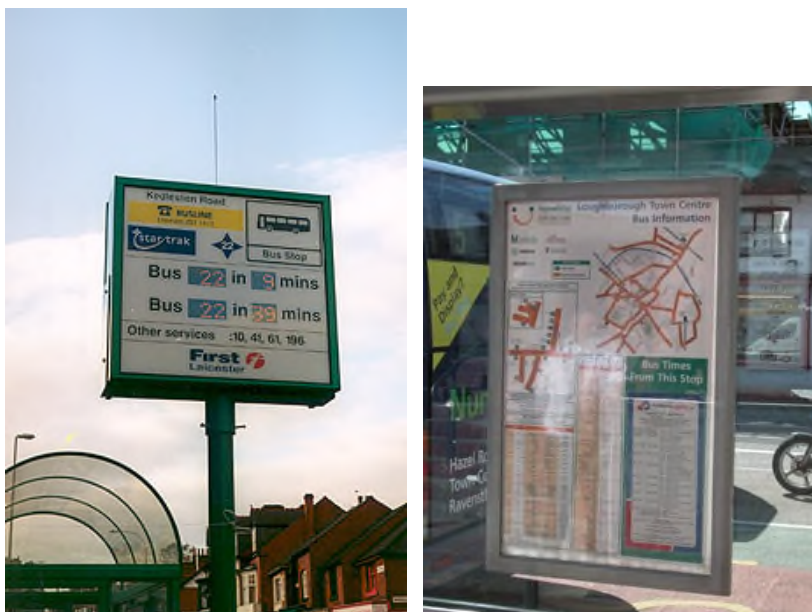

**Figure DG9 Examples of bus service information**

3.92 Lay-bys will normally only be required at places where a large number of people will want to board a bus such as local shops, schools or other locations where buses may wait for a time and could cause localised congestion or be a safety hazard.

3.93 Where lay-bys are to be provided, they should normally be designed to accommodate 15m long buses as indicated in Figure DG10 below.

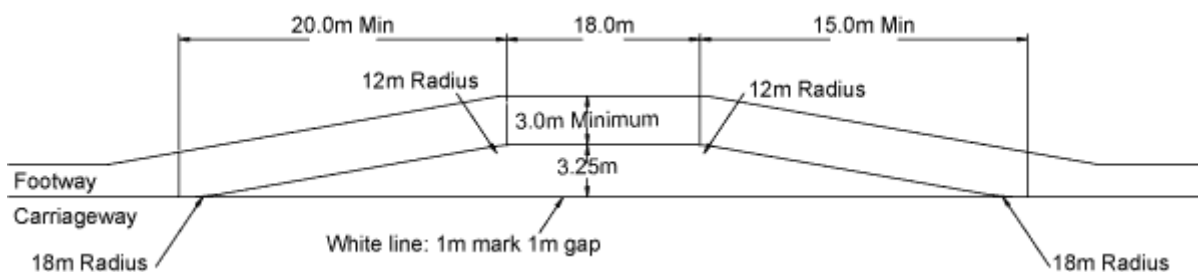

**Figure DG10 Bus lay by**

3.94 When the development is being constructed, you should, where appropriate, make provision for shelter lighting and real-time bus information facilities to be installed at a future date. This should include, for example, installing suitable underground ducting.

3.95 We will normally require a [commuted sum payment](#) to cover future maintenance of bus stop facilities that we are to maintain. Please see [Part 4](#) for further details.

### Designing bus routes

3.96 Where a development is likely to be accessed using public transport, any roads which buses are likely to run along should normally be at least 6m wide (subject to [tracking assessment](#)) and should be reasonably straight. A more generous [swept path](#) is also likely to be required to take account of where vehicles might park on-street, for example. It will not be acceptable to route bus services along either shared-surface roads (that is, access



# The 6Cs Design Guide

ways, see [Section 3](#) ) or through Home Zones. We may consider exceptions for services operated by smaller vehicles (for example, minibuses) where there is no practical alternative to serving the development by public transport.

3.97 Buses should be able to enter and exit from the development as easily and directly as possible. Where appropriate, bus-priority measures such as bus lanes and traffic signals should be used to help bus movement. You should discuss and agree provision for specific sites with us and bus operators.

3.98 Any horizontal speed-control features, including 90-degree bends and horizontal traffic calming measures ([for example, chicanes](#)), should normally be designed to accommodate the swept path of a 15m long rigid bus (the largest vehicle size now permissible). You should discuss and agree design details jointly with us and the bus operators. You will need to give us computer assessments of vehicle swept paths to demonstrate that your proposals will work in practice.

3.99 You should not use vertical traffic calming on bus routes unless there is no other speed control solution. If there is no suitable alternative you should:

- use round-top humps, 5m long with a sinusoidal profile as described in TRL information note [417](#) (and possibly [377](#));
- build any tables to a minimum length of 9m with 1:13 maximum ramp slopes;
- keep humps or tables no higher than 75mm. Bus companies prefer lower heights and we will consider these on a site-by-site basis, as long as any reduction in height does not significantly affect speed control in the development; and
- consult with bus operators (at the earliest opportunity).

Note: Please see our [standard drawings](#) for junction tables, speed cushions and road humps.

## Bus-only links

3.100 For certain developments, particularly larger sites, providing bus-only links may be appropriate. You should provide these where:

- there is a clear need;
- they will save time over a more indirect route;
- they would benefit integration with neighbouring development; or
- they would help to minimise impacts to an existing bus service.

3.101 You should discuss and agree requirements for specific sites jointly with us and the bus operators. But generally you will need to provide (and pay for) traffic regulation orders (TROs) to restrict the link's lawful use. You also need to consider the following.

- The link's design should be self-enforcing and not simply rely on the TROs to control its use by other vehicles. If it is likely that the link would be used by other traffic, it will normally need an appropriate control system such as an automatic rising bollard.
- Its width will depend on whether the link is to be two-way or one-way or [shuttle-working](#).

# The 6Cs Design Guide

- The link should enjoy good natural observation and not be fronted by blank building walls or enclosed by high boundary walls or fences.
- How best to minimise the impact of the link on existing and proposed properties
- Where possible you should include walking and cycling links to complement it.

3.102 We will normally need a [commuted sum payment](#) to cover the future maintenance of any control systems. Please see [Part 4](#) for further details.

**Figure DG11 Example of a bus only link**

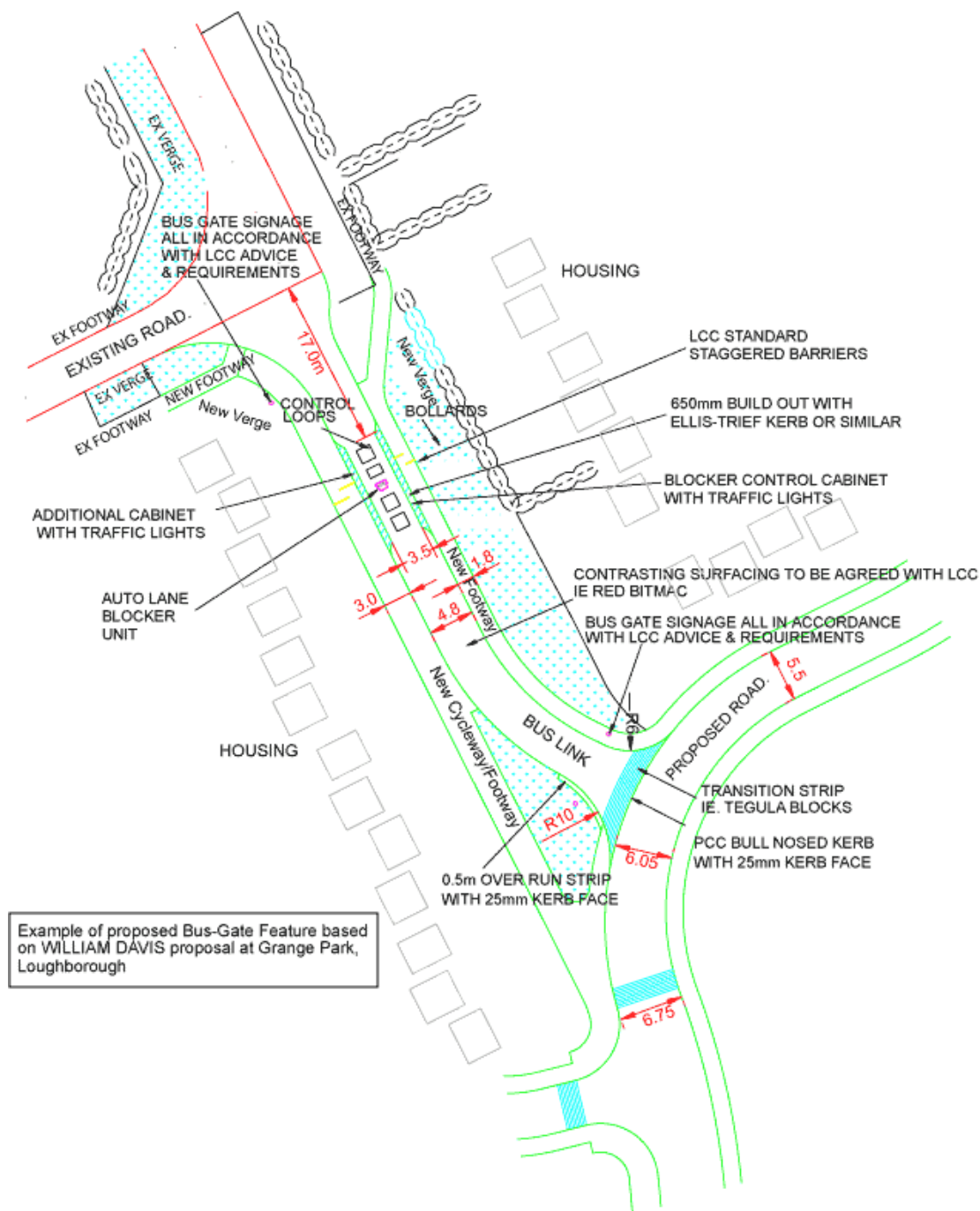

# The 6Cs Design Guide

## Public-transport interchanges

3.103 It may be appropriate for particularly large developments which generate high passenger numbers, and which are located at key points on the road network, to provide a public-transport interchange with comprehensive facilities. Examples of developments and locations might include:

- major retail parks;
- hospitals;
- business parks;
- significant new housing estates;
- extensions to an existing major development where it will help to encourage greater use of public transport;
- developments at locations where bus routes intersect; and
- where major orbital and radial roads intersect.

3.104 Examples of facilities might include:

- a waiting room or mini bus station;
- comprehensive timetable and route information, including real-time bus information;
- secure facilities for leaving luggage;
- toilets;
- refreshment facilities; and
- secure cycle parking.

3.105 We will consider development proposals and maintenance responsibilities on a site-by-site basis.

# The 6Cs Design Guide



## Section DG7: Pedestrians and cyclists

- [Introduction](#)
- [General geometry](#)
- [Road crossings](#)
- [Signing for routes](#)
- [Materials and construction](#)
- [Adopting new routes](#)
- [Existing rights of way](#)
- [The existing and planned cycle route network](#)
- [Providing cycle parking and other facilities for cyclists](#)

### Introduction

3.106 Walking and cycling offer real alternatives to journeys by car particularly over shorter distances. In the interests of sustainability new developments must make appropriate, high quality provision for pedestrians and cyclists and where it is necessary to break a road link in order to discourage through traffic, it is recommended that links for pedestrians and cyclists are maintained. In respect of cycling, this includes provision of appropriate parking and supporting facilities (for example showers and lockers) as detailed in [Section DG16](#).

### General geometry

3.107 Table DG9 sets out general geometry for pedestrian-only routes, including [footways](#) and [footpaths](#). Routes for joint use by pedestrian and cyclists, or by cyclists only, are covered in Table DG10. Surfaces used by pedestrians should be free from hazards that could cause them to trip.

# The 6Cs Design Guide

**Table DG9: Pedestrian-only routes**

Location	Minimum width	Minimum width past an obstacle <sup>(a)</sup>	Longitudinal gradient	Crossfall
Normal residential, commercial and industrial sites	2m	1.2m Maximum length of an obstacle: 6m	Minimum:1:100 Maximum:1:20 <sup>(b)(c)</sup>	1:35
Shopping areas	4m	1.2m Maximum length of an obstacle: 6m	Minimum:1:100 Maximum:1:20 <sup>(b)(c)</sup>	1:35
Bus stops	3m	1.2m Maximum length of an obstacle: 6m	Minimum:1:100 Maximum:1:20 <sup>(b)(c)</sup>	1:35
Outside schools <sup>(d)</sup>	3m	1.2m Maximum length of an obstacle: 6m	Minimum:1:100 Maximum:1:20 <sup>(b)(c)</sup>	1:35

(a) Includes things such as bollards, sign posts, guard railing, lamp columns and utility equipment (for example gas, water, cable TV). You should liaise with utility providers to achieve this for equipment installed while the development is being built. The clearance should be increased to 2m where pedestrian flows may be heavy, in the region of 500 an hour. Please see [Section DG11](#) for more guidance on locating utility equipment.

(b) Taking into account the needs of people with impaired mobility, we may be prepared to consider a relaxation to 1:12 on sites with particularly difficult topography.

(c) Crossovers to private drives and parking should be carefully designed so as not to create inconvenient cross-falls for pedestrians.

(d) Includes [higher and further education facilities](#).

**Table DG10: Joint use of cycle and pedestrian routes and cycle-only use**

Type <sup>(a)</sup>	Width <sup>(b)</sup>	Centre-line radius	Forward visibility	Crossfall <sup>(d)</sup>	Longitudinal gradient
Joint use with pedestrians	3.0m <sup>(e)</sup>	6m	20m	1:35 (no adverse camber)	Min: 1:100 Max: 1:20
Cycle only	2m <sup>(e)</sup>				

(a) Normally provide joint use, except where cyclist and pedestrian flows are likely to be high, for example, outside a school or in a shopping area. Where cyclists and visually-impaired pedestrians could meet, you should provide warning surfaces to [standard drawings](#)

## The 6Cs Design Guide

- (b) Minimum width past an obstacle as in Table DG9 above, including accompanying note.
- (c) A 50mm white line should be provided, offset 500mm from the kerb and parallel to it.
- (d) Crossovers to private drives and parking areas should be carefully designed so as not to create inconvenient cross-falls for pedestrians.
- (e) Where a route is bounded (for example by a wall, fence or bridge parapet) you should normally add an additional 0.25m for each side bounded where the boundary height does not exceed 1.2m, and an additional 0.5m for each side bounded where the boundary height exceeds 1.2m.

3.108 Please contact the relevant authority for cycling design advice.

3.109 Porch roofs, awnings, garage doors, bay windows, balconies or other building elements should not oversail (project over) footways at a height less than 2.6m; the headroom over routes used by cyclists should normally be 2.7m. If any part of a building projects over the [adoptable](#) highway, you will need to apply to us for a license under Section 177/178 of the [Highways Act](#) before we adopt your roads. If you do not apply for a license, we may not adopt your roads. Where a route runs alongside a road, its rear edge should normally coincide with the rear of visibility splays at junctions and on bends so the splay is clear and pedestrians and cyclists do not impede visibility. You should achieve this either by widening the footway or providing a verge. Grassed verges should be at least 1m wide and minimum area of 10sqm, otherwise you should use hard landscaping.

3.110 Routes that run separately from a road are not normally encouraged; for example, the [Manual for Streets](#) sets out that cyclists should generally be accommodated on the carriageway in residential areas. But where a separate route can be justified, for example, where it is necessary to break a road link to discourage through traffic or to give a more direct link to shops, schools, community facilities or public transport, you should take care to minimise crime opportunities. We will generally work with the relevant police force's Architectural Liaison Officer (ALO) to promote personal safety, and you should seek early advice from the FALO on proposals for specific sites. (Please see [paragraph 3.122](#) about [adopting](#) routes.)

3.111 As general guidance however, justified separate routes should normally meet the following criteria.

- They should be in the open wherever possible. Where this is not possible, buildings should be designed with windows overlooking the route. You should avoid blank walls or close-boarded fences and so on.
- Routes should be as short, straight and direct as is possible, ideally with each end being clearly visible from the other.
- Routes should be well lit.
- Within 2m either side of the route, any planting should be low, ground-cover only for at least 1m, grading to no more than 1m high. Plants should not have thorns. If a route is curved or has corners, you should increase the 2m distance to maintain satisfactory visibility.
- You should take care to make sure that any planting, particularly trees, would not reduce illumination from the lighting.

# The 6Cs Design Guide

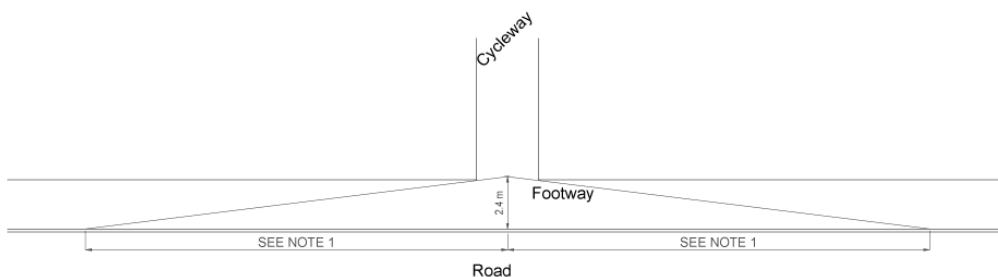

**Figure DG12** Examples of a poor pedestrian link (left) and a good pedestrian link (right)

3.112 Where a separate route joins another pedestrian or cycle route which runs alongside a carriageway (vehicle route), you should design its junction with the road network:

- so the route joins at 90 degrees to the traffic flow;
- to include barriers as in our [standard drawings](#) to prevent users, particularly children, from proceeding straight out into the road and also to stop use by vehicles; and
- to include visibility splays for cycle routes so that cycles emerging from the route can see and be seen. Visibility should normally be provided as indicated below.

**Figure DG13** Visibility splays at junctions for cyclists



NOTE 1: Length depends upon speed of vehicles on road.  
For distances, see table DG4

## Road crossings

3.113 The guidance on road crossings applies both to where pedestrians or cyclists are travelling:

- across a road; or
- along a road and they cross a side-road junction which includes any access more than a simple footway crossing.

3.114 In either case, appropriate crossing facilities will normally be required. You should agree requirements for specific sites with us in the early stages of preparing your development proposals.

## The 6Cs Design Guide

3.115 The normal basic requirement is to provide dropped kerbs with buff-coloured tactile paving as in our [standard drawings](#). Where a refuge in the middle of the road is required, you should provide this to standard drawings with:

- a 2m width for pedestrian-only use and 2.5m where it will be used by cyclists; and
- a 3.2m clearance to the carriageway edge on either side.

3.116 Please contact the relevant authority for cycling design advice.

3.117 In very large developments it may be necessary to consider some form of light-controlled crossing such as a Zebra, PELICAN or TOUCAN, to provide safe and attractive routes for pedestrians and cyclists.

3.118 Whatever the crossing type, if you need to provide guard railing to guide pedestrians or cyclists, it should be high-visibility railing as in our [standard drawings](#).

3.119 Where cyclists and visually-impaired pedestrians could potentially meet, you should provide surfacing to guide the visually-impaired users along the correct pedestrian route, in line with Department for Transport's '[Guidance on the use of Tactile Paving Surfaces](#)'.



### Signing for routes

3.120 Direction signing can help to highlight and promote the use of a route, although you should take care to minimise clutter and visual disruption. You should identify any requirements for specific sites and agree them with us in the early stages of preparing your development proposal. Any signing and lining you provide should be designed in line with the guidance in [Part 4](#) and our [best practice document](#).

### Materials and construction

3.121 Please refer to [Part 4](#).

### Adopting new routes

3.122 Where new footways and cycleways are located alongside roads that we are adopting, we will usually adopt them as publicly-maintained footways and cycleways as long as they have been constructed to our satisfaction.

3.123 We may also consider adopting other routes where they serve a strategic purpose, for example, where they form part of a wider network (existing or planned) or provide a more direct link to:

- major employment or a shopping centre;
- a school or other community or leisure facilities; or
- a bus stop or public transport;

providing that the routes have been constructed and lit to our satisfaction.



## The 6Cs Design Guide

3.124 [Part 5](#) provides details on procedures for adopting new routes under Section 38 agreements. [Part 6](#) covers works on the existing public highway under Section 278 agreements.

3.125 We will not normally adopt routes:

- that serve only private properties, public open spaces, play areas and so on;
- where there is already an existing satisfactory alternative adopted route; and
- where any adjacent routes they might link to are not adopted, or are of a poor standard.

3.126 You should discuss adoption issues with us in the early stages of preparing your development proposals.

### Existing rights of way

3.127 You cannot obstruct or divert an existing right of way without obtaining the [Rights of Way Authority's](#) consent (even if planning permission has been granted). You should accommodate an existing footpath on its existing right of way wherever possible. If, however, the Rights of Way Authority agrees in principle to a diversion, you will need a diversion order. The [planning authority](#) usually processes applications to divert rights of way using powers under the [Town and Country Planning Act 1990](#).

3.128 In all cases, the route of existing rights of way should normally be designed in line with the guidance set out in this document. You should take particular care to design bridleways to prevent their misuse by motor vehicles.

3.129 Where a development requires highway rights to be extinguished (removed), for example, to stop-up a length of road, this also should normally be done by the planning authority under the Town and Country Planning Act. You should get our agreement to your proposals to extinguish highway rights before you submit a planning application.

3.130 The procedures involved in making diversion orders or orders to extinguish existing highway rights can be very lengthy. You should get advice on the likely timescale and take this into account when you programme your proposals. Whether or not any order is successfully made, you will normally be responsible for paying all costs associated with processing it.

3.131 A guidance note for designers, developers and planners on Development and Public Rights of Way has been adopted by Derby City, Derbyshire County, Leicester City and Leicestershire County Councils. This guide can be viewed at [here](#). For guidance about Rights of Way in Nottingham City Council and Nottinghamshire County Council please contact the relevant authority ([see Appendix A](#)) for contact details.

### The existing and planned cycle route network

3.132 We are working along with organisations such as Sustrans and other highway authorities to provide a safe and convenient cycle network throughout our areas. Where a site stands close to this network, you will normally be expected to provide links to it as part of your proposals. You will also be expected to contribute towards its completion where it is reasonable to ask you to do so.

# The 6Cs Design Guide

## Providing cycle parking and other facilities for cyclists

3.133 Please see [Section DG16](#).

### Section DG8: Horse riders

3.134 Horse riders are entitled to use bridleways, all-purpose roads and byways open to all traffic. You should consider them in the design and safety audit of all developments which either:

- affect an existing or future bridleway; or
- affect an existing or future all-purpose road that carries horse riders.

3.135 The guidance in this section relates generally to lower-speed single carriageway roads. For facilities for horse riders in other circumstances, please refer to [TA57/87 Roadside Features](#), section 11.

3.136 Bridleways carry horse riders, cyclists and pedestrians, and you should take the needs of all these groups into account.

3.137 For horses, a blinded crushed stone surface is often best, being hard wearing without being as hard on hooves as asphalt.

3.138 Where a new junction is formed between a bridleway and a road, a Pegasus crossing facility should be provided. In addition, a bridleway sign should be erected.

3.139 New roads likely to carry significant horse traffic (more than 100 passages a week) may need verges suitably surfaced for horses. For particularly well-used routes, for example, near a riding school, you should consider providing a separate horse trackway beyond the verge, possibly separated from vehicles by fencing or a hedge.



### Section DG9: Lining, signing and traffic regulation orders

3.140 You will normally be required to provide all road markings and traffic signs both on the internal development roads and on the surrounding road network where necessary. Occasionally, this may involve signing at some distance from the development, for example, for routing HGVs.

3.141 At your developments' site access, lining and signing should be provided in accordance with [Traffic Signs Regulations and General Directions 2002](#) (TSRGD). For priority junctions within developments, junction lining and signing:

- will not normally be required in residential developments;

## The 6Cs Design Guide

- will not normally be required in B1 use class office developments; but
- will be required in all other employment and commercial developments, provided in accordance with TSRGD.

Other types of development will be considered on a site-by-site basis.

3.142 In addition to markings at junctions as indicated above, carriageway centre-line markings will:

- not normally be required in residential developments;
- will not normally be required in B1 use class office developments; but
- will be required in all other employment and commercial developments, provided in accordance with TSRGD.

Other types of development will be considered on a site-by-site basis.

3.143 Signing and lining, in accordance with TSRGD, should also be provided at all road humps/tables, at any entry ramps to side roads and at any other traffic calming features. Where parking bays are not clearly defined, markings will be required to segregate them from the carriageway.

3.144 Wherever signing and road markings are required, you should normally provide them in line with the requirements set out in [Part 4, Section MC12](#), including the need for illumination. You should establish at an early stage in the detailed design process which signs will require illumination to make sure that appropriate electrical supplies are installed during construction work.

3.145 Where a development requires changes to an existing traffic regulation order (TRO) or a new order is required, you will normally be required to pay all costs associated with this, including all consultation and legal costs. TROs are subject to statutory [procedures and consultations](#). This can be a very lengthy process and a successful outcome is not guaranteed. You should get advice on the likely timescale and take this into account when you programme your proposals.

### Section DG10: Street lighting

3.146 We normally require a suitable system of street lighting on all [adoptable roads](#), which we will normally design for you in areas to be adopted. This is important for both road safety and to help promote personal safety and minimise crime opportunities. It is also important that you plan the lighting at the same time as you design the street layout. Also, to encourage pedestrians to use a route and to feel safe, it is important that lighting levels are maintained at the same standard along a route, whether a route is adopted or not. There are also wider design issues. When you prepare development proposals, you should consider the purpose of the lighting, its scale and the proposed width of the street and height of the building.

3.147 For more details on lighting, please see [Part 4](#).

# The 6Cs Design Guide

## Section DG11: Utility equipment (for example, gas, water, cable TV)

Note: Our [standard conditions](#) applying to highway works for new development provide more advice on dealing with utility equipment during construction of your works.

3.148 Early in your planning process you should consider the location and installation of utility equipment both above and below ground, particularly where surface areas are shared. Normally, private equipment should not be located in the highway\* but utility company's equipment should be. Where a shared-surface layout is proposed without a separate service margin or where a development layout is not explicitly covered by this guidance, you should hold early discussions with [utility providers](#) and supply us with details of proposed locations for utility equipment. This will enable us to consider the layout, for example, in terms of safety and accessibility.

\*This can be difficult to achieve with layouts where houses are located very close to the highway boundary. However, if you do not deal with this matter, it may lead to problems in future with us [adopting](#) your road.

3.149 Any separate service margin should be at least 2m wide, in line with [National Joint Utilities Group \(NJUG\) 7](#). And any utility equipment that is above ground, for example, cabinets, boxes, pillars and pedestals should be sited so that it:

- does not constitute a danger to the public or to staff working on it;
- does not obstruct a drivers' view, for example, by siting it in visibility splays;
- does not obstruct pedestrians, wheelchairs, prams, pushchairs and so on. You should provide at least 1.2m clearance increased to 2m in areas of high pedestrian flows (500 pedestrians an hour);
- is not located within 5m of any other street furniture that would create a double obstruction to pedestrians. Any item within 5m must be in line;
- does not provide a means of illegal access to adjacent premises or property, for example, you should avoid sites alongside a high wall so the equipment cannot be used to climb over the wall;
- does not offend visual amenity (spoil the view) by restricting the outlook from the window of a house, intruding into areas of open-plan front gardens or disrupting the line of low boundary walls;
- does not spoil the view of a Grade I or Grade II listed building; or
- does not result in 'visual clutter' by being in an inappropriate place.

3.150 All apparatus above the ground should:

- be positioned so there is enough access for the equipment and the surrounding highway to be maintained and cleaned;
- not be located within any tactile paving (in the case of surface covers);
- allow space for associated jointing chambers;
- take account of known highway alterations;
- allow for future surfacing work, for example, by using raised plinths and allowing for spare cable if the boxes are raised in future; and
- meet the license requirements for listed buildings and conservation areas. You need to give special consideration to cabinet design in conservation areas.

## The 6Cs Design Guide

3.151 Where equipment is to be located in a proposed [adoptable](#) highway, you should locate cabinets and so on in the verge where possible. You should leave at least 1m between the cabinet and the edge of the carriageway in rural areas and 1.5m in urban areas. Access doors should always open to the footway. If there is no verge, you must position cabinets and so on at the back of footway and keep:

- a minimum distance of 1m between the edge of an open access door and the edge of the carriageway where pedestrian flows are low; or
- a minimum distance of 2m between the edge of an open access door and the edge of the carriageway where pedestrian flows are heavy (500 pedestrians an hour at any time).

3.152 We may consider adopting any additional small areas so above-ground apparatus can meet locational requirements. If, however, you cannot meet the requirements within adoptable areas, you should locate cabinets and so on off the proposed adoptable highway. You may need an easement to allow utility equipment providers access in future for maintenance purposes.

3.153 You should locate equipment below ground in line with NGU7. You should locate any access chambers that are on the surface to:

- minimise disruption to pedestrians and provide adequate access for installing and maintaining equipment, and recovery operations;
- avoid expensive paving as far as possible, for example, tactile paving;
- avoid other utility providers' equipment;
- allow for using mechanical equipment during construction and installation, maintenance and recovery operations at the site;
- take into account any known highway alterations;
- make sure the type and construction of underground boxes allows us to raise covers and frames when we carry out resurfacing work; and
- avoid potential archaeological features, including foundations to listed buildings.

# The 6Cs Design Guide

**Figure DG14 Arrangement of below ground service equipment**

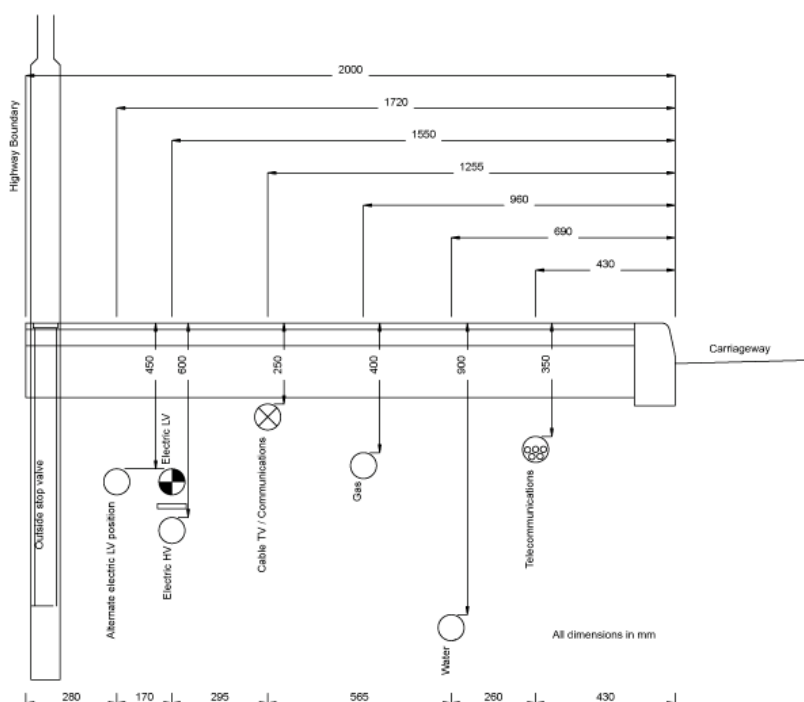

3.154 Where developments include central recycling points, you should site these also in line with the above guidance.

## Section DG12: Drainage

3.155 We have a duty to make sure that developments include satisfactory arrangements for draining the [adoptable highway](#). This should normally be achieved by one of the following methods.

- All highway water should be drained direct into a piped system adopted by a water company. Please see [Part 7](#) for contact details. This is the method we prefer.
- If the above method is not possible, water should be drained by a piped highway drainage system (minimum pipe size 225mm) running to an out-fall adopted by a water company or an out-fall to a ditch or watercourse agreed by the [Environment Agency](#). We will normally adopt a piped highway-drainage system like this where we are adopting the road.

All highway drains should be located within land that we are adopting. Only in exceptional circumstances will we permit them in land that is to remain private. You must cover any adoptable highway drain outside the limits of the adoptable highway by an easement agreement. This should be in place before, or be a condition of, the Section 38 or 278 agreement.

3.156 We will consider alternative highway-drainage systems, including SUDS, flow attenuation (reduction) or retention systems (including oversized pipes) and so on, on a site-by-site basis. Where there are valid reasons for providing systems like these, and where they would present us with extra maintenance liability over a piped system, we will

# The 6Cs Design Guide

require you to pay [commuted sums](#). Please see [Part 4, Section MC18](#) for further details on our commuted sums policy.

3.157 We will not adopt a road unless its associated drainage is to be adopted either by a water company or by us.

3.158 We will not normally accept drainage of other non-adopted areas into any highway system. In general, the drainage of most other areas of a development are matters for water companies. You should normally design these drainage systems in line with the water companies' specifications and requirements (which you may treat as complementary to this document) and they should be adopted by them.

3.159 Please refer to [Part 4 Section MC8](#) for more details on highway drainage design and to [Part 4 Section MC18](#) for more details on commuted sums.



## Section DG13: Landscaping

3.160 Soft or hard landscaping within highway areas can be as important in determining the character of the development and integrating it into its surroundings as landscaping elsewhere within the site. You should not underestimate how important it is to create an attractive environment. Planning authorities are unlikely to favour developments that lack quality design and layout.

3.161 Areas we are prepared to [adopt](#) as highway should be concentrated into larger areas, to provide economies of scale and to avoid small or remote areas which are difficult to maintain. Small and remote areas can actually result in the very opposite of what is intended of creating an attractive and well-cared-for environment.

3.162 You should prepare landscaping proposals at the pre-planning application stage so we can consider their suitability in good time and so the utility providers (for example, gas, water, cable TV) can be consulted over the proposals. We must approve the landscaping proposals within the development whether or not they form part of a landscaping scheme that you have submitted to the planning authority for approval. (Please see [Part 4](#) for further information).

3.163 While planting and trees can enhance the street scene, you must take care when you are selecting and positioning trees, shrubs and so on to make sure that building frontages and parking areas can still enjoy good natural observation from areas of potential activity such as roads and footways. Where trees outside of the highway boundary are planted within close vicinity of the highway boundary, root deflectors or root protection barriers may need to be considered.

3.164 We will require the payment of a [commuted sum](#) for any proposed planting, trees, shrubs and so on that we are prepared to [adopt](#). Please see [Part 4, Section MC18](#) for further details on our commuted sums policy.

## The 6Cs Design Guide

3.165 Public open spaces, including amenity open spaces and children's play areas, will normally be adopted by the district, town or parish council. We will normally only consider adopting an area of open space that:

- is next to but not essential part of the adoptable highway;
- is not going to be adopted as public open space by the district, borough or parish council;
- cannot be designed out; and
- may not be safely and satisfactorily maintained if it becomes part of the adjacent property.

You will need to pay us a [commuted sum](#) for any open space we adopt.



### Section DG14: Vehicle parking and making provision for service vehicles

- [Off-street parking standards](#)
- [Disabled parking](#)
- [Standards for servicing provision](#)
- [General design principles for off-street parking](#)
- [On-street parking](#)

3.166 This section sets out off-street parking standards and gives guidance on the design of parking in residential and employment and commercial developments. It covers vehicle parking, provision for service vehicles, motorcycle parking and cycle parking.

3.167 We will be considering parking standards further with District, Borough and City Councils as they prepare their development plans. In particular:

- in urban areas we will be seeking to identify more specific areas where the various parking standards will normally be applied; and
- we will be considering appropriate standards for rural areas.

We will review the standards in the light of any further national guidance or research. The Chartered Institution of Highways and Transportation (CIHT) and the Institute of Highway Engineers (IHE) have published (April 2012) a guidance note on residential parking. This can be viewed [here](#). In the meantime, the normal starting point for determining off-street parking provision is set out in the following paragraphs and tables. Where you are in doubt about which type of area a development falls into, you should discuss this with us and the planning authority at the earliest opportunity.



## The 6Cs Design Guide

3.168 Parking provision should be considered in relation to any transport assessment and travel plan associated with a development proposal. Please refer to [Section DG17](#).

3.169 Where you do not provide suitable parking arrangements within a development, we may refuse to [adopt](#) the development roads.

### Off-street parking standards (excluding residential see [3.168](#))

3.170 The normal maximum vehicular parking standards shown in Table DG11 below are taken from [RPG8](#). For developments below the threshold, we will continue to apply the standards contained in the previous guidance document [Highway Requirements for Development \(HRfD\)](#) for the time being as the normal maximum standards. In certain circumstances, for example, where there are road safety or amenity issues that cannot be satisfactorily resolved, we may require a higher level of parking provision.

**Note:** These standards will normally be applied in areas for which Leicestershire County Council is the highway authority. Other authorities have their own separate standards which will normally be allied for developments.

Leicester City Parking standards can be found at [www.leicester.gov.uk](http://www.leicester.gov.uk)

Nottinghamshire County Council parking standards can be found at [www.nottinghamshire.gov.uk/travelling/parking/parkingpolicy/](http://www.nottinghamshire.gov.uk/travelling/parking/parkingpolicy/)

**Table DG11: Normal maximum parking standards** <sup>(a)</sup> <sup>(b)</sup>

Use <sup>(c)</sup>	Normal maximum parking standard based on one space for every square Metre (m <sup>2</sup> ) of gross floorspace unless otherwise stated	Threshold for applying the standard (gross floorspace) <sup>(d)</sup>
Food retail	One space for every 14m <sup>2</sup>	1000m <sup>2</sup>
Non food retail	One space for every 20m <sup>2</sup>	1000m <sup>2</sup>
B1 offices	(see note e) Urban town centre or edge of centre; One space for every 60m <sup>2</sup> Rural town centre or edge of centre; One space for every 40m <sup>2</sup> Rest of rural town; One space for every 30m <sup>2</sup> Out of any town; One space for every 30m <sup>2</sup>	2500m <sup>2</sup>
B1 Non-office and B2 General industry <sup>(f)</sup>	(see note e) Urban town centre or edge of centre; One space for every 130m <sup>2</sup> Rest of urban town; One space for every 80m <sup>2</sup>	2500m <sup>2</sup>

## The 6Cs Design Guide

	<p>Rural town centre or edge of centre; One space for every 90m<sup>2</sup></p> <p>Rest of rural town; One space for every 65m<sup>2</sup></p> <p>Out of any town; One space for every 55m<sup>2</sup></p>	
B8 Warehousing	<p><a href="#">(see note e)</a></p> <p>Urban town centre or edge of centre; One space for every 300m<sup>2</sup></p> <p>Rest of urban town; One space for every 180m<sup>2</sup></p> <p>Rural town centre/edge of centre; One space for every 200m<sup>2</sup></p> <p>Rest of rural town; One space for every 150m<sup>2</sup></p> <p>Out of any town; One space for every 120m<sup>2</sup></p>	2500m <sup>2</sup>
Cinemas and conference facilities	One space for every five seats	1000m <sup>2</sup>
D2 (other than cinemas, conference facilities and stadia)	One space for every 22m <sup>2</sup>	1000m <sup>2</sup>
<a href="#">Higher and further education</a>	One space for every two staff plus one space for every 15 students <sup>(g)</sup>	2500m <sup>2</sup>
Stadia	One space for every 15 seats <sup>(h)</sup>	1500 seats

(a) You should provide parking for people with disabilities as in [paragraph 3.177](#) onwards.

(b) Please refer to [paragraph 3.181](#) onwards for details on sizes of parking spaces and the design of car-park layouts.

(c) Please see [paragraph 3.171](#) onwards for standards for residential parking.

(d) Please see [paragraph 3.170](#) for developments below the thresholds shown or otherwise not listed.

(e) [RPG8](#) defines Leicestershire urban towns as Oadby, Wigston, Hinckley, Earl Shilton, Barwell, Burbage, Loughborough and Shepshed. We will work with district councils to establish where within and around these towns the various levels of parking standards will specifically apply. It will also work with the district councils to agree standards for rural towns, which are not defined in RPG8.

(f) We will recommend that restrictions are imposed to prevent changes to B1 office use where no allowance has been made for the higher parking levels associated with offices.

# The 6Cs Design Guide

(g) The figure for students relates to the total number of students rather than full-time equivalent figures.

(h) You should provide parking spaces for coaches in addition to the above, to be agreed for each specific site. Coach parking should be designed and managed so that it will not be used for car parking.

3.171 In Leicestershire, where no parking standard is given for a particular development (either in [Table DG11](#) or in our [previous document HRfD](#) or in [paragraph 3.174](#) for residential developments), we will consider the provision required taking certain factors into account including:

- the control of on-street parking in the area;
- the development's exact nature and likely use;
- its geographical location;
- the standard of the surrounding road network and the traffic and parking conditions on it; and
- how accessible the development is using other methods of transport, including public transport, walking or cycling.

Note: Leicester City Council and Nottinghamshire County Council have their own [separate standards](#) which it will normally apply to developments in their areas where Leicestershire County Council is the highway authority.

3.172 The Department for Communities and Local Government (DCLG) has recently published a [research paper on residential car parking](#) (Appendix M). It sets out a method for calculating total demand for parking for a proposed housing development based on a number of factors including:

- car ownership levels;
- size and type of housing (that is owner-occupied, rented and so on); and
- whether the parking spaces are to be allocated to particular houses or unallocated.

Depending on the scale of your proposed development, we will normally expect you to apply this method.

**3.173 Developments of 1 to 5 houses:** You have the choice of either applying the following standards or using the DCLG paper method referred to in paragraph 3.168. (Please see [paragraph 3.174](#) if you intend to use the DCLG method.)

- One space for each dwelling:
  - where car ownership may be low, such as town centres and other locations where services can easily be reached by walking, cycling or public transport.
- Two spaces for each dwelling:
  - urban locations with poor access to services and poor public transport services;
  - three-bedroom dwellings in suburban or rural areas; and
  - other locations where car ownership is likely to be higher than locations that are better served by public transport.
- Three spaces for each dwelling:
  - four-bedroom dwellings in suburban or rural areas; or

## The 6Cs Design Guide

- other locations where car ownership is likely to be higher than locations that are better served by public transport.

3.174 **Developments over 5 dwellings:** We will normally expect you to apply the DCLG paper method.

3.175 Where you are using the DCLG paper method, we will normally expect you to provide your initial estimate of parking demand before you submit a planning application. We will also expect you to supply details of how that demand will be met, that is the mix of on-plot parking\*, on-street parking and parking courts\*\*. When you calculate parking demand, you should remember that the counties are both geographically and economically diverse, which can influence levels of car-ownership. They range from rural areas to the more densely-developed suburbs.

Notes:

\*We will normally only consider counting garages as parking spaces where they meet the dimension requirements set out in paragraph 3.221.

\*\*Experience with recent developments is that many residents make little or no use of parking courts. This results in wasteful use of land as well as on-street parking which the road layout has not been designed to accommodate. Where you are proposing a development that includes communal parking courts\*, we would only consider a lower level of parking provision on the site where:

- parking courts are designed to take account of the principles set out in [paragraph 3.182](#); and
- there would be no conflicts with the objectives of our '[highways development control policy](#)'

*(\*Note: A communal court is a parking area available for general use by residents and visitors in, for example, a development of flats. This guidance does not apply to a parking court allocated to an individual property or allocated parking spaces grouped together to serve several properties, such as rear parking courts that are becoming increasingly common in new developments.)*

# The 6Cs Design Guide

**Figure DG15a** May be prepared to consider a lower level parking provision

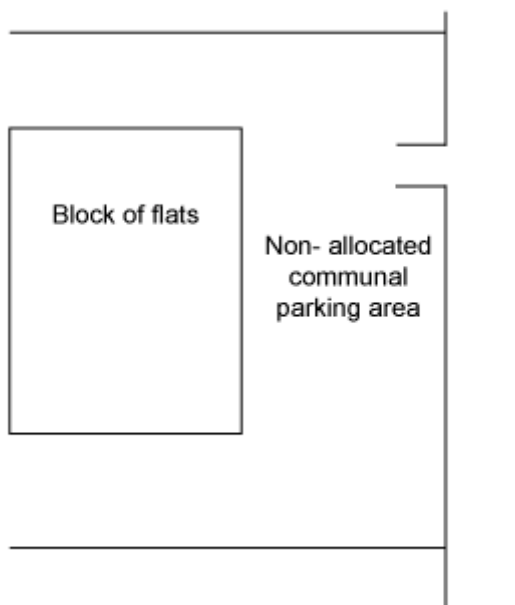

**Figure DG15b** Reduced parking provision would not normally be considered

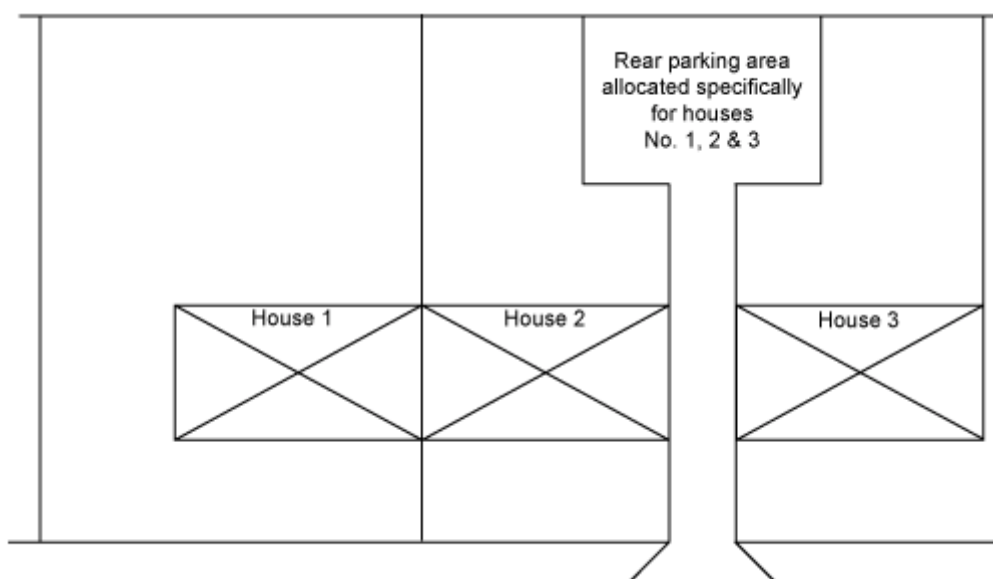

3.176 For details of garage design and layout please refer to [Section DG18, paragraph 3.222](#) onwards. Garages will not normally be counted as a parking space for the purpose of calculating parking provision, unless:

- the garage meets the minimum dimensions given in [Section DG18](#);
- planning conditions are imposed to control use of the garage; or
- restrictions are placed on converting the garage to a room that can be lived in.

If a dwelling has no separate [parking for cycles](#), it may affect whether we consider that the garage should be counted towards parking provision.

## The 6Cs Design Guide

3.177 Where satisfactory levels of off-street parking are not provided, measures may be required in line with [paragraph 3.192](#) onwards to minimise the risk of problems caused by on-street parking, including providing wider roads.

### Disabled parking

3.178 Many disabled people rely on the car for getting about. Whether they drive themselves or travel as a passenger, reaching their destination with ease is almost always determined by where the car can be parked. So it is very important that proper parking provision is made in new developments.

3.179 For all non-residential developments, you should provide disabled parking to the minimum standards shown in Table DG12. This provision should be in addition to general parking provision. Parking for disabled people should be located as close as possible to the main entrance of a building.

**Table DG12: Minimum provision for disabled parking spaces <sup>(a)</sup>**

Car park used for	Car park size	
	Up to 200 spaces	Over 200 spaces
Employees and visitors to business premises	Individual bays for each disabled employee plus two bays or 5% of total parking spaces whichever is greater	Six bays plus 2% of total parking spaces
Shopping, recreation and leisure	Three bays or 6% of total parking spaces whichever is greater	Four bays plus 4% of total parking spaces
Schools and higher and further education	At least one bay regardless of car park size	At least one bay regardless of car park size

(a) Please refer to [paragraph 3.181](#) onwards for details on sizes of parking spaces and design of car park layouts.

3.180 You should monitor how reserved bays are used to make sure:

- other motorists do not abuse their use; and
- the number of spaces continues to meet the full demand.

# The 6Cs Design Guide

## Standards for servicing provision

3.181 Servicing provision for various types of development are given in [Table DG13](#).

**Table DG13: Minimum servicing provision <sup>(a)</sup>**

Use class	Description of land use	Normal servicing provision
A1	Shops	Stores above 5000m <sup>2</sup> One goods bay space for every 1000m <sup>2</sup> ; Stores between 3000m <sup>2</sup> to 5000m <sup>2</sup> One goods bay space for every 750m <sup>2</sup> ; Stores between 300m <sup>2</sup> to 3000m <sup>2</sup> You must make provision within the site for service and delivery vehicles to be loaded and unloaded clear of the highway.
A3, A4	Restaurants, cafes and drinking establishments	You must make provision within the site for service and delivery vehicles to be loaded and unloaded clear of the highway.
B1	Light industry, Research and development	One lorry space for every 500m <sup>2</sup>
B2	General industrial	One lorry space for every 400m <sup>2</sup>
B8	Storage and distribution	One lorry space for every 400m <sup>2</sup>

(a) Please refer to [paragraph 3.181](#) onwards for details on sizes of parking spaces and design of car-park layouts.

## General design principles for off-street parking

3.182 **Residential:** Off-street parking areas should be close to the dwellings that they serve to make sure that they are fully used. This will minimise the possibility of on-street parking problems. Separate parking areas which are remote from some or all of the properties that they serve, and which cannot be easily observed, can result in on-street parking problems and also crime, anti-social behaviour and maintenance problems which discourage their use and affects the overall quality and appearance of a development.

3.183 You should involve us, the planning authority and the relevant police force Architectural Liaison Officer (ALO) in finding parking solutions. But, as general guidance to avoid potential problems, remote parking areas should normally:

- be located near to the main entrances to the properties that it serves, with as short and direct a walking route as is possible between the parking court and the property;
- be secure, including enjoying good natural observation from neighbouring buildings and not be surrounded by blank walls or close-boarded fences and so on;
- be well lit;
- limit planting to low ground cover only;

# The 6Cs Design Guide

- be suitably surfaced and drained, and you will be expected to provide clear details of future maintenance responsibilities (we will not normally [adopt](#) off-street parking areas);
- have clearly-designated spaces for individual dwellings; and
- have open pedestrian routes to the parking area where possible. Where not, they should be designed in line with the guidance on separate routes at [paragraphs 3.111](#) onwards of this document.

The location and overall design should encourage maximum use of the parking areas in order to minimise the risk of on-street parking problems.

3.184 You should consider the needs of people with mobility and visual impairments both in the layout of the parking area and any routes between it and the associated dwellings.

**3.185 Industrial and commercial and other large-use car parks (for example for leisure and retail):** We will not normally [adopt](#) off-street parking areas in these developments. However, your design should do the following.

- Make sure there is free flow of traffic entering and leaving the car park to minimise the likelihood of tailbacks causing safety problems and delays on the surrounding road network. This may require one-way systems with control ramps or flaps at entrances and exits and appropriate signing in larger car parks.
- Provide safe pedestrian and cycle routes across the car park to building entrances, following natural paths wherever possible. In larger car parks you should consider segregated routes with raised crossing points on main vehicle routes. Any routes should be in the open wherever possible. Where not, you should design them in line with the guidance on separate routes at [paragraphs 3.111](#) onwards of this document.

3.186 You should also design such off-street parking areas to:

- minimise the number of entry and exit points to the public highway;
- provide visibility splays appropriate to likely vehicle speeds and 'road' widths and corner radii appropriate to likely vehicle sizes and manoeuvres;
- be well lit;
- be well landscaped, although any planting should be kept to low ground cover only;
- be suitably surfaced and drained;
- take into account and complement relevant measures included in any travel plan associated with the development, for example, car-share spaces located closest to the building entrance; and
- make appropriate provision for those with mobility and visual impairments in line with [Traffic Advisory Leaflet 5/95](#). This includes locating parking spaces in larger car parks as follows:

Disability	Distance (metres)
Visually impaired	150
Wheelchair users	150
Ambulatory without walking aid	100
Stick users	50



## The 6Cs Design Guide

3.187 For more information about designing and locating disabled parking spaces, please consult [Traffic Advisory Leaflet 5/95](#) Parking for Disabled and [Building Regulations Part M \(2004 Edition\)](#), particularly with regard to the design of any payment or ticket machines or car park access-control systems.

3.188 Minimum parking space sizes and aisle widths are shown in Figure DG16.

### **Figure DG16 Size and layout of parking spaces.**

*Minimum parking spaces 2.4m x 5.5m add 0.5m if bounded by a wall, fence, hedge, line of trees or other similar obstruction on 1 side, 1m if bounded on both sides.*

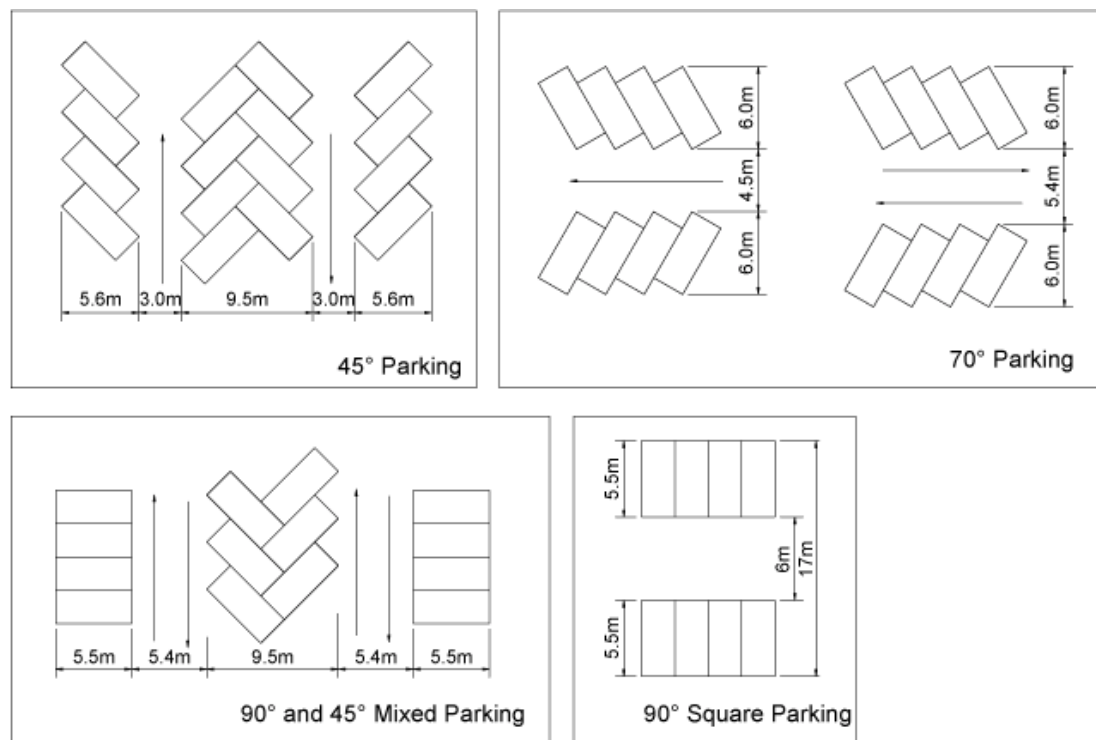

Examples of typical parking layouts

# The 6Cs Design Guide

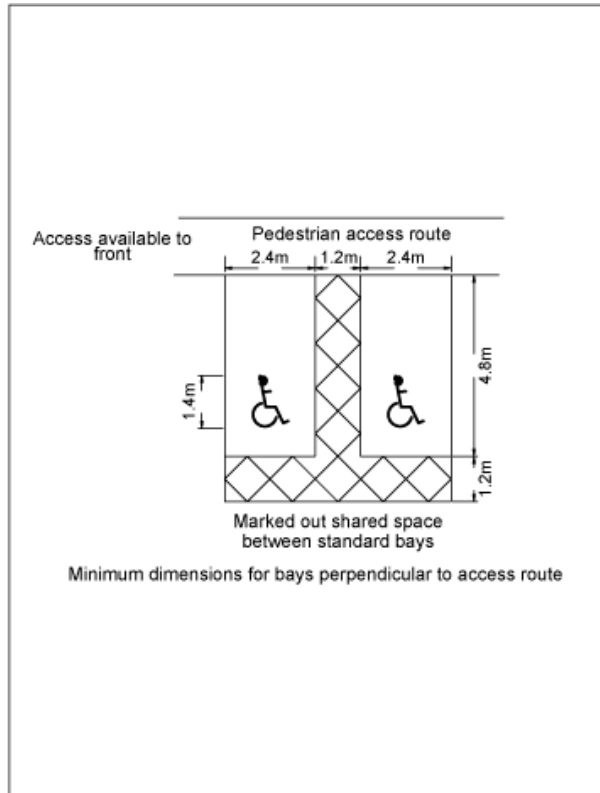
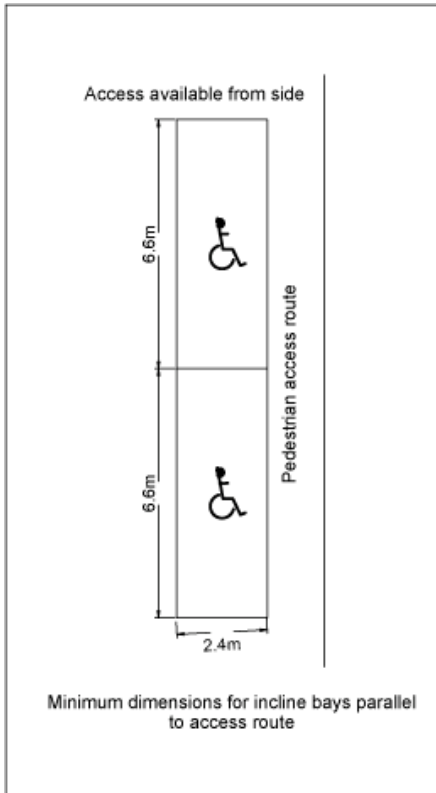

Disabled parking spaces layout

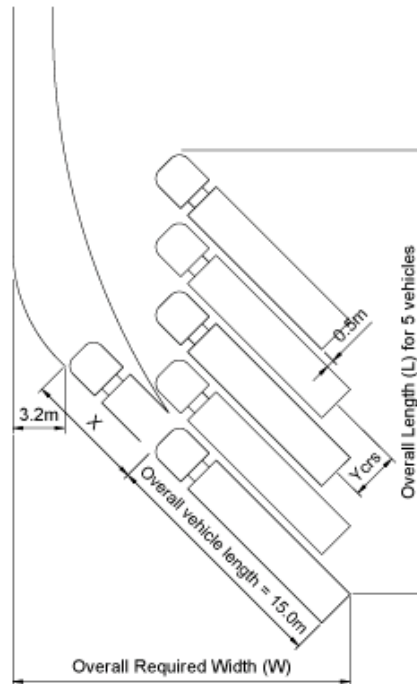
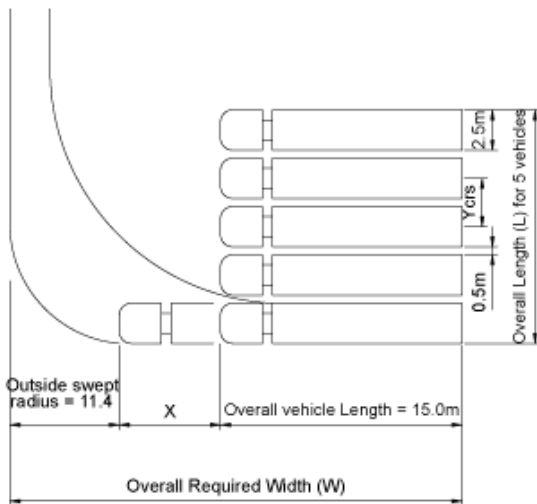

Notes:  
X = Draw forward before turning distance

**Lorry parking and loading bays - head-on and Lorry parking and loading bays - 45° for largest vehicles**

## The 6Cs Design Guide

X draw forward	Y centres	W o/a width	L o/a length for 5	X draw forward	Y centres	W o/a width	L o/a length for 5
1	5.0	27.4	22.5	4	4.8	18.4	39.5
2	4.4	28.4	20.1	5	4.5	19.1	37.8
3	4.0	29.4	18.5	6	4.2	19.8	36.1
4	3.7	30.4	17.3	7	3.9	20.5	34.4
5	3.4	31.4	16.1	8	3.6	21.2	32.7
6	3.0	32.4	14.5	9	3.4	21.9	31.6
				10	3.2	22.6	30.5
				11	3.1	23.4	29.9
				12	3.0	24.1	29.3

### On-street parking

3.189 Research we have carried out has shown that a main concern of Leicestershire residents is on-street parking. National research, including that by the New Homes Marketing Board and Halifax PLC, also highlights on-street parking as a real problem. Where on-street parking provision is poorly designed, it can:

- impair road safety
- obstruct access for vehicles, including for service vehicles, the emergency services and buses;
- obstruct footways and be a hazard to cyclists and pedestrians, including those with mobility or visual impairments;
- make a development look cluttered and unattractive;
- be a source of crime; and
- cause friction between occupiers where private accesses are blocked.

### Figure DG17 Examples of on-street parking problems



Parking in turning head and obstructing access to private drives

'Unsightly' parking obstructing a junction

## The 6Cs Design Guide



Parking obstructing a footway - hazard to pedestrians

Access for service vehicle restricted by parking



Parking causing vehicles to cross on to wrong side of the road

3.190 So, in the interests of the safety of all road users, including pedestrians and cyclists, and of maintaining efficient flow of traffic, we will look for developments that include well-designed parking layouts (on-street and off-street) that minimise the likelihood of on-street parking problems. For parallel parking to a road, each vehicle will normally need an area of about 2m wide x 6m long. For echelon (wedge shaped) parking and perpendicular (end on to the road) parking, individual bays should normally be indicated or marked. Bays should normally be about 2.4m wide and a minimum 4.8m long and they should be arranged so that drivers are encouraged to reverse into them. Figure DG18a shows some suggested on-street parking arrangements, and also sets- out how to calculate the necessary width needed to access echelon parking. A guidance note on residential parking, produced by the Chartered Institution of Highways & Transportation (CIHT) and Institute of Highway Engineers (IHE), can be viewed at: <http://www.ciht.org.uk/en/publications/standards--advice.cfm>.

3.191 Where it appears that on-street parking could cause problems, we will ask you for computerised tracking assessments of appropriate vehicle paths (these are likely to include refuse lorries, pantechnicons, fire tenders and buses if the development is to be served by public transport). Where the assessment demonstrates that it is necessary to provide extra width to accommodate on-street parking, you should normally achieve this either by:

- providing parking bays as illustrated below (bays should not be designated to particular properties); or
- increasing the overall carriageway width. We can accept localised width variations - it is not necessary for a road to have a constant width and parallel kerb lines throughout.

# The 6Cs Design Guide

**Figure DG18 Good examples of on-street parking bays**



**Figure DG18a Suggested on-street parking bays, parallel and perpendicular parking (top) and widening of carriageway to create on-street spaces (bottom).** This Figure is based upon Figures 8.18 and 8.19 and paragraph 8.3.5.1 of the Manual for Streets documents. The Manual for Streets is copyright of the Department for Transport and Department of Communities and Local Government

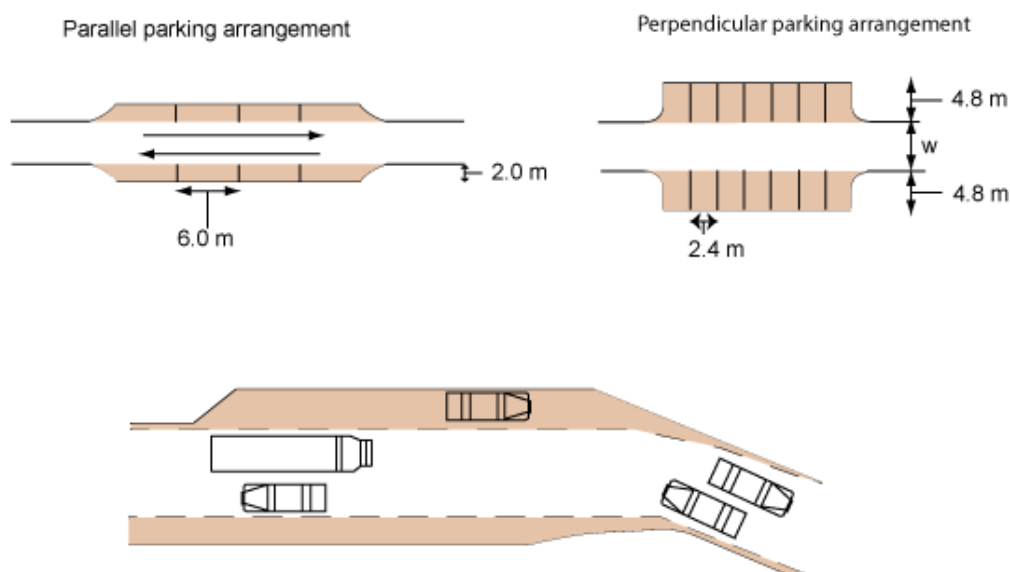

3.192 Where we [adopt](#) additional areas to accommodate on-street parking, you will have to pay [commuted sums](#) to cover future maintenance. Please see [Part 4, Section MC18](#) for further details on our commuted sums policy.

3.193 You may also be required to provide measures to prevent parking in unsuitable areas and to make sure parking bays are used correctly. This might include providing bollards, fencing and landscaping. These should be integrated with the design of the overall development proposal and may also require the payment of [commuted sums](#) to cover their future maintenance. You may also need to adjust proposed building and plot layouts to

## The 6Cs Design Guide

avoid locating pedestrian accesses at points where they may cause problems if someone left their vehicle parked on-street while in the building.

3.194 In certain circumstances, traffic regulation orders may be needed to control on-street parking, including waiting restrictions and residents' parking schemes either within the development or on the surrounding highway network. Where this is so, you will normally be required to pay all costs associated with making the orders. (Please also see [Section DG9](#).)



### Section DG15: Parking for motor cycles

3.195 Motorcycles and mopeds can provide an alternative to the private car for certain trips. There is a growth in the popularity of motorcycles and mopeds both for leisure and as a means of transport where public transport is limited and walking or cycling is unrealistic. If people switched from walking, cycling and public transport to riding motorcycles and mopeds, the environmental benefits would be less clear.

3.196 The parking standard for motorcycles and mopeds is:

- one space, plus an additional space for every 10 car parking spaces.

3.197 Parking spaces should normally be:

- 2.5m x 1.5m with a 1m space between each bike.

3.198 The design of the parking area should allow motor cycles and mopeds to be secured to the ground while parked.

3.199 Parking provision should be considered in relation to any travel plan associated with a development proposal. Please refer to [Section DG17](#).



### Section DG16: Parking for cycles

3.200 As the [Manual for Streets](#) emphasizes, providing well-located, safe and secure cycle parking is a major factor in encouraging people to cycle as an alternative to using the

## The 6Cs Design Guide

private car. So, the parking standards in Table DG14 below are the normal minimum requirements.

Note: Leicester City's parking standards can be found at [www.leicester.gov.uk/your-council-services/ep/planning/plansandpolicy/localplan/writtenstatement/appendicescllp](http://www.leicester.gov.uk/your-council-services/ep/planning/plansandpolicy/localplan/writtenstatement/appendicescllp)

3.201 Where it is not possible to provide cycle parking spaces on site, you will normally be expected to make a financial contribution towards providing public facilities where this provision is possible.

**Table DG14: Minimum provision for cycle parking <sup>(a)</sup>**

Use class	Description of land use	Provision
A1 and A3	Shops and restaurants, pubs and clubs	One space per 500m <sup>2</sup> up to 4000m <sup>2</sup> gross floor area (GFA) for staff and operational use. Parking to be secure and under cover. One space for every 1000m <sup>2</sup> GFA for customer use to be in the form as shown in <a href="#">Figure DG19</a> . Parking to be located in a prominent and convenient location.
A2 and B1	Financial and professional services, and research and development and offices	One space per 400m <sup>2</sup> GFA for staff and operational use. Parking to be secure and under cover. Customer parking to be assessed on a site-by-site basis.
B2 to B8	General industry and storage and distribution	One space per 400m <sup>2</sup> GFA. Parking to be secure and under cover.
C3	Dwelling houses <sup>(b)</sup> <sup>(c)</sup>	For developments with common facilities, such as flats, one space for every five dwellings. Parking to be under cover and secure. Where spaces are allocated, there should be one space for each dwelling.
D1 and D2	Non-residential institutions, assembly and leisure	Staff parking to be assessed on a site-by-site basis. Sufficient cycle racks to accommodate five percent of the maximum number of visitors expected to use the facility at any one time. Racks to be in the form as shown in <a href="#">Figure DG19</a> and to be located in a prominent and convenient location.

(a) Developments or circumstances not covered in the table will be assessed on a site-by-site basis.

(b) If cycle parking is not provided for residential developments, it may affect the way we consider the use of garages, i.e. whether they should count towards parking provision.

(c) If cycle parking is provided on upper floors, such as in flats, lifts that can take bikes should be provided.

3.202 All cycle parking must:

- be secure and normally with weather protection;
- be conveniently located at entrances to buildings;
- enjoy good natural observation;

## The 6Cs Design Guide

- be well lit; and
- be located so it does not obstruct pedestrian and cycle routes.

3.203 Normally you should provide Sheffield stands as illustrated in Figure DG19 below. Stands that grip only the front wheel do not provide adequate support or security. When placed 1m apart and 0.5m from the wall, Sheffield stands can accommodate two bicycles. Where more than two stands are required, you may need to provide a 'toast rack' facility.

**Figure DG19 Sheffield stand - inset 'toast rack' type. Sheffield stands can accommodate two cycles provided that stands are placed 1m apart and at least 500mm from any wall.**

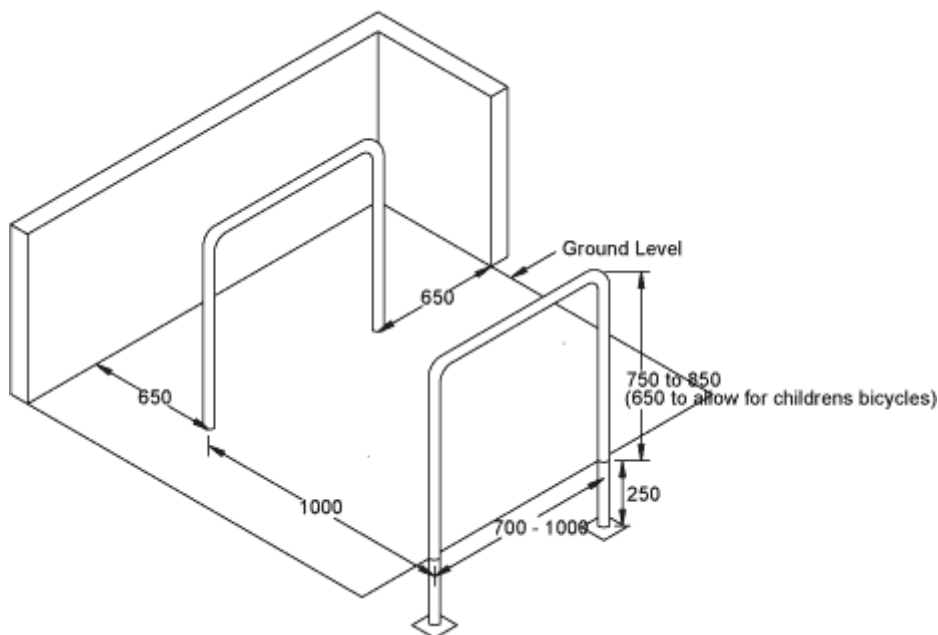

3.204 Parking provision should be considered in relation to any travel plan associated with a development proposal. Please refer to Section DG17.

3.205 Please refer to [Traffic Advisory Leaflet 5/02](#) for further information on cycle parking.



### Section DG17: Considering parking provision together with transport assessments and travel plans

3.206 You should not consider vehicle, motor cycle or cycle parking provision in isolation from travel plans. The level and design of on-site parking and any proposed travel plan measures should reflect and complement each other. The 6CsDG board is currently developing its own guidance on preparing travel plans. In the meantime, you can find some interim guidance in the [Transport Assessment Guidelines](#) in Part 7, appendix C.



# The 6Cs Design Guide

3.207 For employment developments and other developments where travel plans are required, we will normally expect the development to include complementary facilities for motorcyclist and cyclists, for example, secure lockers (for storing clothes, and so on), showers and changing rooms.



## Section DG18: Residential developments served by private drives and areas

- [Principles](#)
- [General geometry for site access to the external road network](#)
- [General layout of a private residential development](#)
- [Construction standards for private drives](#)
- [Garages and gated accesses](#)

3.208 This section provides design guidance on private drives and areas. For guidance on the [Advance Payments Code \(APC\)](#), please see [Part 5, Section ANR2](#).

### Principles

3.209 For developments of more than five dwellings, we will encourage developers to create, whenever possible, 'road' layouts that are to an [adoptable](#) standard and that will be offered for adoption. We will not normally adopt developments of five or less dwellings.

3.210 For developments of six or more dwellings, you should remember the implications both for yourself and house purchasers if we do not adopt the roads, for example:

- future maintenance liabilities;
- public liabilities
- street cleansing;
- lack of specific pedestrian facilities;
- lack of or poor standard of lighting, drainage and so on;
- we have no powers under the Highways Act; and
- the police have no powers to remove obstructions.

Poorly-maintained private areas can also detract from the quality and appearance of a development.

3.211 Private developments should normally be in the form of a cul-de-sac. You should try to avoid private 'through' routes as they are more likely to be used by the general public, possibly adding to the liabilities and future problems for residents.

3.212 For private developments of six dwellings or more, we will normally serve a notice on you with an assessment of the cost of the proposed roadworks under the Advance Payment Code (APC), to protect frontagers' interests. The cost of this will reflect the cost of the proposed street works and you should construct the works to an appropriate standard.

## The 6Cs Design Guide

However, because APCs have been served and money has been paid or retained, we are not indicating any future intention to [adopt](#) and maintain the street works at public expense. Please see [Part 5, Section ANR2](#) for more information.

3.213 If you clearly indicate that the development roads are to be private, we may also require:

- you to deposit a map with us under Section 31 (6) of the [Highways Act 1980](#) identifying the roads which are to remain private (and any to be adopted too as appropriate);
- you to erect road signs indicating that the roads are unadopted and to maintain the signs for as long as the roads remain unadopted, all at your expense;
- evidence that you have made clear to potential purchasers of the dwellings on unadopted roads what the status of the road will mean to them in practice; and
- evidence that you have secured future maintenance of the roads, for example, a unilateral undertaking by you under Section 106 of the [Town and Country Planning Act](#) to set up a maintenance company;
- you to indemnify us against future petitioning by residents to [adopt](#) their road under Section 37 of the [Highways Act 1980](#), where the road joins together two adopted highways\*; and
- the boundary between the private road and the publicly-maintained highway to be clearly marked by a concrete edging, boundary posts or similar.

\*Note: The indemnity should normally be a legal covenant placed on the properties to prevent petitioning. We must approve the wording of the covenant.

### General geometry for site access to the external road network

3.214 **Note:** in all cases, the proposed development and its location must be acceptable to us in principle and highway safety must not be reduced.

On roads with a speed limit of 40mph or higher, or where vehicle speeds are more than 40mph:

- we will encourage a development to be served by a road with an adoptable layout and access designed in line with the appropriate section of the [Design Manual for Roads and Bridges](#); or
- where we accept that there is good reason why an adoptable layout cannot be achieved, the private drive and site access must be purpose-designed to a standard acceptable to us.

For all roads where the speed limit or recorded vehicle speeds is less than 40mph, even where you can demonstrate that you cannot achieve any form of adoptable layout or you do not want your development roads to be adopted (despite the implications in [paragraph 3.213](#) above), you must still design the site access point to make sure that it does not affect the safety and efficient functioning of the highway or otherwise affect road users. (It will normally need to be designed in accordance with the Manual for Streets 1 and 2 or other standard acceptable to us.) Please see [appendix E](#) (for additional information on private areas).

# The 6Cs Design Guide

For private developments of six dwellings or more, we will normally serve a notice on you with an assessment of the cost of the proposed roadworks under the Advance Payments Code (APC), to protect frontagers' interests. Please see [Part 5, section ANR2](#) for more information.

3.215 You should provide the site access point in line with either Figure DG20 or Figure DG21, depending on the scale of the development. Also depending on the scale of the development, you will need to obtain our specific approval for the construction details of the access. The access will only be acceptable if you have a maintenance agreement planned or in place.

**Figure DG20 Unadopted shared drive serving up to 25 dwellings**

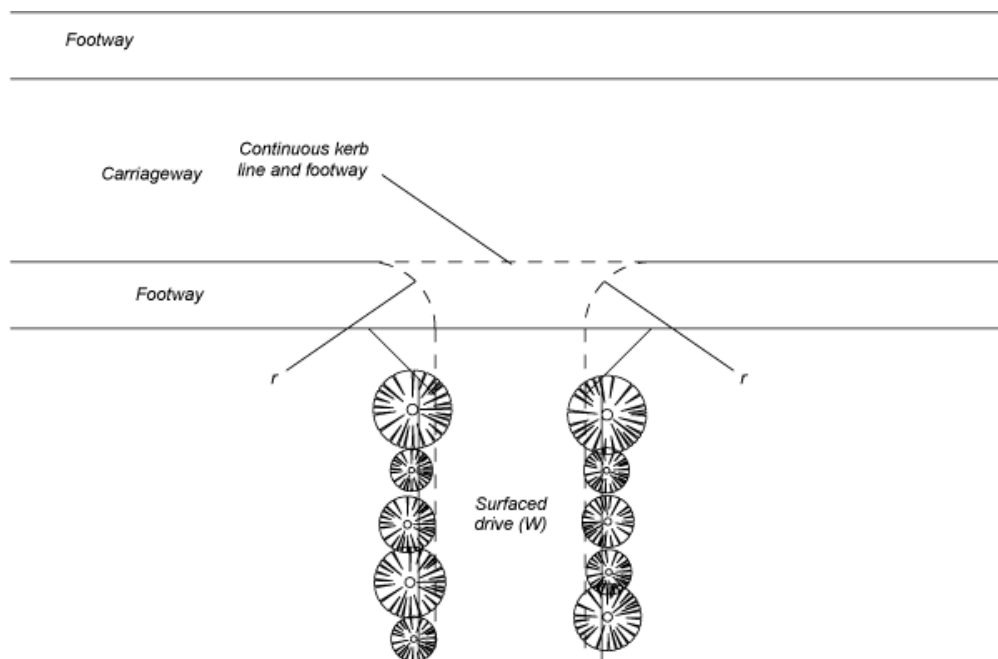

<p><b>Minimum effective width (a)</b></p>	<p>Single dwelling = 2.75m            Two to five dwellings = 4.25m for a minimum distance of 5m behind the highway boundary.             Six to 25 dwellings = 4.8m for a minimum distance of 5m behind the highway boundary<sup>(a)</sup>             (In all cases add 0.5m if bounded by a wall, fence, hedge, line of trees or other similar obstruction on one side, 1m if bounded on both sides. See also paragraph 3.219 about access for refuse collection and 3.220 about access for emergency vehicles.)</p>						
<p><b>Minimum drop crossing (b)</b>   <b>Single dwelling</b>   <b>2 to 5</b></p>	<p>For lightly trafficked residential streets (c). For classified or highly trafficked streets (d)</p> <table border="0" style="width: 100%;"> <tbody> <tr> <td style="width: 50%;">4 dropped kerbs (3.7m)</td> <td style="width: 50%;">7 dropped kerbs (6.4m)</td> </tr> <tr> <td>6 dropped kerbs (5.5m)</td> <td>8 dropped kerbs (7.3m)</td> </tr> <tr> <td>8 dropped kerbs (7.3m)</td> <td>10 dropped kerbs (9.2m)</td> </tr> </tbody> </table>	4 dropped kerbs (3.7m)	7 dropped kerbs (6.4m)	6 dropped kerbs (5.5m)	8 dropped kerbs (7.3m)	8 dropped kerbs (7.3m)	10 dropped kerbs (9.2m)
4 dropped kerbs (3.7m)	7 dropped kerbs (6.4m)						
6 dropped kerbs (5.5m)	8 dropped kerbs (7.3m)						
8 dropped kerbs (7.3m)	10 dropped kerbs (9.2m)						

## The 6Cs Design Guide

<b>dwelling 6 to 25 dwellings</b>	
<b>Vehicle visibility splays</b>	As in Table DG4, measured from a set back of 2.4m
<b>Pedestrian visibility splays</b>	2m by 2m both sides (no planting permitted)
<b>Gradient</b>	Preferably not greater than 1:20 for first 5m, (for 6-25 dwellings not greater than 1:30 for the first 10m), and should never exceed 1:12m
<b>Surfacing</b>	Bound material, for example, bituminous or concrete, or block paving for at least the first 5m

(a) If the driveway length is more than 25m, its minimum width should be 5m (plus any widening where bounded by walls) to enable access by refuse vehicles

(b) In certain circumstances, such as when parked vehicles restrict access, it will be necessary for a longer drop crossing to be provided. You may need to demonstrate an access is suitable by providing an appropriate vehicle swept path assessment.

(c) Typically this includes streets which primarily serve a place function and have 85th percentile speeds of 30mph or less and where encroachment on the opposite traffic lane when exiting the site is not considered to create a safety hazard.

(d) Typically this includes streets which primarily serve a movement function and have 85th percentile speeds of 40 mph or less and where encroachment on the opposite traffic lane when exiting the site should be minimised.

# The 6Cs Design Guide

**Figure DG21 Unadopted shared drive serving more than 25 dwellings**

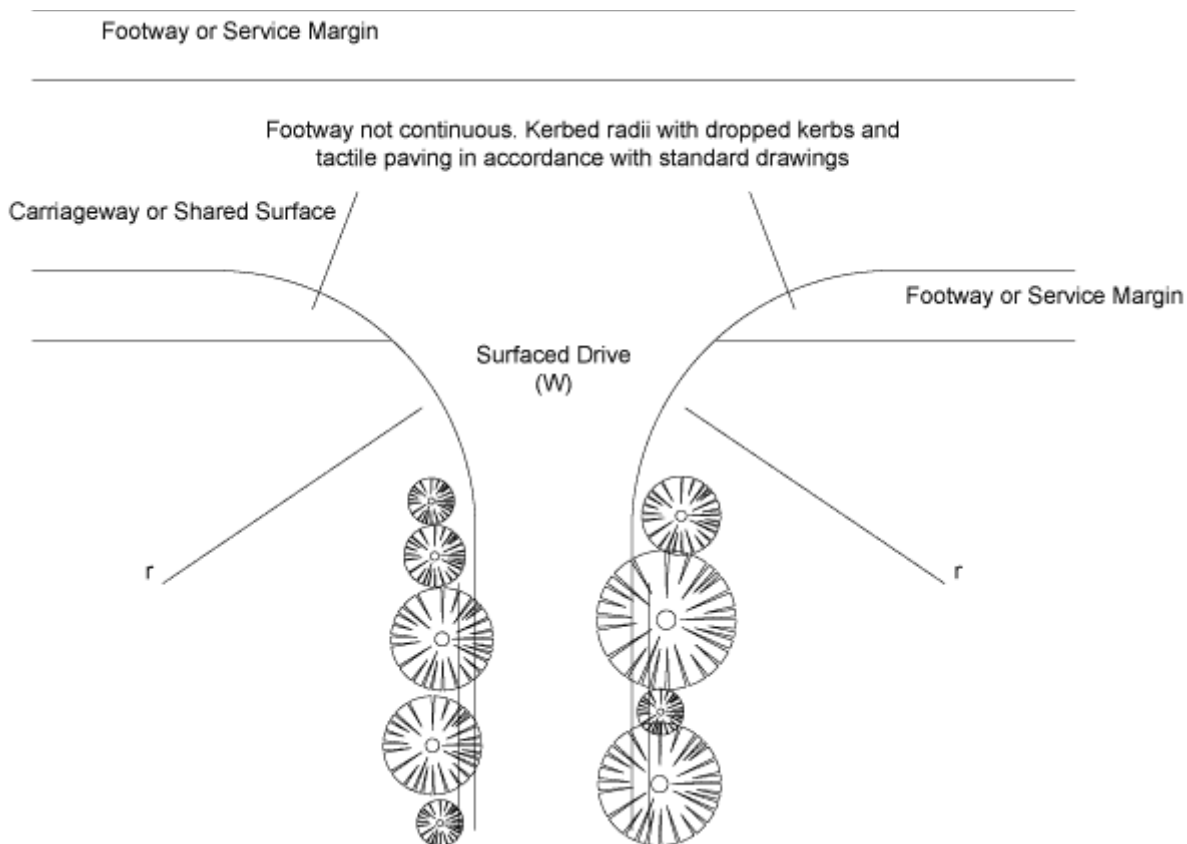

Access serving more than 25 dwellings	
Minimum effective width (w)	5.5m
	Add 0.5m if bounded by a wall on one side, 1m if bounded on both sides.  See also <a href="#">paragraph 3.218</a> about access for refuse collection and <a href="#">3.219</a> about access for emergency vehicles
Minimum kerbed radii (r)	6m
Vehicle visibility splays	As in <a href="#">Table DG4</a> , measured from a set back of 2.4m
Pedestrian visibility splays	2m by 2m both sides (no planting permitted)
Gradient	Preferably not greater than 1:20 for the first 5m, and should never exceed 1:12
Surfacing	Bound material, for example, bituminous or concrete, or block paving for at least the first 5m

## The 6Cs Design Guide

3.216 On busy roads (generally with peak-hour traffic flows of more than 300 vehicles an hour), any gates should be set back at least 5m from the highway boundary and should open inwards only.

3.217 If you cannot achieve layouts to Figure DG20 and Figure DG21 we may recommend refusal of your proposals on grounds of safety or dangers to the public, as appropriate.

### General layout of a private residential development

3.218 Even if a road is not to be [adopted](#) you should still seek to make sure that:

- your layouts are safe (both in terms of road safety and personal safety);
- your layouts are accessible to all likely users, including those with mobility impairments; and
- suitable long-term maintenance arrangements are in place.

Turning facilities will be required:

- where a proposed development takes access from a road with a speed limit above 40 mph; or
- for roads subject to speed limits less than 40 mph on any road carrying 300 vehicles per hour at its peak

Elsewhere, turning facilities will not normally be required unless road safety would be compromised.

### Figure DG22 Private drive turning facilities - typical layout

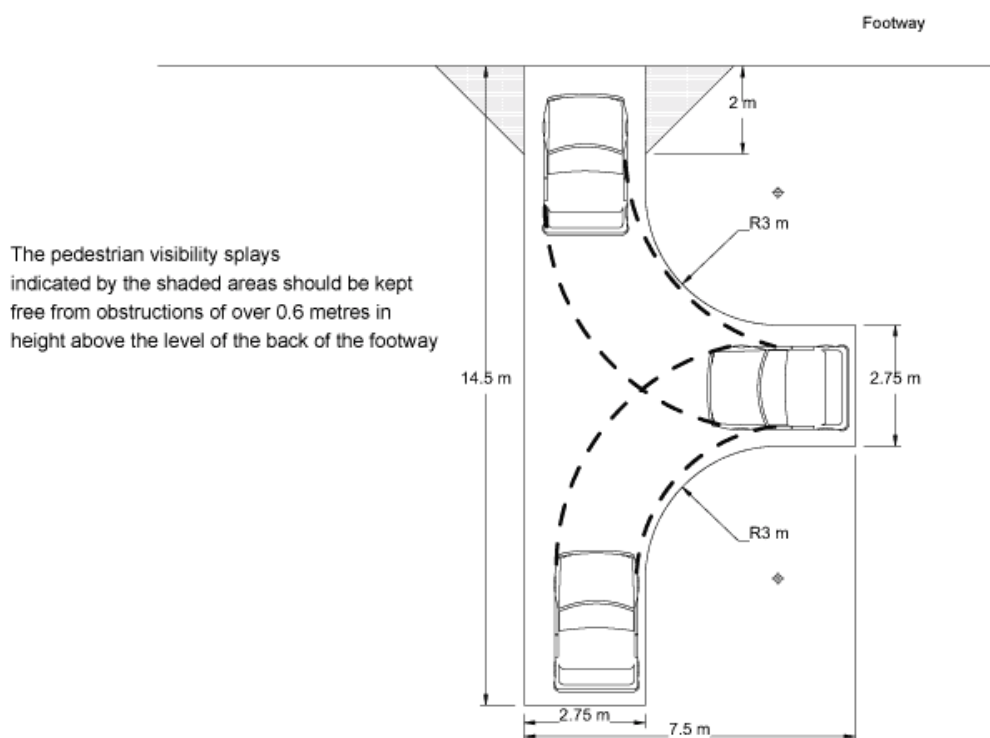

## The 6Cs Design Guide

3.219 For long drives and accesses, you should consult [BS5906, 2005](#), which sets out maximum carry distances of 25m for refuse collection. Where this distance is exceeded, the British Standard recommends:

- a minimum drive width of 5m;
- providing turning heads within the site; and
- constructing the drive so it can carry a refuse vehicle.

The layout of the development should include measures to make sure that parked vehicles do not stop the use of any turning heads. Where 'wheelie bin' collection methods are used, you should consider providing a communal collection point within the site, close to the highway.

3.220 Where a development is situated more than 45m from the highway, you must cater for emergency vehicles by constructing the drive and any turning areas so they can cater for a commercial or service vehicle. The minimum width for access should be at least 3.7m (between kerbs) and fire vehicles should not have to reverse more than 20m. Your development must be in line with [British Standard BS5906, 2005](#) and [Building Regulations Approved Document B, Fire Safety 2006](#). You should also take into account the comments about parking in [paragraph 3.215](#).

3.221 You should also follow the general guidance contained in this part of the document on personal safety and designing-out crime, and you should ask the relevant police force 'Architectural Liaison Officer', the planning authority and us for guidance on proposals for specific sites. You should also make sure that you take into account the needs of people with impaired mobility.

### Construction standards for private drives

3.222 The construction standards for drives serving up to and including 5 dwellings should normally be in accordance with that for footway vehicular and field accesses as shown in standard drawing SD/11/5A. [Standard Drawings](#). In other cases, they should normally be in line with Table DG15. (Contact us for permeable pavement design.)

**Table DG15: Private road construction depths**

		Road less than 25m long serving 6 to 25 dwellings	Road more than 25m long serving 6 to 25 dwellings	Road serving more than 25 dwellings
Bituminous	Surface course CGM	30mm	30mm	40mm
	Binder course DBM	85mm	60mm	60mm
	Base DBM	-	110mm	150
	Sub-base & Capping	270mm Type 1 GSB(a)	See Table MC4, Part 4	See Table MC4, Part 4
Block Paving	Blockwork	60mm	80mm	80mm
	Bedding sand	30mm	30mm	30mm

## The 6Cs Design Guide

	(compacted)			
	Base DBM	90mm	110mm	150mm
	Sub-base & Capping	270mm Type 1 GSB(a)	See Table MC4 Part 4	See Table MC4 Part 4

### Key

CGM = Close graded macadam

DBM = Dense bitumen macadam

### Garages and gated accesses

3.223 On plot garages to individual properties should be located so:

- cars can park in front of the garage doors: and
- the garage doors can be opened while the car is on the drive (see Table DG16);

without the cars obstructing the highway, including any footway or turning facilities.

3.224 In the interests of urban design, garages should not dominate the street scene. Where an integral garage is proposed (that is, it is part of the house), you should hold early discussions with the planning authority on the design of the garage, the house and elevation of the property. The [Manual for Streets](#) documents suggest that keeping garages and parking areas level with the main building line can be beneficial to the townscape, but, a planning authority may require garages to be located behind houses and may not encourage integral garages.

**Table DG16: Garage set-back distances**

Garage door type	Minimum distance from highway boundary
Roller-shutter, sliding or inward opening	5.5m
'Up-and-over'	6.1m
Hinged, outward opening	6.5m

Where an access is to be gated, the gates should be set back 5m where they open inward and 6m where they open outwards. This is to ensure that the public highway (particularly areas used by pedestrians) is not obstructed if a vehicle is parked on the access in front of the gates.

3.225 Garages should preferably have the following minimum internal dimensions.

- Standard single = 6m x 3m, with minimum door width of 2.3m
- Use by disabled = 6m x 3.3m with minimum door width of 2.8m
- Double = 6m x 6m, with minimum door width of 4.2m.

If a dwelling has no separate [parking for cycles](#), it may affect whether we consider that the garage should be counted towards parking provision.



# The 6Cs Design Guide



## Section DG19: Employment and commercial developments served by private drives and areas

- [Principles](#)
- [General geometry for site access to the external road network](#)
- [General layout of a private industrial or commercial development](#)

3.226 This section provides design guidance on private drives and areas. Separate guidance is currently being prepared to cover procedures for serving and paying monies under the [Advance Payment Code](#).

### Principles

3.227 For multiple-building, multiple-occupation developments (developments occupied by more than one company) we will encourage you to provide road layouts that are to an [adoptable](#) standard and offer them for adoption whenever possible. We will not normally adopt single-occupancy developments.

3.228 Except for [exempted developments](#), we will serve notice under the Advance Payment Code (APC) for all industrial and commercial developments to protect frontagers' interests. The cost of this will reflect the cost of the proposed street works and you should construct the works to an appropriate standard. However, because APCs have been served and money has been paid or retained, we are not indicating any future intention to adopt and maintain the street works at public expense. The requirements of [paragraph 3.212](#) may also apply.

### General geometry for site access to the external road network

3.229 Even where you can demonstrate that you cannot achieve a form of [adoptable](#) layout or you do not want your development roads to be adopted, you should still design the site access point to make sure that it does not affect the safety and efficient functioning of the highway or otherwise affect road users.

3.230 You should normally design site access in line with the appropriate parts of the [Design Manual for Roads and Bridges](#) and our [Specification](#) and [standard drawings](#), unless the road to which your development connects falls within the definition of a road (street) as set out in [appendix L](#).

3.231 Office developments (use class B1) up to 3000m<sup>2</sup> gross floor area (GFA) may be served by a dropped-kerb access arrangement as shown in Figure DG23. However, if you choose this option, you should note that we will recommend imposing planning conditions that restrict any change of use to general employment (use class B2 to B8). Depending on the scale of the development, you will need to obtain our specific approval for the construction details of the access.

# The 6Cs Design Guide

**Figure DG23 Unadopted access serving up to 3000m<sup>2</sup> (GFA) of offices**

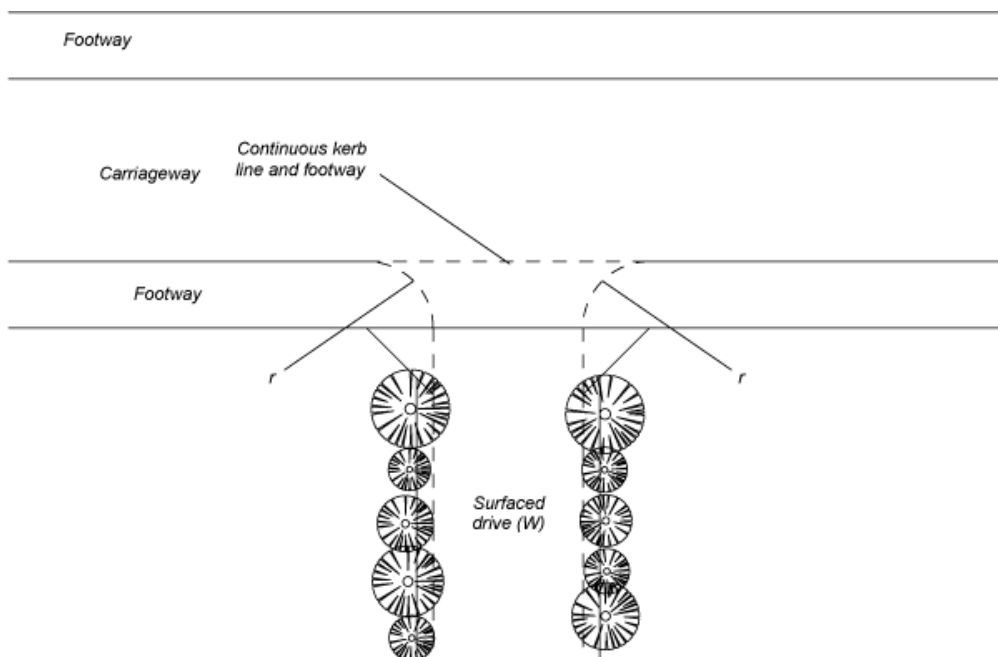

<b>Minimum effective width (w)</b>	6m (Add 0.5m if bounded by a wall on one side, 1m if bounded on both sides.)
<b>Minimum control radii (r)</b>	6m
<b>Vehicle visibility splays</b>	As in <a href="#">Table DG4</a> , measured from a set back of 2.4m
<b>Pedestrian visibility splays</b>	2m by 2m both sides. No planting permitted
<b>Gradient</b>	Preferably not greater than 1:20 for first 15m, and should never exceed 1:12
<b>Surfacing</b>	Bound material, for example, bituminous or concrete, or block paving for at least the first 15m

3.232 Regardless of the access type, you should provide separate footways or pedestrian routes within the site to minimise the safety risks of pedestrians coming into contact with HGVs. This could be in the form of footways or routes marked on the ground and segregated by bollards or railings.

3.233 Where any gates are to be provided, they should open inwards and be set back a distance appropriate to the type of vehicle likely to require access to the development.

## General layout of a private industrial or commercial development

3.234 Even if a road is not to be [adopted](#) you should still seek to make sure that:

- their layouts are safe (both in terms of road safety and personal safety);

## The 6Cs Design Guide

- they are accessible to all likely vehicles and other users, including those with impaired mobility; and
- suitable long-term maintenance arrangements are in place.

3.235 You must also take into account the requirements of [BS5906 2005](#) and [Building Regulations Approved Document B, Fire Safety 2006](#), with regard to access for refuse collection and emergency vehicles (see paragraphs [3.221](#) and [3.222](#)). You should design and construct any turning areas within 50m of the access junction to the [adoptable design guidance](#) to minimise the risk of vehicles having to reverse out of the development on to the public highway. The layout of the development should include measures to make sure that parked vehicles do not reduce the use of any turning heads or areas.

3.236 You should also follow the various general guidance contained in this part of the document on personal safety and designing-out crime, and you should seek guidance from the relevant police force 'Architectural Liaison Officer' on proposals for specific sites. You should also make sure that you take into account the needs of people with impaired mobility. For car parking areas, you should follow the guidance in [Section DG14](#).

### **Section DG20: Marking the highway boundary**

3.237 Wherever the extent of the [adoptable highway](#) is not clear – for example there is no wall, fence, or [footway](#) edge – you must install an agreed form of boundary marking.